

# Sail carefree

green&clean warewashing solutions



# 4 solutions guaranteed satisfaction

Undercounter, hood type, pot & pan washer and rack type warewashers are ideal solutions for customers that require high performance – and low running costs. Electrolux Professional offers products that deliver outstanding results, and ensure reliable operation

**40**  
racks/hour



green&clean  
**Undercounter  
Dishwashers**

**80**  
racks/hour



green&clean  
**Hood Type  
Dishwashers**

**20**  
racks/hour



green&clean  
**Pot and Pan  
washer**

**150/200**  
racks/hour



green&clean  
**Dual Rinse** Single and double tank

# Best-in-class performance

Are you aiming to cut running costs, have sparkling clean, sanitized dishes, and enjoy a product that is easy to use and maintain? Electrolux Professional's answer is the new green&clean range of warewashers



**Green**  
Low running costs



**Clean**  
Brilliant results

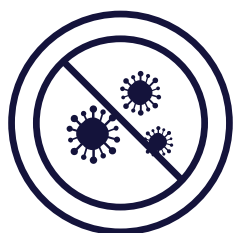

**Safe**  
Guaranteed sanitation



**Easy**  
Simple operation and maintenance



**Let us ride with you**

Are you looking for the user manual or do you need other support materials?

E-Tandem™, the Electrolux Professional Digital Service will help you get immediate access to numerous tools.

Simply scan the QR code on the front of the machine and start your ride.

# green&clean Undercounter Dishwashers

40  
racks/hour

Green, clean, safe and easy.  
The ideal solution for high performance and low running costs.



## Less consumptions, more savings

Consume **only 2,5 liters/cycle** and **save € 730** per year\*.



## Excellent washing and rinsing performance

**Total detergent removal** and **maximum performance** thanks to double upper and lower washing and rinsing arms.



## Sanitation means safety

**Superior hygiene** and **optimal rinsing** results with **Wash-Safe Control** that guarantees a constant 84 °C rinse temperature\*\*.

**USPHS Vessel sanitation program - Construction guidelines compliant\*\***



## Easy and ergonomic

**Safe and ergonomic** counterbalanced door for soft opening and closing with **easy to grip** handle.

**Self-diagnosis** and **constant monitoring** thanks to user-friendly electronic control with highly visible temperature display.



\* Cost savings are calculated by Electrolux Professional Lab which is accredited by UL and Intertek. Comparison made between green&clean Undercounter Dishwasher and an equivalent conventional machine using **3.5 liters/cycle** per rinsing, 70 cycles/day, 300 annual working days, 15 °C inlet water.

\*\* On selected models.



# Savings and sustainability



Electrolux Professional offers a unique global competence in technology, design, manufacturing and service, aiming to reduce running costs with less impact on the environment.

Exceptional savings:  
**€ 730\*** per year

Enjoy the € 730\* per year in your pocket thanks to the savings made in water, energy, detergent and rinse aid and still guarantee optimal performance.

## green&clean

the perfect balance between optimum performance and low running costs.



### Low water consumption

2.5lt/cycle of fresh water are needed for rinsing regardless of water inlet conditions.



### Low energy consumption

Drops by 25% since less water is used for rinsing.



### Less detergent and rinse aid consumption

Much smaller quantities are needed.

\* Cost savings are calculated by Electrolux Professional Lab which is accredited by UL and Intertek. Comparison made between green&clean Undercounter Dishwasher and an equivalent conventional machine using 3.5 liters/cycle per rinsing, 70 cycles/day, 300 annual working days, 15 °C inlet water.

# Make the best first impression



Excellent washing and rinsing performance with total detergent removal. The ideal dishwasher for cleaning plates, cups, utensils, trays, gastronomic containers and cutlery.

## Clean Items guaranteed

**No areas of the washing chamber remain untouched!**

The powerful washing circuit guarantees **optimal washing results** regardless of where the items are placed, thanks to the unique shape of the spray nozzles and the upper and lower rotating arms.

## Perfect rinsing performance

The **slanted wash arms\*** and the 4-second pause after washing and before rinsing **ensures** the wash water **no longer drops** on the clean dishes after the rinse cycle.

**No more damage to glassware** with the "Soft Start" feature which reduces the water pressure on the items at the start of the wash cycle.



The one you can count on for optimal results

\* On selected models

# Safety comes first

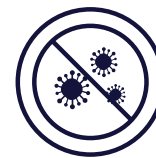

Superior rinse quality thanks to Wash-Safe Control that guarantees a constant rinse temperature of 84 °C and water pressure independent from the mains.

## 84 °C

constant rinse temperature for perfect hygienic conditions.



### Guaranteed sanitation

Sanitation and rinse quality are guaranteed with **green&clean's Wash-Safe Control**.

Bacteria find their ideal condition for growth in an environment with a temperature between 20 and 60° °C (max. 75 °C). Wash-Safe Control **eliminates bacteria** thanks to the constant rinse temperature of 84 °C.

The Wash-Safe Control light turns green to indicate rinsing has been performed correctly.



## Simply clean. Worry-free hygiene

Avoid bacteria proliferation when the machine is not in use. The fully automatic self-cleaning cycle sanitizes the washing chamber with hot water and then completely empties the boiler.

USPHS Vessel sanitation program - Construction guidelines compliant\*

\* On selected models



# Designed to perform



Forget the hard work and fatigue. green&clean Undercounter Dishwashers make work operations lighter and easier to keep you smiling all day long.



## New design with ergonomics in mind

Sleek and modern look to complement the design of pubs and bars.

**Soft opening and closing** with the lightweight counterbalanced door equipped with springs.

**Quiet working environment** and **less heat dispersion** thanks to the double skin insulated door and cabinet.\*

Ergonomic handle for **easy operations**.

**Quick and easy maintenance** thanks to frontal access to components. **No need to move the machine.**

## User friendly control panel with clear icons puts everyone at ease

Choose between **3 cycles** to wash any kind of residue.

The washing and rinsing cycle **times and temperatures can be fully customized** to meet specific customer requirements.



**Wash tank filters** can be **easily removed** without having to remove the washing and rinsing arms.



# Reliability in first place

Durability, reliability and long life. green&clean Undercounter Dishwashers give you more than what you expect from a dishwasher.



#### Round corners

Wash tank with rounded corners to avoid dirt traps.

#### Easily removable wash/rinse arms

Wash and rinse arms are easily removable for cleaning.



#### Boiler resistant to chlorinated water

The boiler, being made of A304L, is resistant to chlorinated water and is welded in an inert atmosphere to avoid contamination during the production process.



#### Highly durable water hose

The water supply hose has metal connections to withstand high water pressure and accidental shocks during installation.



#### Failproof chemical tube connection

Highly resistant and long lasting detergent and rinse aid tubes with a unique failproof connection for fast, easy assembly and maintenance.



# green&clean Hood Type Dishwasher

With the lowest running costs in the industry, and guaranteed great results load after load, the Electrolux Professional green&clean hood type dishwasher offers best-in-class eco-friendliness and reliability. It is the perfect solution for highly efficient warewashing for diverse needs



## Green



### Low running costs

Save 1.040 € per year; the green&clean hood type dishwasher uses less water, electricity, detergent and rinse aid

### Top of the class energy saving

Maximum energy saving is guaranteed thanks to the highly efficient Energy Savings Device\*: up to 25°C rise for free

\* available only on selected models



## Clean



### Brilliant results in any condition

Perfectly clean plates after every cycle are guaranteed by **CLEAR BLUE**: a multi-stage filtering system keeping the water in the tank clean in every duty condition. A perfectly working system to keep water free from food residue allowing amazing results



80  
racks/hour



Safe

## Guaranteed sanitation

Sanitation and rinse quality are guaranteed with green&clean's **WASH•SAFE CONTROL**. This feature maintains a constant rinse temperature of 85 °C thanks to a hydraulic system with a standard air gap and a rinse pump

USPHS Vessel sanitation program -  
Construction guidelines compliant\*



Easy

## Simple use and maintenance

The control panel can be **easily read and accessed without bending**, due to its innovative position on the corner of the warewasher



\* available only on selected models

# Water and energy savings



Superior performance combined with reduced consumption of water, energy and chemicals



**SAVE**  
1.040 €  
/year

**=**



Less water

**=**



Less energy

**=**



Less detergent and rinse aid

**Only 2 liters per cycle**

**Only 0.18 kW/h per cycle heating up to rinsing temperature**

**Only 4 g of detergent and 0.2 g of rinse aid per cycle**

## Cut running costs with rinsing done right: only 2 liters of water per cycle

The entirely stainless steel rinsing arm nozzles spray in a fixed direction and are positioned asymmetrically for better jet patterns.

Using sprayed water to rinse the wares is highly efficient

## Maximum energy Saving\*\*

The highly efficient Energy Saving Device increases savings on energy consistently (up to 25°C rise for free). No ventilation is needed. The system is extremely fast: it takes only 11" to recover the steam energy

## Zero Lime system\*\*

The device is very effective with low energy consumption (scale reduces heat exchange). It guarantees maximum efficiency (all hydraulic components get de-limed). This means no need of manual de-liming anymore



\*cost savings are calculated by comparing the Electrolux Professional green&clean hood type dishwasher to equivalent competitor machines on the market, washing 100 racks/day over a 360-day period \*\*available only on selected models



# Gleaming results



The hood type warewasher features a highly efficient design: it uses less water, but to great effect, for brilliant washing and rinsing results



## No more drops on clean dishes

Slanted wash arms and a 4-second pause after washing, and prior to rinsing, ensures the wash water does not drip on the clean dishes during the rinse cycle



## Efficient washing

Better washing means spotless dishes. The wash nozzles are asymmetrically positioned, and designed to clean items efficiently



## Special power nozzle

For ideal washing and rinsing, each part of the warewasher must function well.

For example, the power nozzle on the edge of the wash arm precisely controls rotation speed

**80** or **1,440**  
racks/hour dishes/hour

**perfectly cleaned  
thanks to an efficient  
water jet pattern**

# Simply safe guaranteed sanitation

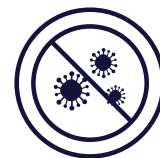

Reliably excellent sanitation for peace of mind. Outstanding rinse quality is achieved by a consistently high water temperature, and by water pressure independent from that of the mains



## Perfect sanitation

Sanitation and rinse quality are guaranteed with green&clean's **WASH•SAFE CONTROL**.

This feature maintains a constant rinse temperature of 84 °C, thanks to a hydraulic system with a standard air gap and a rinse pump

# 84 °C

constant rinse  
temperature  
means maximum  
cleanliness

## Top industry certifications

### Certified performance

The green&clean hood type warewasher offers certified performance, and requires just 2 liters of water for rinsing

Compliant with  
NSF/ANSI 3 - DIN 10512

Sanitation and performance  
are compliant with both:

- ▶ NSF/ANSI 3 standard for commercial warewashing equipment;
- ▶ DIN 10512 German norm concerning food hygiene equipment for commercial dishwashers with one tank



# NSF/DIN 10512

**USPHS Vessel sanitation program -  
Construction guidelines compliant\***

\* on selected models

# Easy to install and maintain



The green&clean hood type dishwasher is the only washer to feature a corner control panel for maximum visibility and ease of operation

## Easy operation

The innovative angular position of the control panel makes it exceptionally easy to see. Boiler settings can be adjusted directly via the control panel

Obtain the perfect washing results in all conditions by choosing the concentration of detergent and rinse aid

The panel is easy to read and accessible without bending thanks to its position on the corner of the machine



## Easy maintenance



**Cleaning the warewasher is safe and simple** thanks to removable basket supports, tank filter and wash/rinse arms

**A 24-liter pressed tank** at the front of the machine makes cleaning faster and easier. The tank has **rounded corners**, so no dirt is trapped



# Pot and Pan washer

Electrolux Professional Pot & Pan Washers are the ideal solution for demanding customers looking for high performing machines. Perfect for cleaning pots, pans, utensils, trays, gastronorm containers as well as butchery and bakery trays. Flexible and ergonomic operation, offering the maximum in sanitation and washing results.



## Green



### Double skin, more savings

- ▶ Energy savings during stand-by time, due to double skin insulation construction.



## Clean



### Outstanding cleanability

- ▶ Powerful wash pumps ensure clean pots, pans and containers
- ▶ Ergonomic design to easy access and clean the machine





**20**  
racks/hour



## Safe

### Guaranteed sanitation

**WASH•SAFE CONTROL.** for constant efficiency. The ultimate answer to safety, hygiene, energy saving and low running costs.

USPHS Vessel sanitation program -  
Construction guidelines compliant



## Easy

### Flexibility

- ▶ Easy and quick installation of the machine in any location without the need to open the machine or install additional accessory
- ▶ Fully equipped with drain pump, detergent and rinse aid dispensers

### Ergonomics

- ▶ Easy loading and unloading the rack even with heavy items
- ▶ Slowly and smoothly open and close the door with less effort
- ▶ Silent operation



# Double skin, more savings



Double skin insulation construction means more energy saving during stand-by time.



# Outstanding cleanability



## Guaranteed cleaning, top performances

### 3-sided wash arms

- ▶ deep cleaning of large items (with "click-in/click-out" device, if it's not required by the operator)
- ▶ more powerful wash water for the best cleaning of soiled items

### Internal shape of hood

- ▶ prevents "dirty" drops of water from falling on the clean items, once the wash cycle has finished

### Pressure adjustable device

- ▶ Obtain the best performance adjusting the wash water pressure of both, upper and lower washing arms (depending on items)



**Full tank coverage** with stainless steel wash tank filters, to prevent coarse debris from entering the wash water system, for **perfect washing result.**

# Safe and secure

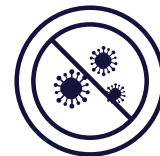

## Wash Safe Control = excellent rinse quality.

Rinsing circuit sanitizes all washed items at a constant temperature of 84 °C, regardless of the network's water temperature.

Atmospheric boiler, coupled with rinse booster pump, ensures a strong constant rinse water pressure, even when water mains pressure is low.

Fully automatic self-cleaning cycle sanitizes washing chamber with hot water after use

## Perfect sanitation

Sanitation and rinse quality are guaranteed with green&clean's **WASH•SAFE CONTROL**.

This feature maintains a constant rinse temperature of 84 °C, thanks to a hydraulic system with a standard air gap and a rinse pump

Wash  
Safe  
Control

Equipped with a **built-in drain pump which completely drains water**, even if at a high level, thus avoiding odors and bacterial proliferation.

**Boiler drain down facility to evacuate "dirty" water for added hygiene in periods of non-use**

USPHS Vessel sanitation program  
Construction guidelines compliant





# Designed specifically for you



- ▶ **Filters** can be removed without taking out the washing and rinsing arms
- ▶ **Door handles** are ergonomically designed to be grabbed from any position
- ▶ **Stainless steel slide-out basket** with rollers for easy handling
- ▶ **Door folds down 180°** to facilitate cleaning



High opening with smooth door movement



180° frontal door opening

## Flexibility



All models are designed to accept internal and external dosing equipment:

- ▶ Dosage quantities are programmable via the electronic control panel
- ▶ 3 wash cycles: for light, medium and heavy soiled items.
- ▶ Infinite cycle for continuous washing
- ▶ External connection box allows rapid on-site changing of voltage
- ▶ Electronic control panel allows on-site personalization of washing & rinsing cycle times & temperatures depending on the customer's needs

# green&clean Rack Type Dishwasher

The new **green&clean Dual Rinse Rack Type Dishwashers** guarantee one of the **lowest running costs in their category** and consistent results load after load. The perfect example of sustainability, reliability and ease of use.



## Green

Consume only 0,9 - 1,0 liters/rack in a compact size and save €2.900\*\* a year.

green&clean's innovative rinse circuit uses less water, less electricity, less detergent and less rinse aid.

**Ventless solution:** Energy Saving Device works with chill water in close circuit for steam abatement



**Consistent performance and maximum efficiency** over time with automatic ZeroLime\* descaling device

**FIRST**  
in the industry



## Safe

### Guaranteed sanitation

Reach perfect hygiene with 85 °C constant rinse temperature. Guaranteed also with different water inlet conditions.

**USPHS Vessel sanitation program - Construction guidelines compliant**



\* Available as optional accessory

\*\* Cost savings are calculated by Electrolux Professional Lab which is accredited by UL and Intertek. Comparison made between green&clean Dual Rinse Rack Type Dishwasher and an equivalent conventional machine using **300 liters/hour** for rinsing at 10 °C inlet, for a restaurant serving 500 meals/peak hour over a 360 day period.

# 150/200

racks/hour



## Easy

### Simple to use

green&clean's touchscreen interface talks to you. Up to 24 languages and a new simple touch panel. Easy to understand technical info and guided troubleshooting for fast fixes.

### Simple to install

Fast and easy external connections (water, power and chemicals) tried and tested by Electrolux Professional Authorized Service Partner for a faster and safer set-up.

### Keep washing, no downtime

Keep washing, even if something goes wrong. No more downtime or hand washing whilst your service technician arrives, thanks to the **Non-Stop automatic backup modes**.



## Clean

### Crystal clear washing results

**Brilliant washing results** and perfectly clean plates at every use thanks to the advanced **ClearBlue** Filtering System that keeps water cleaner longer.



# Stronger roots, highest performance



When considering the cost of an investment, the up-front expense is just the tip of the iceberg. Operating costs accumulate, year after year, and make up the largest share of your expense. With **green&clean Dual Rinse Rack Type** you can save:

## +27%\* in profits

Consume only **0,9 - 1,2 liters/rack** in a compact size and **save €2.900\*** a year\*.

green&clean Dual Rinse's innovative rinse circuit uses less water, less electricity, less detergent and less rinse aid.

## -22% energy consumption

Save **1070 €/year** on energy and say goodbye to manual descaling. No limescale build-up means heating elements at maximum efficiency to continue performing over time with automatic **ZeroLime** descaling device\*\*.



### 22%

less energy\*



### 30%

less water\*



### 32%

less detergent  
and rinse aid\*

\* Cost savings are calculated by Electrolux Professional Lab which is accredited by UL and Intertek. Comparison made between green&clean Dual Rinse Rack Type Dishwasher and an equivalent conventional machine using **240 liters/hour** for rinsing at 10 °C inlet, for a restaurant serving 500 meals/peak hour over a 360 day period.

\*\* Available as optional accessory

# Better for you, better for the environment

green&clean Dual Rinse Rack Type guarantees high efficiency, low heat emission and consistent performance.

## Ventless solution\*

Steam releases on both sides of the machine will be captured back inside the Steam Abatement device having condensing unit working with chilled water in a close circuit. Chilled water will absorb heat from steam then release fresh air on the top of the machine.

\* according to UNI ISO EN 7730 norm, VDI 2052 guideline and DW/172 UK regulation

### Steam Abatement device

The steam stays inside the machine.

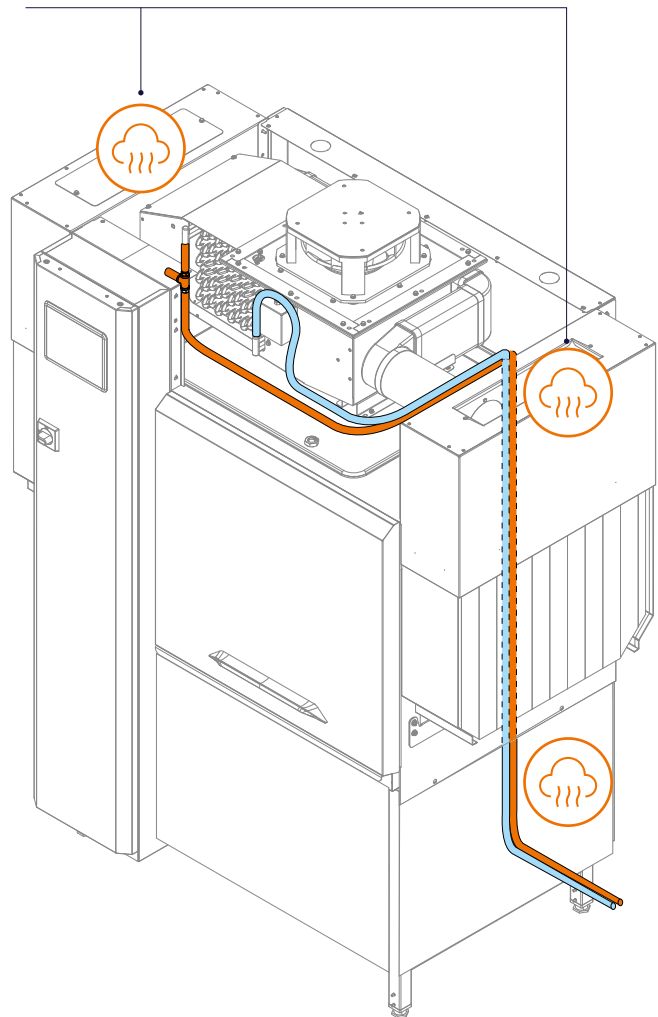

**green&clean Dual Rinse Rack Type** makes the workplace cooler and the workers happier thanks to the Steam Abatement Device which **avoids heat dispersion** into the environment.



# Crystal clear washing performance



Brilliantly clean tableware, utensils, trays and gastronorm containers. green&clean's **ClearBlue Filtering System** keeps water free from food residues.



## Outstanding washing performance

Spotlessly clean wares and no downtime to change water.

**ClearBlue Filtering System** removes all trace of food residue from the wash water thus improving detergent efficiency and giving outstanding results. With an inclined tank filter, food debris is collected, guided through a multi-stage filtering system and then flushed away.

## Clean water, always

The wash water is always clean without extra effort from the operator thanks to the **automatic wash tank dump& fill** during washing. Some 20% of the water is dumped and refilled automatically: every 150 racks for the wash tank and every 50 racks for the pre-wash tank

**95%**  
of food residue filtered means superbly clean results, less maintenance and less downtime\*.

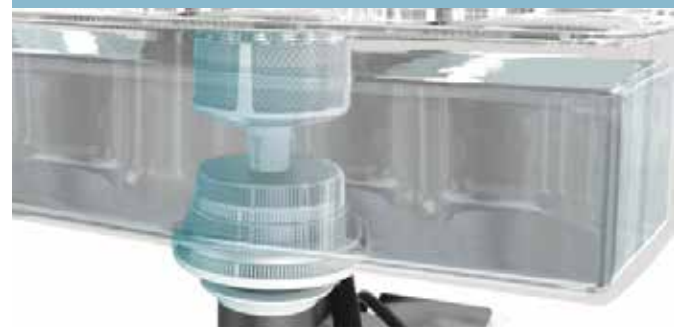

**Crystal clear washing results** thanks to the wide wash arms consistently blasting high water pressure into every corner of the machine. Sparkling results every time.



**Smooth automatic operation** thanks to an optimum distance between the curtain and rinse arm. In this way the curtains do not block the upper arm, ensuring that the rinse water thoroughly covers the complete rack.

# Safety is peace of mind



Uncompromising hygiene and sanitization with green&clean's constant high power water pressure (1 bar)

## Guaranteed hygiene at any incoming water pressure

Rinse performance is assured with (1 bar) pressure.

Incoming water pressure is stabilized by green&clean's pre-adjustable pressure valve ensuring the right rinse pressure for optimum hygiene.

Fully stainless steel rinse circuit offers greater hygiene throughout the cleaning process

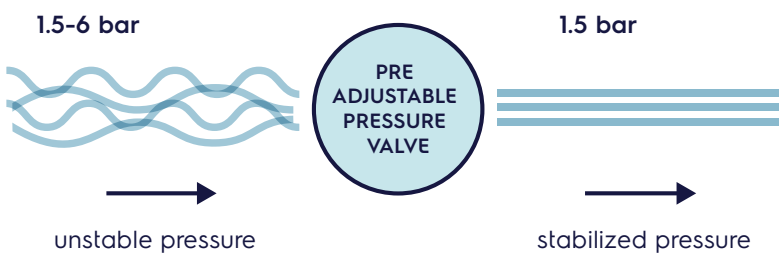

Water pressure guarantees a high powered rinse cycle for excellent hygiene

Optimum hygiene thanks to the adjustable pressure valve which stabilizes incoming water pressure to ensure the proper rinsing pressure.

## Best-in-class performance:

The new green&clean Dual Rinse Rack Type complies with:

- ▶ German DIN 10510: Food hygiene - Commercial dishwashing with multitank-transport dishwashers - Hygiene requirements, procedure testing standard for hygiene requirements of multitank dishwashers.

USPHS Vessel sanitation program Construction guidelines compliant

# The simple touch



The green&clean touchscreen interface facilitates your daily tasks. Easy operations, easy installation and simply guided troubleshooting.

## A touchscreen interface that talks your language

Using green&clean couldn't be easier. Simple graphics guide the user through the quick and easy steps to access different options. **Different users. Different information.**

Up to **24** languages and a new simple touch panel.

**FIRST**  
in the industry



Dual Rinse control panel

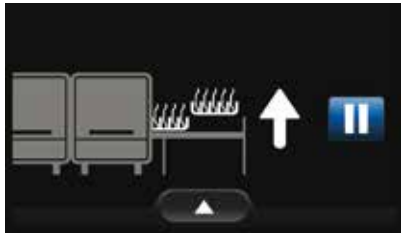

### For the operator

Simple animations and little text make everyday use foolproof



### For internal maintenance staff

Easy to access, easy to understand technical info and protected access with a level 1 password.



### For Electrolux Professional Authorized Service Partners

Faster troubleshooting at a glance, technical information and protected access with a level 2 password.



# No more downtime with Non-Stop automatic backup modes

Keep washing, even if something goes wrong. No more downtime or hand washing whilst your service technician arrives.

green&clean Dual Rinse Rack Type Dishwashers automatically adopt a different working mode, bypassing faults, to continue washing.

Built-in sensors rapidly identify any issues and activate back-up modes such as altering temperature.



1. When a warning message is notified, push the **CONTINUE** button to activate non-stop automatic backup mode.



2. Your green&clean Rack Type switches into back up mode to allow you to wash, but the **warning sign** ⚠️ reminds the operator to ask for a service check.



## Fast fixes thanks to guided troubleshooting

The machine will show you how to troubleshoot. Service intervention is only requested when strictly necessary.

**Hassle-free maintenance and repairs. No need to move the machine.** Faster check-ups and repairs with easy front access to all components.

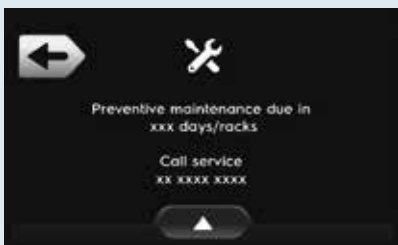

**Prevent downtime**  
The machine will automatically call for preventive maintenance checks.

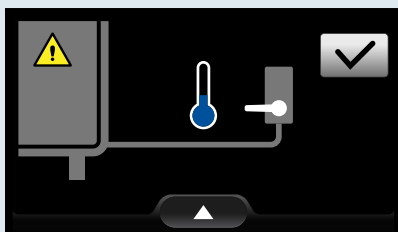

Open cold water notification

## Easy installation

No need to open panels or drill holes.

Fast and easy external connections for a faster and safer set-up with plug-in configuration.



Water connections

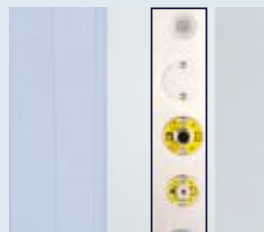

Chemical connections



# OnE Connected, your digital assistant

Connected  
green&clean  
Warewashing  
Solutions



OnE Connected helps you get top performances from your Electrolux Professional solutions. This will maximize your profits and accelerate your return on investment.



## Improve your work life

Zoom into the current status of each green&clean Warewasher from anywhere at anytime to check washing and rinsing temperatures and at which speed the machine is being used.

**Smart usage.** Use OnE Connected to know when your green&clean is on, undersized or oversized so that you can balance the process.



## Earn more

Electrolux Professional OnE Connected helps you reduce consumptions to a minimum and optimize the efficiency of your business.

**Smart upgrade of your machine.** Monitoring productivity, you discover you need a more productive warewasher to improve the process. Upgrade as you go along, green&clean warewashers grow with your business.

**Smart configuration.** Now you have all the info you need to order your next dishwasher with the right capacity for your business.



**OnE Connected  
monitors your work and  
helps you to create the  
right solution for your  
dishwashing area**



Digital platform



Customer Care



giving you



### Boost your performance

Remote speed diagnosis from anywhere: product code, serial number and any error codes to increase accuracy.

OnE Connected helps ensure maximum uptime while reducing any inconvenience for unexpected breakdowns.

For additional benefits subscribe to Essentia Service Agreement



### Maximize uptime of your equipment

OnE Connected gives you the insight to **better organize your work flow.**

Monitor the status of your green&clean warewashers, also in multiple locations using direct comparison charts in a single snapshot Track actual processing time, operator waiting time and total working time (whether hourly, daily, monthly or yearly).

The outcome will help you to organize your staff and optimize your work flow avoiding dead times.

STATUS: Blocked



**ALERT DETAILS**  
**LAST ACTIVITY**  
 User date: 11/05/2019 02:45 PM  
 Site date: 11/05/2019 02:45 PM  
**PNC / SN**  
 9CGX502026 37-92310012  
**TICKET ID**  
 171150  
**ANOMALY**  
 C12  
**DESCRIPTION**  
 Tank level sensor out of order  
**TROUBLE SHOOTING**  
 Clean the tank and remove any visible cloggin from the air trap. Switch OFF/ON and if the problem persists call service.

Organize your staff, maximize your time. OnE Connected tracks every aspect to optimize your workflow



Excellence is central to everything we do.  
By anticipating our customers' needs, we strive for  
Excellence with our people, innovations, solutions and services.  
To be the OnE making our customers' work-life easier,  
more profitable – and truly sustainable every day.

Follow us on



[www.electroluxprofessional.com](http://www.electroluxprofessional.com)

## Excellence with the environment in mind

- ▶ All our factories are ISO 14001-certified
- ▶ All our solutions are designed for low consumption of water, energy, detergents and harmful emissions
- ▶ In recent years over 70% of our product features have been updated with the environmental needs of our customers in mind
- ▶ Our technology is RoHS and REACH compliant and over 95% recyclable
- ▶ Our products are 100% quality tested by experts

