



Boosting your profitability

myPRO Laundry solutions



1 myPRO
Washers and Dryers p. 12

2 myPROzip
Washers and Dryers p. 22

3 myPRO^{XL}
Washers and Dryers p. 26

4 myPRO
Steam Ironers p. 30





We ♥ to help
you attract new
customers and
continue your
success story

Why should you sell myPRO? Simple.

More and more business owners are looking for a smart professional solution replacing domestic machines. In return they will get higher durability, greater flexibility and more peace of mind. myPRO is a sustainable and reliable investment that will serve them well for many years.

myPRO paves the way to a lot of advantages:

- ▶ **Extra business**
- ▶ **Great margins**
- ▶ **Impressive marketing tools**



myPRO Laundry solutions are at home in many segments...



myPRO is designed for small businesses that need laundry solutions stronger and faster than standard domestic appliances. Businesses that require **durable Washers, efficient Dryers and productive Finishing Equipment**, but have no need for an advanced professional solution.

myPRO offers:

- ▶ **Higher durability and flexibility**
- ▶ **Superb quality results in less time**
- ▶ **Professional benefits on a sensible budget**
- ▶ **Warranty for professional applications**

Perfect for small businesses such as

- ▶ Small Hotels and Bed & Breakfasts
- ▶ Small Restaurants
- ▶ Hairdressing and Beauty salons
- ▶ Sport and Fitness clubs
- ▶ Facility Management companies
- ▶ Out-of-home resident services
- ▶ Restaurant Chains / Franchise and more





...and
**myPROzip with
FlexiPay comfort
has its own
special areas
of application**



The new Smart Professional laundry solution for holiday accommodation and leisure facilities. With FlexiPay comfort - to connect to your most convenient payment solution.

Leisure time is precious – people on holiday want to relax and enjoy themselves being able to quickly wash and dry their garments. **Ensure your guests get the most out of their trip with myPROzip.** Whether you manage a campsite, holiday rental, youth hostel, marina or other leisure facility, your guests will love being able to freshen up their garments on the go. myPROzip combines durability with efficiency, saving you money and saving your guests time.

myPROzip offers:

- ▶ **Up to 50 % faster¹** with professional programs
- ▶ **3 times longer lifetime²** due to more durable construction with professional component
- ▶ **Great results every time** thanks to the unique Electrolux Professional **SpeedCare drum**
- ▶ **Warranty for professional applications**

¹ myPRO Washer ² Compared to domestic machines



Good reasons to choose myPRO – the smart professional Laundry solution

Faster. Cleaner. Greener.

Slow programs and inadequate or unhygienic laundry results are everyday hindrances when **domestic machines are unable to meet business needs**. This creates hassle and wastes time and money. myPRO frees up more time for small business owners to focus on what matters.

- ▶ Triple the lifetime¹ with 7,500 cycles due to durable construction with professional components
- ▶ Superb speed and flexibility with professional programs to meet a wide range of needs
- ▶ Gentle to fabric, strong against debris thanks to the unique Electrolux Professional SpeedCare drum
- ▶ Save time and maximize productivity while working in optimal conditions



¹ Compared to domestic machines



6 into 1

myPRO can replace
up to 6 domestic washers
3 x longer lifetime. 2 x faster.



3 times longer lifetime*
and trouble-free
operation thanks to more
durable construction with
professional components



myPRO Laundry solutions with a Professional heart

How it works

- ▶ **Triple the lifetime* with 7.500 cycles**
 - More durable construction with professional components
- ▶ **Up to 50 % faster* processes¹**
 - Save time: Cotton 60 °C programs take only 82 minutes (starting with cold water at 15 °C)
 - Using the hot water inlet cuts cycle time by an extra 12 minutes
- ▶ **Increased flexibility and process performance¹**
 - Professional programs to meet every need, for top quality results
 - Higher hygiene and cleanliness with dedicated disinfection and special mop programs for microfibre mops and cloths
- ▶ **Trouble-free operation**
 - Easy plug-and-play installation with pump drain
 - Gravity drain valve model¹ for the most demanding applications²
 - Optional direct connection from condensed water tank to drain for instant discharge³
- ▶ **Less vibration and noise***
 - Highly effective shock absorbance system and optimally balanced components and panelling¹
 - Below 50 dB in the washing process

Your domestic washing machine not meeting your needs anymore?

Triple the lifetime of your machine with myPRO laundry solutions.

Based on tests made at Electrolux Professional laboratory.

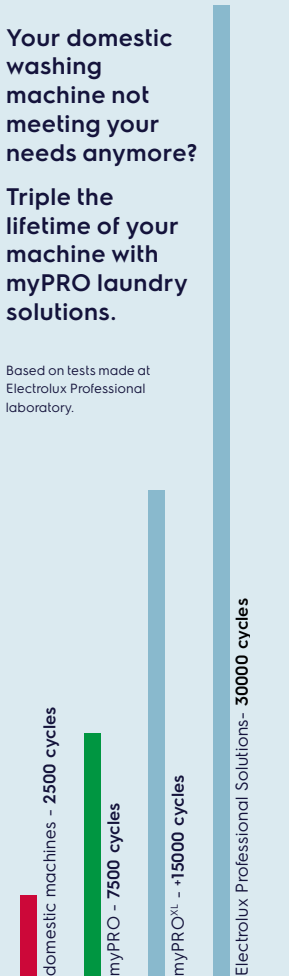

* Compared to domestic machines ¹ myPRO Washer ² Like Facility Management and Aged Care ³ myPRO Dryers



2 times faster wash cycles
and excellent laundry care
with the Electrolux Professional
SpeedCare drum

myPRO
by Electrolux
Professional

myPRO Washer with a Professional heart

How it works

Electrolux Professional SpeedCare drum

- ▶ Shortens wash cycle times
- ▶ Speeds up soaking process
 - Faster soaking reduces the mechanical action on dry garments
- ▶ Optimized drum perforation ensures removal of all dirt and particles for best laundry care and outstanding dewatering
 - Efficient flushing of solid particles out of the drum ensured by 4.5 mm large holes, minimizing textile abrasion by particles



What is the result when drum holes are, for example, only 2.2 mm in diameter (less than half the size compared to myPRO), and there are only half as many as needed?

- ▶ Low hygiene quality and increased risk of garment damage due to solid particles left in the drum
- ▶ Slower soaking can increase cycle times
- ▶ Less dewatering
 - higher moisture retention
 - higher energy costs in the drying process

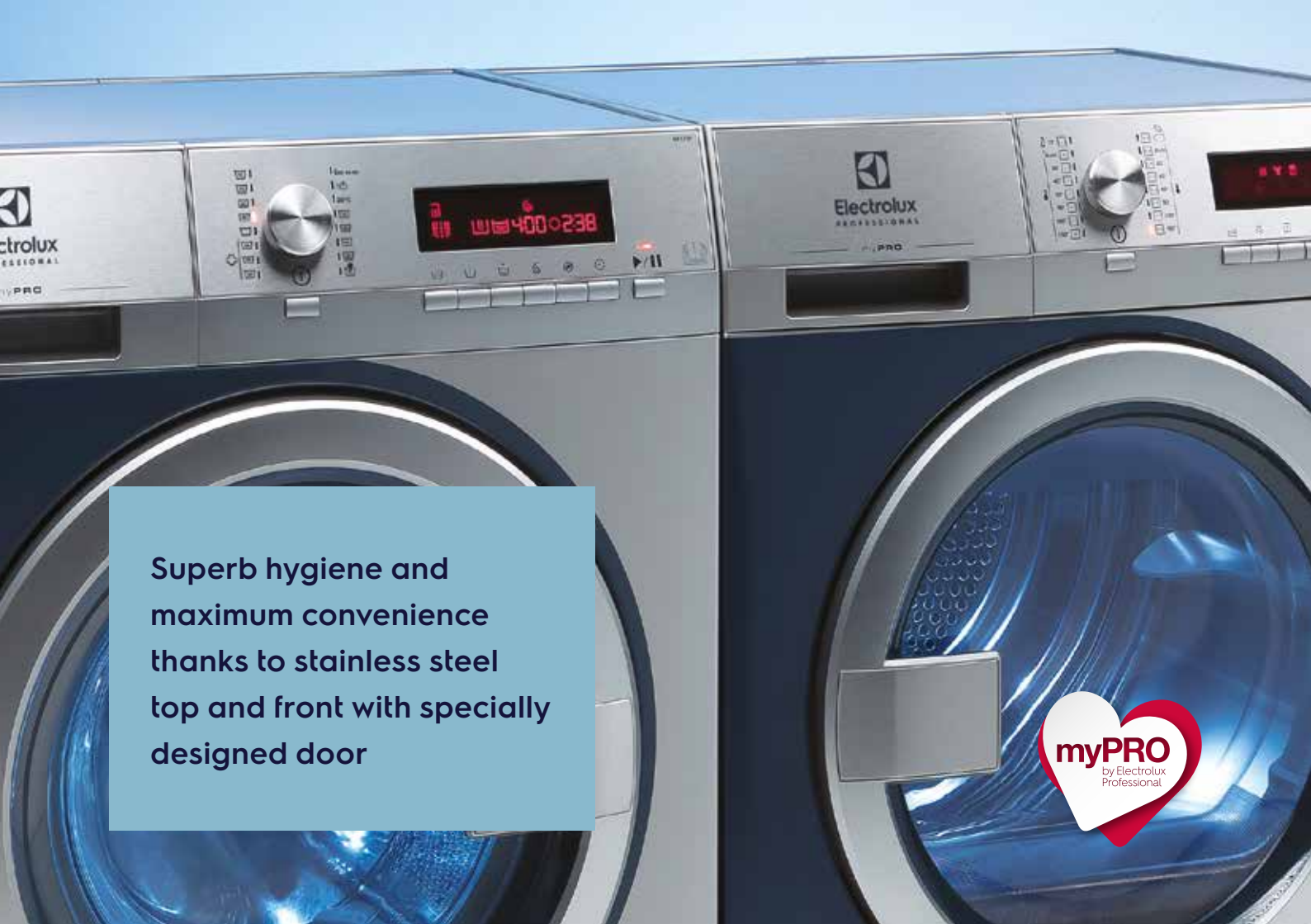

Superb hygiene and maximum convenience thanks to stainless steel top and front with specially designed door



myPRO Laundry solutions with a Professional face

How it works

- ▶ **Superb hygiene with corrosion-proof bicolour exterior**
 - Easy-to-clean stainless steel top and front
 - Stylish, classy and sturdy
- ▶ **Easy and ergonomic operation**
 - Easy loading and unloading with 465 mm large, robust pull-to-open door
- Inner drum lighting
- Robust knob for easy selection of program
- Start button directly under the knob
- Install the Washer and Dryer on the Pedestal for a more comfortable loading/unloading process
- ▶ **Peace of mind with child-safe door**
 - Easy to push open from inside
- ▶ **Space savings with stacked solution**
 - Stack the Dryer on the Washer to save maximum floor space





Major energy savings
and superb drying results
thanks to hot water inlet
and Automatic Moisture
Control

myPRO
by Electrolux
Professional

myPRO Laundry solutions with a Green soul

1

How it works

myPRO Washer

- ▶ **Money and energy savings**
The smart professional solution with guaranteed energy efficiency
- ▶ **Time savings due to hot water inlet**
Water does not need to be heated thereby reducing cycle time, costs and energy use
- ▶ **Great energy savings in drying with the Electrolux Professional SpeedCare drum**
Outstanding dewatering and lower moisture intensity due to optimal drum design and 1400 rpm spin (536 G)

myPRO Dryer

- ▶ **Money and energy savings***
The smart professional solution with the highest energy efficiency
- ▶ **Time, energy and money savings with Automatic Moisture Control technology – independent of load**
 - Lowest energy consumption due to instant stop at desired moisture level
 - Shortens the drying cycle
 - Prevents over-drying for longer lasting linen
 - More accurate than domestic machines



2

myPRO Washer with a Professional heart

How many kg of laundry do you wash every day?
How long does this take you or your employees?

Domestic machine (2,7 kg/h)

Daily wash load, kg	Cycle times, h/min	Energy consumption, kWh	Water consumption, l	Costs, €	Money savings, €	Time savings, h/min
8	3 h	1.02	56	0.39		
16	6 h	2.04	112	0.77		
24	9 h	3.06	168	1.16		
32	12 h	4.08	224	1.55		
40	15 h	5.10	280	1.93		
48	18 h	6.12	336	2.32		



Electrolux Professional myPRO smart professional Washer (6,9 kg/h)

8	1 h 10 min	0.70	65	0.31	0.07	1 h 50 min
16	2 h 20 min	1.40	130	0.63	0.15	3 h 40 min
24	3 h 30 min	2.10	195	0.94	0.22	5 h 30 min
32	4 h 40 min	2.80	260	1.25	0.29	7 h 20 min
40	5 h 50 min	3.50	325	1.57	0.37	9 h 10 min
48	7 h	4.20	390	1.88	0.44	11 h 00 min





myPRO Washer

WE170P

WE170V

Washing capacity, kg	8	8
Drum volume, l	67	67
Energy efficiency class	D	D
Spin speed, rpm (G-factor)	1400 (536)	1400 (536)
Washing/Spinning noise level, dB(A)	49/75	49/75
Frequency, V/Hz	230/50/60	230/50/60
Cabinet, top and front	Stainless steel	Stainless steel
Drum design	SpeedCare drum	SpeedCare drum
Water inlet	Hot & cold	Hot & cold
Draining system	Drain pump	Drain valve
Width/Depth/Height, mm	597/624/850	597/624/850
Weight (without packaging), kg	80.5	80.5

Consumption data Standard program: cotton 60 °C, full load

Total time, min./cycle (hot water inlet)	70	70
Water consumption (cold), l	65	65
Energy consumption, kWh	0.7	0.7



myPRO Dryer

TE1120

TE1120HP

Drying capacity, kg	8	8
Drum volume, l	120	120
Energy efficiency class	B	A++
Condensation efficiency	A (> 90%)	B (> 80%)
Drying technology	Condensation	Heat Pump
Declared drying noise, dB(A)	< 70	< 70
Total Power Watts	2600	900
Frequency, V/Hz	230/50/60	230/50
Width/Depth/Height, mm	596/625/850	596/640/850
Weight (without packaging), kg	44	49

Consumption data Standard program: 60% Initial Moisture

Total time, min./cycle	129	155
Energy consumption, kWh	4.88	1.99



myPRO Accessories

Pedestal

Stacking kit

Smart professional solutions. Facts and figures at a glance

2



The Professional heart for guest-operated laundry facilities: myPROzip



Leisure time is precious - ensure your guests get the most out of their trip with myPROzip

How it works

myPROzip Washer and Dryer

- ▶ **Perfect for small businesses such as**
 - Small Hotels and Bed & Breakfasts (guest use)
 - Out-of-home resident services
 - Camping, marinas, petrol stations, student houses
- ▶ **Simple to operate – easy to understand**
 - myPROzip Washer with 6 programs (no knobs) and quick-view icons that speak your guests' language
 - myPROzip Dryer with 2 temperature selections
 - quick & easy to operate for best drying results





myPROZip Washer with coin box solo



myPROZip Washer and Dryer with coin box duo

Enjoy myPROZip FlexiPay comfort

How it works

- ▶ **Chose your most convenient payment system type and take advantage of**
 - Electrolux Professional payment system
 - Individual payment system
 - Other available payment systems
- ▶ **Select the option that best fits your needs**
 - Coin box solo, coin box duo, stacked version or side-by-side

And for your guests: FlexiCycle comfort

- ▶ **Washer programs are easily selected using the 6 buttons**
- ▶ **Each wash program can be priced individually**
 - Guests make their choice and only pay for the real-time cycle
- ▶ **Dryer time can be extended, even during the drying cycle**
 - By simply buying more time (or inserting additional coins)



myPROzip Washer

WEI70PP

WEI70VP

Washing capacity, kg	8	8
Drum volume, l	67	67
Spin speed, rpm (G-factor)	1400 (536)	1400 (536)
Washing/Spinning noise level, dB(A)	49 / 75	49 / 75
Frequency, V / Hz	230 / 50 - 60	230 / 50 - 60
Cabinet, top and front	Stainless steel	Stainless steel
Drum design	SpeedCare drum	SpeedCare drum
Water inlet	Hot & cold	Hot & cold
Draining system	Drain pump	Drain valve
Width/Depth/Height, mm	597 / 624 / 850	597 / 624 / 850
Weight (without packaging), kg	80.5	80.5

Consumption data Standard program: cotton 60 °C, full load

Total time, min./cycle (hot water inlet)	70	70
Water consumption (cold), l	65	65
Energy consumption, kWh	0.7	0.7



Coin Meter



Coin Box Solo/Duo

myPROzip Payment connections

Model name	B11COINMTR	B11COINBOX / B12COINBOX
Width/Depth/Height, mm	208 / 280 / 116	140 / 340 / 840
Packaging Width/Depth/Height, mm	310 / 380 / 160	380 / 180 / 850
Weight (with packaging), kg	3.2 (4)	12.8 (13) / 15.8 (16)
Adjustable feet	-	4



myPROzip Dryer

TE1120P

Drying capacity, kg	8
Drum volume, l	120
Condensation efficiency	A (> 90%)
Drying technology	Condensation
Declared drying noise, dB(A)	< 70
Heating element, Volt/Watt	230 / 2600
Frequency, V / Hz	230 / 50 - 60
Width/Depth/Height, mm	596 / 625 / 850
Weight (without packaging), kg	44

Consumption data Standard program: cotton 60 °C, full load

Total time, min./cycle	129
Energy consumption, kWh	4.88



Pedestal



Stacking kit



Harness

myPROzip Accessories

► Find out more about myPRO accessories here

<http://mypro.electrolux.com/myprozip-guest-operated-laundry/>

3

**Bigger business?
More choice for a bigger
load with myPRO^{XL}**

Electrolux
PROFESSIONAL



myPRO^{XL}. Top durability and performance in a 12kg solution

How it works

- ▶ **More than 15.000 cycles**
 - Even more robust with heavy duty SKF bearings, cast iron housing and triple seals
 - More durable thanks to 8-point spring suspension and premium steel counterweights
- ▶ **Save time! Faster and more efficient.**
 - myPRO^{XL} Washers: default 35min for cold water program. Just 73 min for normal 60 °C program with 15 °C cold and 55 °C hot water inlet temperatures
 - myPRO^{XL} Dryers: only 87 minutes per full load, 45 minutes per half load
 - myPRO^{XL} Gas Dryers: only 84 minutes per full load, 44 minutes per half load
- ▶ **Increased flexibility**
 - Top quality results with professional programs designed to meet every need
- Improved hygiene and cleanliness thanks to dedicated disinfection programs
- Time of day promotional pricing (for coin machines)
- Water saving thanks to adjustable water levels
- ▶ **Trouble-free operation**
 - Soft-mounted installation design with pump drain*
 - Easy buttons for program and option selection
 - Added convenience as a result of it being front serviceable
- ▶ **Less vibration and noise**
 - Highly effective shock absorbance system and optimally balanced components and panelling
 - Below 62 dB in the washing process

*The dryer should be vented with air-duct installed

myPRO not big enough anymore?
For peace of mind choose myPRO^{XL}: bigger load, robustly built to last, over 15.000 cycles guaranteed.

Based on tests made at Electrolux Professional laboratory.

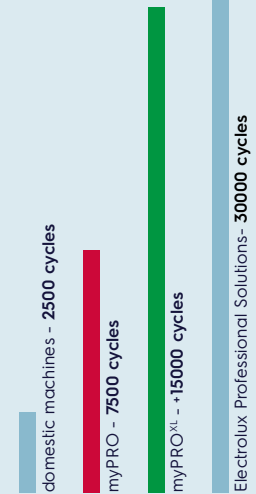

Whatever solution you choose, we guarantee you maximum durability

Choose the option that meets your needs:

Side by side solution



Washer

Dryer

Stacked solution



Washer + Dryer

Dryer + Dryer

Payment options
available for
all models

for **single** appliances:



for **stacked** appliances:





myPRO^{XL} Washers

WE1100P

Washing capacity, kg	12
Drum volume, l	100
Energy efficiency index, %	>52
Spin speed, rpm (G-factor)	1050 (300)
Washing/ Spinning noise level, dB(A)	62/72
Frequency, V/Hz/A	220-240/50Hz/10
Cabinet, top and front	Powder painted
Drum design	Stainless steel
Water inlet	Cold+Hot
Draining system	Drain Pump
Width/ Depth/ Height, mm	686x1098x765
Weight (without packaging), kg	136

Consumption data**

Standard program: cotton 60 °C, full load

Total time, min./cycle	73
Water consumption (cold+hot), l	87
Energy consumption, kWh	1.01

**Water temperature 15 °C cold water and 55 °C hot water

myPRO^{XL} Payment accessories

	Coinmeter&boxes		Stacking kits	
	Standalone installation	Stacked installation	Washer&Dryer	Dryer&Dryer
Model name	A11COINMTR	A11COINMTR	STACXL	STACXL
Packaging Width/ Depth/ Height, mm	380x310x160	380x310x160	774x890x275	774x890x275
Weight (with packaging), kg	2	2.5	11.4	14



TE1220E



TE1220G

myPRO^{XL} Dryers

Heating type	Electric	Gas
Drying capacity, kg	12	12
Drum volume, l	218	218
Drying technology	Vented	Vented
Declared drying noise, dB(A)	68	68
Total Power Watts	4830	6300 (21,000 BTUs)
Frequency, V/Hz/A	220-240/50Hz/22	220-240/50Hz/10
Width/ Depth/ Height, mm	686x1098x822	686x1098x822
Weight (without packaging), kg	87	78
Total time, min./cycle	87	84
High temperature program, full load		

4

Maximum productivity
while ironing in comfort
thanks to special programs
and ergonomic design



myPRO Steam Ironer with a Professional heart

How it works

- ▶ **High quality construction**
 - Durable construction with professional grade stainless steel work top
- ▶ **Faster and easier processes***
 - Save time compared to hand ironing
 - Use steam during ironing, to remove wrinkles in less time
- ▶ **Increased flexibility and process performance**
 - 5 temperature settings for perfect results with every type of fabric
 - Full control of roller speed, thanks to flexible foot pedal
- 3 steam settings: low, medium and high (with option to have continuous or on demand generation of steam)
- Long lasting steam production thanks to the high capacity water tank (1.9l)
- Compact¹ thanks to foldable top
- Easy to move freely from room to room
- ▶ **Trouble-free operation**
 - Plug-and-play installation
 - Easy to fill water tank, which can be filled on the go²



* Compared to domestic machines

¹ 85cm model

² Remove plug for safety

Be smart! Save time working in optimal conditions

Choose the model that meets your needs

IS185. Perfect even for the most compact laundries



- ▶ Productive with **85 cm roller**
- ▶ When folded, takes up similar space of a standard chair
- ▶ Mobile for great flexibility

IS1103. Maximum productivity in smart professional laundries

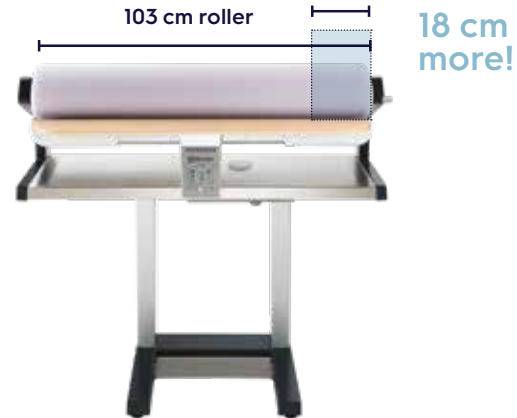

- ▶ Highest productivity with **103 cm roller**
- ▶ Fixed frame and always ready for full time operations
- ▶ Mobile for great flexibility



Smart professional solutions

Facts and figures at a glance



IS185



IS1103

myPRO Steam Ironer

Roller length	85 cm	103 cm
Roller diameter	16 cm	16 cm
Adjustable ironing speed (rpm)	2.40 - 6.80	2.40 - 6.80
Water reservoir capacity - nominal	1.9 l	1.9 l
Water reservoir capacity - actual	1.4 l	1.4 l
Steam level - I / II / III	0.9/1.1/1.3 l/hour	0.9/1.1/1.3 l/hour
Excess Temperature fuse (steam/chest)	216/260 °C	216/260 °C
Nominal Voltage	230 V / 50 Hz	230 V / 50 Hz
Total Power Watts	3300	3300
Fuse	16 A	16 A
Working - Width / Depth / Height, mm	940 / 400 / 1050	1120 / 400 / 1050
Folded - Width / Depth / Height, mm	520 / 400 / 1000	1120 / 400 / 1050
Weight (without packaging), kg	39	50



myPRO Accessories



Roll padding



Roll cover



Lime descaling cartridge

myPRO Family

The smart professional laundry solution for small businesses





Are your needs not being met? Visit us at www.electroluxprofessional.com and discover our professional Laundry solutions (more than 30,000 cycles guaranteed!)





Experience the Excellence
electroluxprofessional.com

Follow us on



Electrolux Professional is the global expert in laundry and textile cleaning, with over 100 years of experience. Our solutions deliver outstanding durability, flexibility and cost-effectiveness to customers all over the world. All based on customer insight and close collaboration with industry experts.

Discover more about myPRO
the Smart Professional Laundry solution
www.electroluxprofessional.com

