

Operating handbook

Flatwork ironers IC43316 – IC43320

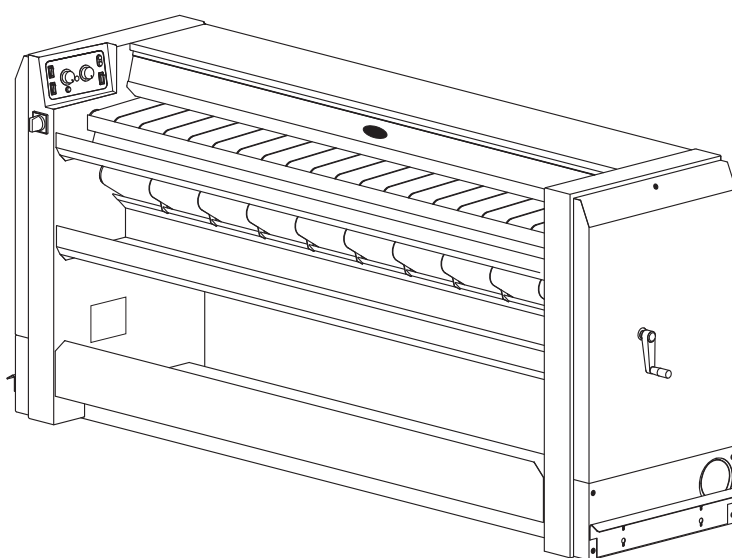

Translated from french



01103030/GB
08.18

01103030	1004	0	0
Notice	Date	Page	

Pages/Chapters

General operating	
Precaution for use	1/1
General	
Identification plate.....	2/2
Method of use	
Standard control console	1/3
Starting machine with standard console.....	2/3
Stopping machine with standard console	3/3
DIAMMS control console	4/3
Simplified instructions for using the ironer.....	5/3
Starting machine with DIAMMS console	7/3
Cooling mode	8/3
Automatic mode.....	8/3
Manual mode.....	9/3
Service screen in automatic mode	10/3
Service screen in manual mode	10/3
Stopping machine with DIAMMS console.....	11/3
Additional instructions.....	12/3
Precautions for use.....	14/3
Using the handle.....	16/3
Safety	
Locking and tagging procedure	3/4
Safety devices	4/4
Operating incidents	
The linen remains stuck to the cylinder	1/5
When the linen comes off the dryer-ironer it is not dry	1/5
The heating does not work or works badly	2/5
The machine temperature drops	3/5
The machine stops suddenly.....	3/5
Additional instructions.....	4/5
Maintenance	
Preventive maintenance	1/6
Replacing ironing bands	5/6
Appendices	
Explanation of graphic symbols.....	1/7
Explanation of washing symbols	2/7
Conversion of measurement units.....	3/7
Lubrification table	4/7

01103030	1004	1	1
Notice	Date	Page	

1. General operating

OPERATING HANDBOOK

Precaution for use

- The machine should not be used by children.
- This ironer must be used exclusively for textiles appropriate for machine ironing, which have been previously and exclusively washed in water.
- Blankets should not be ironed.
- Be careful with synthetic linen and also with printed linen. They can melt and stick on the cylinder.
- Do not iron articles that contain plastic, foam, sponge rubber or similarly textured rubber-like materials.
- Do not iron linens coated with solvent, paint, wax, grease or any easily inflammable products.

01103030	1004	1	2
Notice	Date	Page	

In the machine you should have found a set of instructions and a servicing poster to display in your laundry.

You must have found with this handbook, a crank for the manual drive of the cylinder.

Depending on its destination, the dryer ironer is delivered bare or may be placed on a transport pallet and/or packed with plastic film.

In some cases, it may be delivered in maritime packing (wood crate).

Please refer to the handling chapter in this instruction handbook for a description of handling operations.

Before any use, it is compulsory to read the instruction handbook.

Users must have learnt how to the machine operates.

The identification plate is situated on the left side.

**This machine should be installed in conformance to the health and safety regulations, and only used in a sufficiently aerated area.
Check the instructions before installing or using the machine.**

01103030	0806	2	2
Notice	Date	Page	

2. General

OPERATING HANDBOOK

The machines described in this handbook have an ironing capacity of 1.650 m (65") or 2.065 m (81¹/₃") wide according to their type.

The ironing speed can be adjusted according to the linen texture and its degree of moisture.

The temperature of the ironing cylinder can also be adjusted by a thermostat.

The parameters are displayed by a control panel.

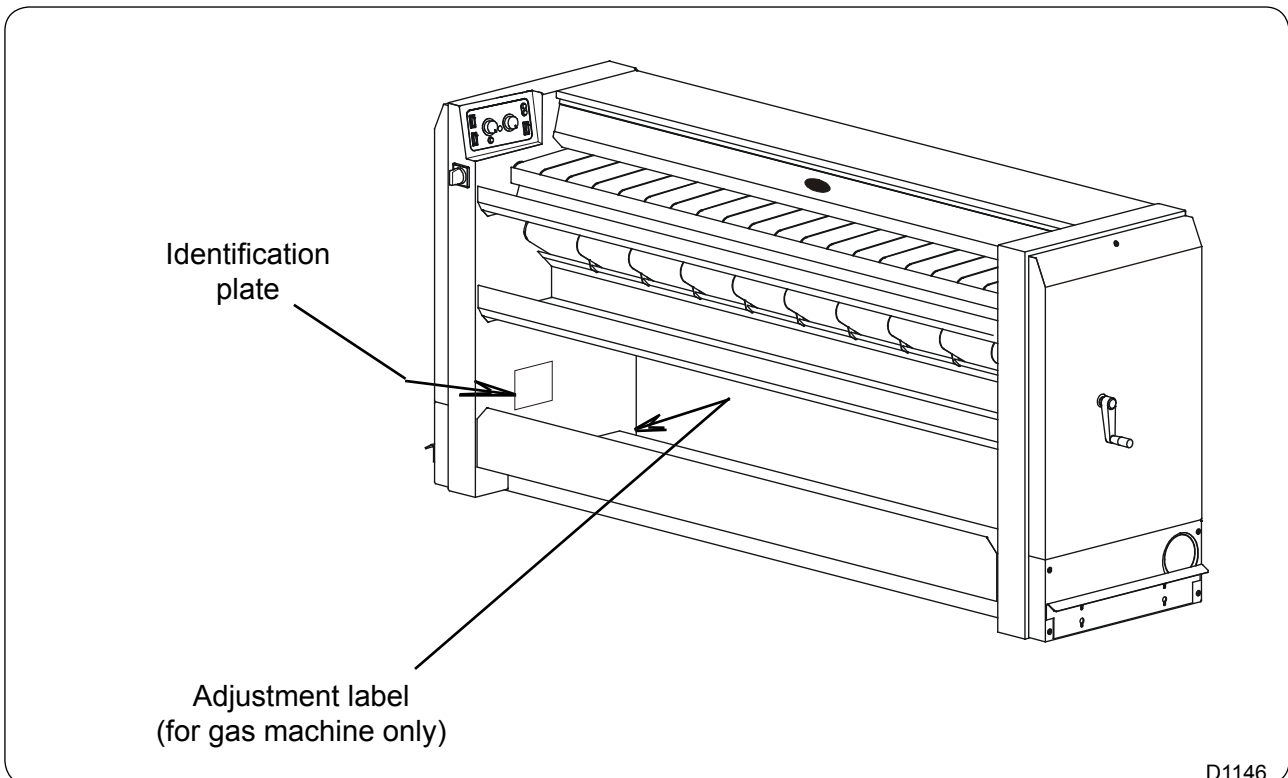

D1146

Identification plate

For safety reasons use only original spare parts.	
TYPE : _____	 Qn (HI) : ____ kW G ____ mbar Mn/Vn : ____ / ____ Type : _____
SERIAL N° : _____	
QC N° : _____	G20 - ____ mbar G25 - ____ mbar G30 - ____ mbar G31 - ____ mbar η : _____ P. max. : ____ kPa
PROD. N° : _____	
CAPACITY : ____ l ; ____ kg	 IP 4 Date : ____ / ____ / ____ ELECTROLUX LAUNDRY SYSTEMS FRANCE 10430 Rosières-près-Troyes FRANCE Made in FRANCE
P. MAX. : ____ W	
(M) ____ kW ISOL. CLAS : _____	
____ W	
____ V ~ ____ Hz	
____ A	
32101842	

01103030	1004	3	2
Notice	Date	Page	

This page is left blank on purpose.

01103030	0305	1	3
Notice	Date	Page	

Standard control consol

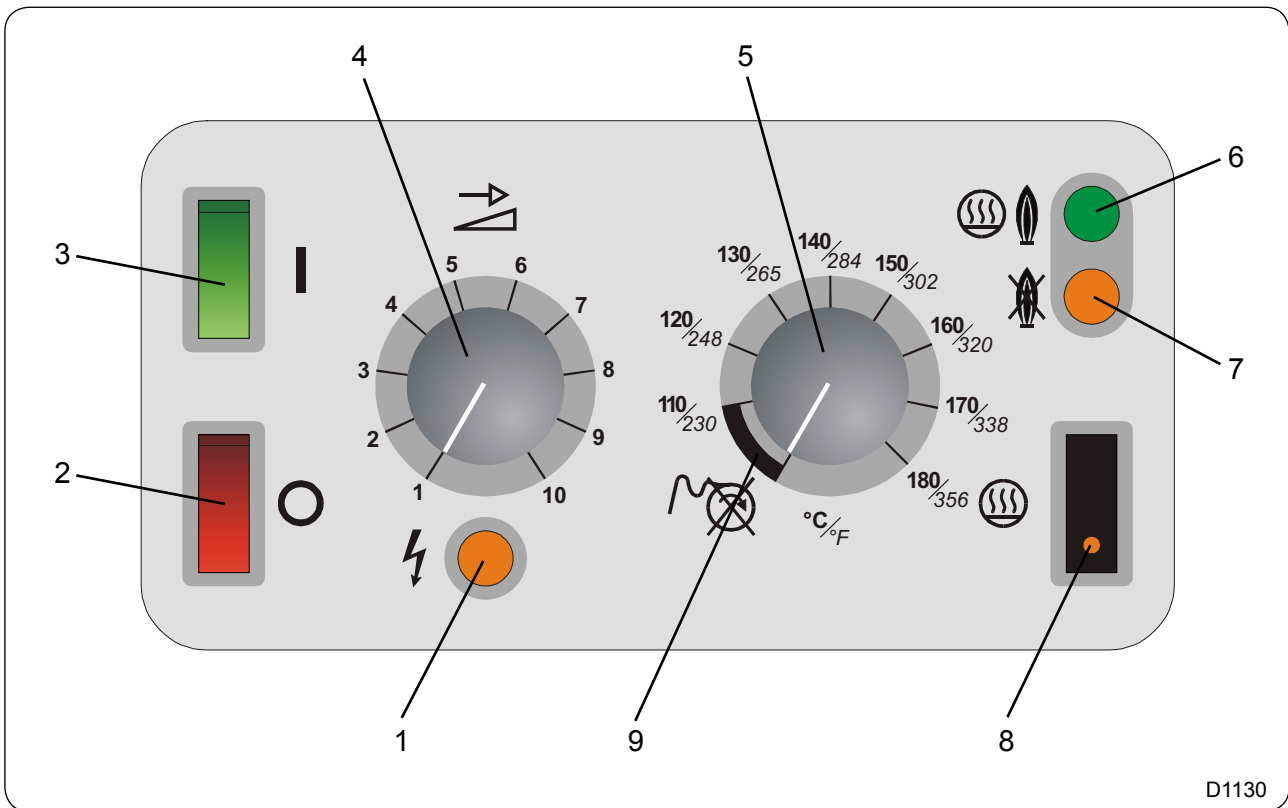

D1130

1. **"Voltage"** indicator
2. **"Stop"** switch
3. **"On"** switch
4. **"Ironing speed adjustment"** potentiometer
5. **"Ironing temperature selection"** thermostat
6. **"Heating"** indicator on
7. Gas heating **"Ignitor failure"** indicator
8. **"On / Off"** heating switch with **"On"** indicator
9. **"Automatic stop"** zone

01103030	1004	2	3
Notice	Date	Page	

Starting machine with standard console

- Turn main section switch to I (ON), the indicator (1) "**voltage**" lights".
- Turn the potentiometer (4) to the minimum speed.
- Adjust thermostat (5) on required temperature. Usual ironing temperature is around 180 °C (355 °F) for cotton.
- Press button (3) "**On**".

The cylinder and the guiding bands rotate.

The fan works and draws the air out of the machine to outside the building.

- Press switch (8) "**heating on**", the key indicator lights. The heating indicator (6) lights. The temperature rise is reached after approximately 12 min for a temperature of 180 °C (355 °F). The heating indicator (6) switches off as soon as the required ironing temperature is reached.
- Check that the finger protection is working. The finger protection must stop the machine when it is touched.
Press button (3) "**On**" to restart the machine.
- Adjust potentiometer (4) on an average speed and start ironing.
- Adjust the ironing speed depending on the textile processed and the moisture rate of the linen.
- If the pipe burner is secured, the indicator (6) switches off and the indicator (7) lights ; (to restart the machine, press "STOP HEATING" and then "HEATING ON" (8).

01103030	1004	3	3
Notice	Date	Page	

Stopping machine with standard console

- In order to extend the lifetime of your machine and its components, observe the following instructions to stop the heating.
- Press switch (6) "**Heating stop**", its indicator switches off. The "**Heating**" indicator (8) switches off too.
- Set the temperature setting button to minimum.
- Continue to feed in damp laundry until the temperature of the cylinder no longer produces satisfactory drying.
- The machine stops automatically when the temperature falls sufficiently low.
- Turn the general switch situated on the left casing to O (off).

CAREFUL : At any time, it is possible to stop the machine by pressing key (2) "**General stop**", a high temperature of the ironing cylinder may damage the ironing strips.

01103030	1004	4	3
Notice	Date	Page	

DIAMMS controle console

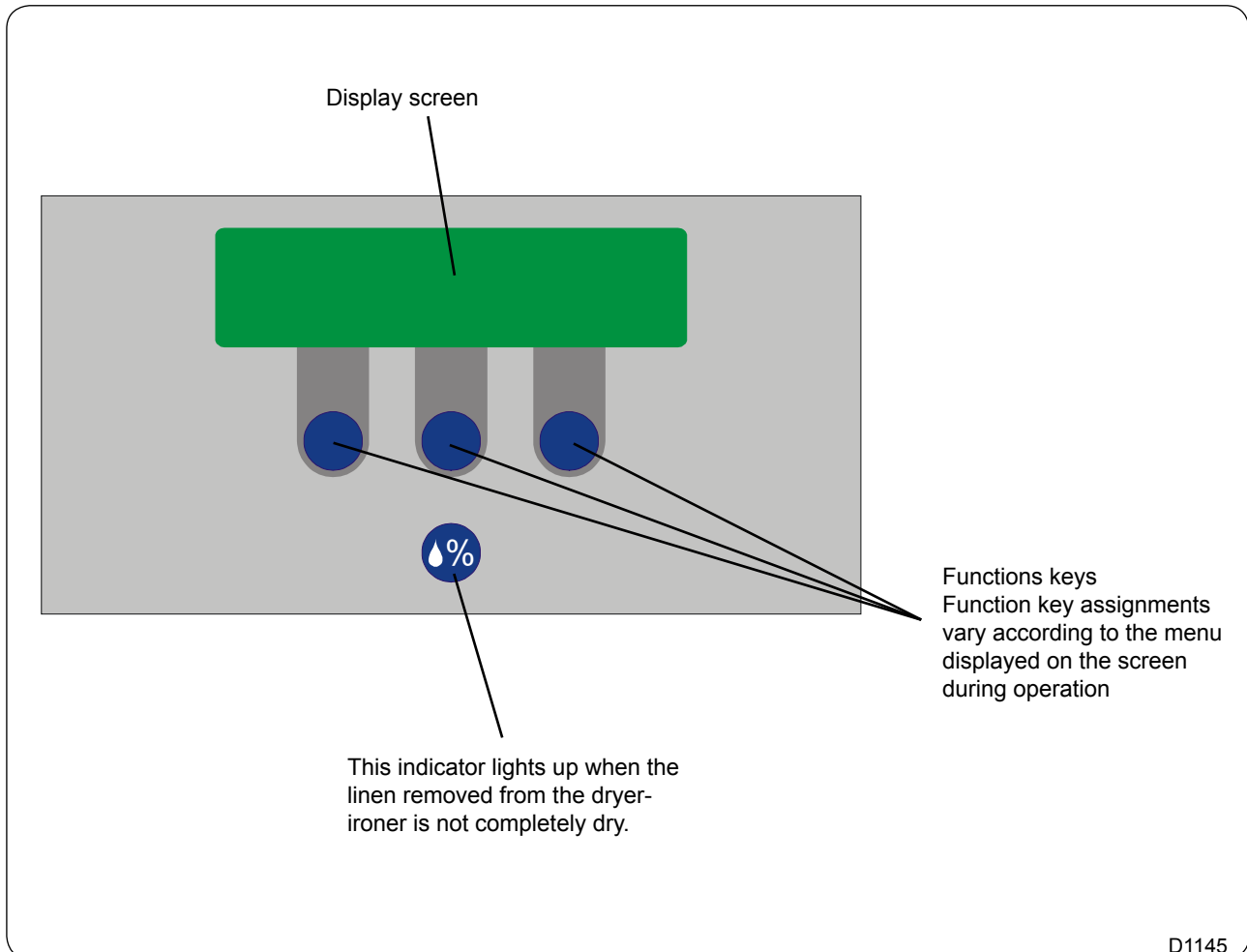



01103030	1004	5	3
Notice	Date	Page	

3. Method of use

OPERATING HANDBOOK

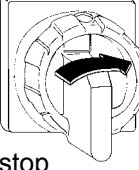
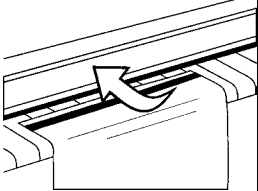
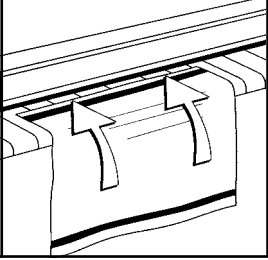
Simplified instructions for using the ironer

<h1>1</h1>	<p>Switch on the main switch, open the gas stop valve or the steam valve.</p> 	<p>Wait for displaying of the following message and press the central key.</p> <div style="background-color: #008000; color: white; padding: 5px; text-align: center;"> Stand by START </div>	<p>When it begins operating, the machine is set to «automatic mode». You can now insert sheets.</p> <div style="background-color: #008000; color: white; padding: 5px; text-align: center;"> Dx °C 2.5m/mn 000 MANU STOP </div>
<h1>2</h1>	<p>Manual Mode : Adjust the order temperature on the wished value thanks to keys (-) or (+) and push on OK.</p> <div style="background-color: #008000; color: white; padding: 5px; text-align: center;"> Set Temp : 180°C - + OK </div>	<p>Manual Mode : Adjust the ironing speed on the wished value thanks to keys (-) and (+) and push on OK.</p> <div style="background-color: #008000; color: white; padding: 5px; text-align: center;"> Set Speed : 2.0 m/mn - + OK </div>	
<h1>3</h1>	<p>Safety : The machine must stop when the mobile safety protector (hand safety) is switched on. Check operation of this protection every day.</p> 	<p>Ironing : Place the washing to be ironed on the feeding table.</p> <div style="background-color: #008000; color: white; padding: 5px; text-align: center;"> Error Gas Ignition </div>	
<h1>4</h1>	<p>Ignition fault on gas heating machine : This message keeps on flashing over 30 seconds if a fault occurs when igniting the gas burner.</p>		
<h1>5</h1>	<p>Stopping the machine : Push on any key to display "Select Running Mode" and push on STOP. Do not use the folding function during the cooling phase. Leave the machine cool down until the following message has disappeared. In an emergency, pressing the hand safety bar will stop the machine.</p> <div style="background-color: #008000; color: white; padding: 5px; text-align: center;"> Cool-Down : xx°C START </div>	<p>Switch the main switch off, close the gas stop valve or the steam valve.</p> 	

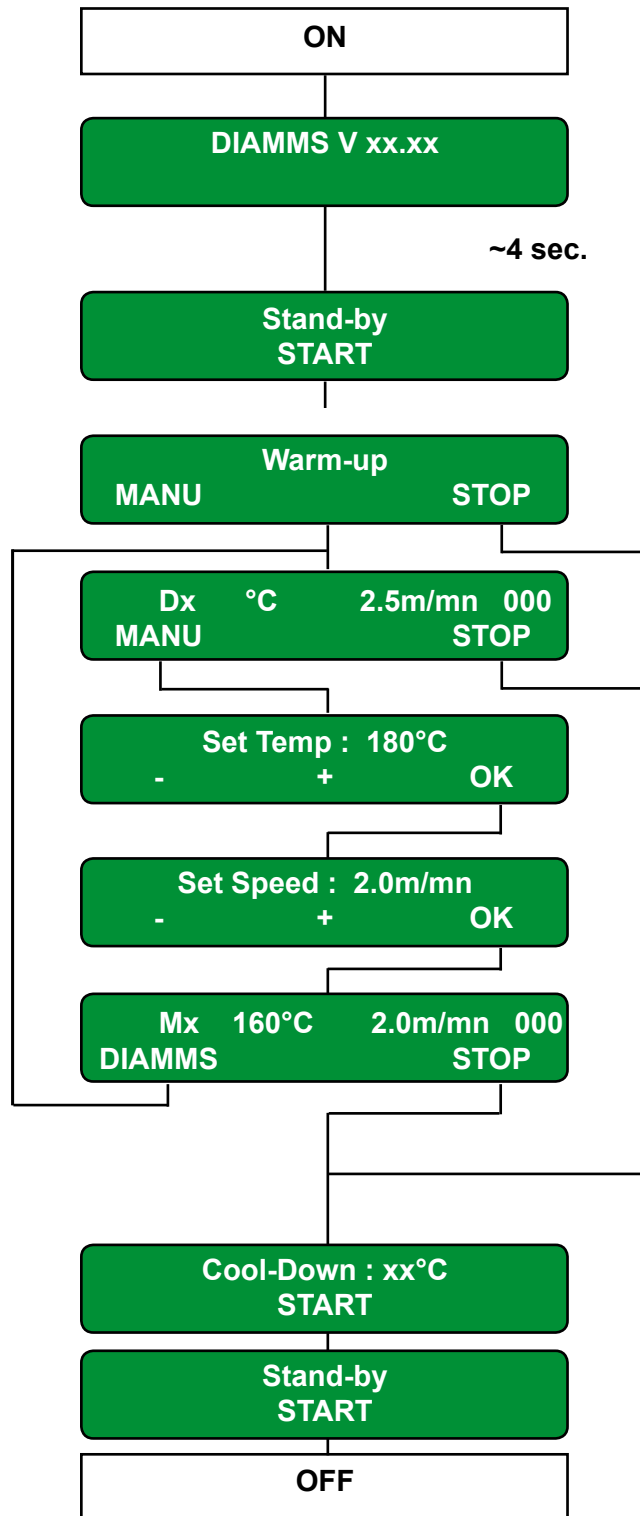

01103030	1004	7	3
Notice	Date	Page	

Starting the machine with DIAMMS console

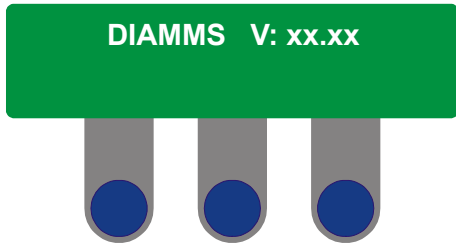

Start-up screen

Turn on the power to the machine using the machine's main switch. The software version will appear on the screen for 4 seconds.



"Emergency stop" warning message

If the screen displays this message, check whether the emergency stop button has been operated.



Reset the emergency stop button and confirm by pressing the central key.

In all cases, you will return to the previous menu.

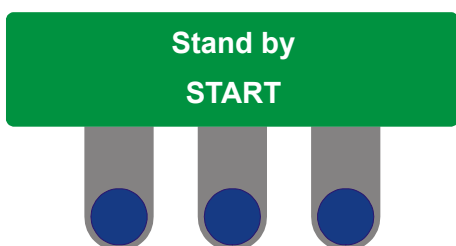

Accessing the start-up menu

The machine now asks you to press the central key to exit standby mode so as to display the pull-down menus and select the machine's operating modes.

01103030	1004	8	3
Notice	Date	Page	

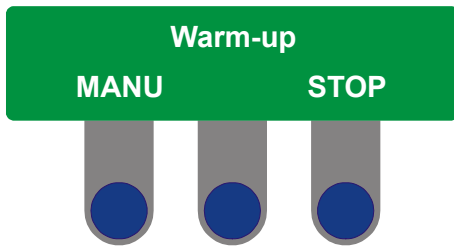

Warm-up

As soon as the machine is turned on, the «Start heating» command is given. The cylinder temperature begins to rise.

By default, the machine is set for automatic mode.

The service screen appears as soon as the sheets have been inserted or when the required temperature is reached.

Cooling mode

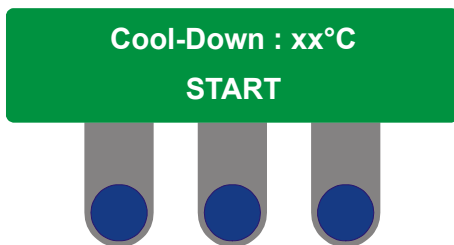

Cooling mode

When the **STOP** function is requested during operation, the machine will switch to standby and the heating system will be switched off.

The screen will remain in this mode as long as the temperature of the cylinder remains above 100°C (212°F).

The screen then displays the following message.

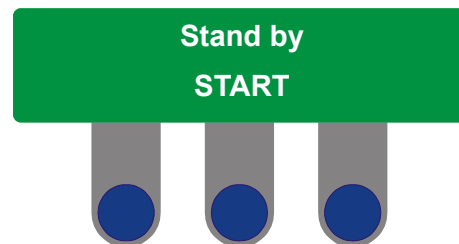

You can now switch off the machine.

Automatic mode

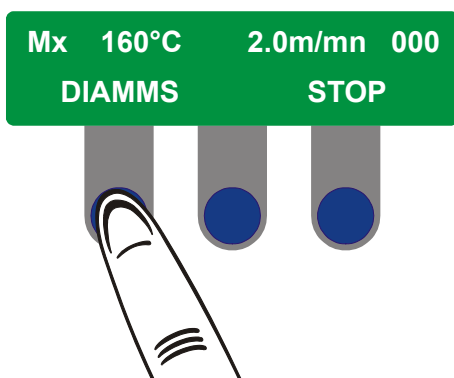

Selection of the automatic mode

When it starts up, the machine is set for automatic mode by default. However, you can switch over to manual mode at any time.

The «M» in the upper left-hand corner shows that you are in manual mode. To return to automatic mode, all you need to do is to press once on the «DIAMMS» button.

Each changeover from manual mode to automatic mode automatically resets the sheet counter.

01103030	1004	9	3
Notice	Date	Page	

3. Method of use

OPERATING HANDBOOK

Manual mode

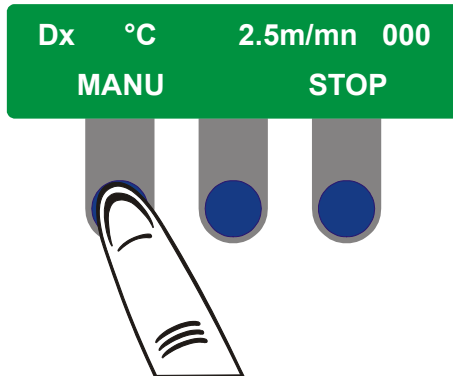

Selection of Manual mode

If you press **MANU**, you will switch to manual mode. In this mode you use the following menus to select the temperature and the ironing speed you wish to apply to the machine.

Each changeover from manual mode to automatic mode automatically resets the sheet counter.

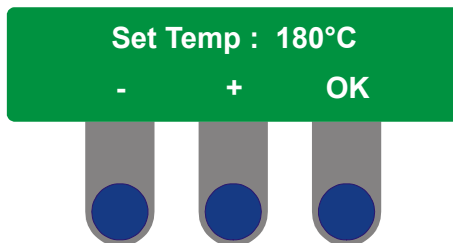

Temperature setting

The screen will now ask you to set the ironing temperature.

The ironing temperature can be adjusted in increments of 5 degrees Celsius (or 9 degrees Fahrenheit) by pressing.

Press **OK** to confirm the temperature.

Note: if you request a temperature lower than 120°C (248°F), the screen will display a (-) sign to indicate that the heating has been switched off and allow the machine to operate without heating.

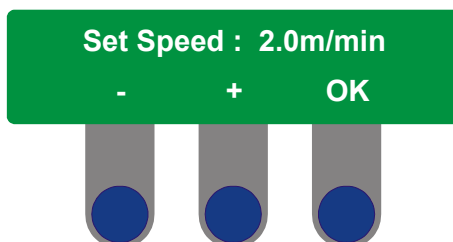

Ironing speed

The screen now asks you to select the ironing speed.

The ironing speed can be set between a minimum and a maximum value specified in the Settings menu. The value can be adjusted in increments of 1/10 of a metre (or 3/10 of an inch) by pressing.

Press **OK** to confirm the ironing speed.

It should be noted that the minimum and maximum ironing values depend on the converter adjustment settings.

01103030	1004	10	3
Notice	Date	Page	

Service screen in automatic mode

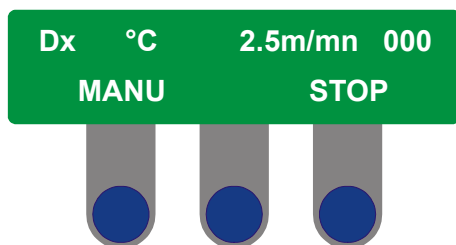

Service screen in automatic mode

The values for the current use of the machine are shown on the first line of the screen.

- The «D» shows that you are in automatic mode (DIAMMS).

The two following values show:

- The ironing speed
- The sheet counter information

In automatic mode (**DIAMMS**), the cylinder temperature will not be displayed. This is managed by the machine itself. Only the flashing «°C» indicator is shown.

The second line displays the commands accessible from the buttons on the panel.

Service screen in manual mode

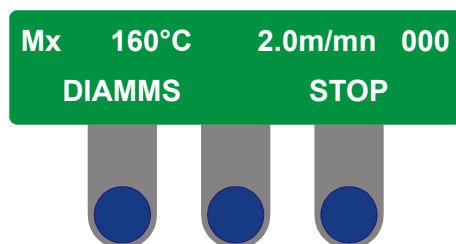

Service screen in Manual mode

The first line of the screen displays the values for the current use of the machine.

- The «M» shows that you are in manual mode.

The following three values show:

- The current cylinder temperature
- The ironing speed
- The sheet counter information

Various indications regarding the temperature of the ironing cylinder are displayed:

- A flashing "T" indicates that the machine is in the process of heating.
- A (-) sign after the "T" indicates that the temperature of the cylinder is below 100°C (212°F).
- The current temperature is displayed when the temperature of the cylinder is between 101°C and 245°C (213°F and 470°F).
Note : values 101-245°C are minimum and maximum temperature that the electronic programmer can display. The maximum ironing temperature cannot reach 245°C (470°F), a safety thermostat automatically cuts off heating before reaching this value.
- A (+) sign after the "T" indicates that the temperature of the cylinder is above 245°C (470°F).

The second-line displays the commands accessible from the buttons on the panel.

01103030	0411	11	3
Notice	Date	Page	

Stopping the machine with DIAMMS console

Please respect the following instructions when switching off the heating, to ensure that your machine and its components last for a long time.

- Use the **STOP** function on control panel to stop the machine.
- When the screen displays "**Stand by/Start**", switch the main switch to the "OFF" position.
- Close the gas inlet valve.

You can switch the machine off at any time by pressing on the machine stop switch; but note that if the ironing cylinder is too hot (above 120 °C (248 °F), it can damage the bands.

01103030	1004	12	3
Notice	Date	Page	

Complementary instructions for starting up a machine with gas heating

The ignition of the burner is delayed by 30 seconds following the start command in order to allow for the pre-ventilation of the combustion chamber.

The machine will be ready for use after the message has disappeared :
"Error Gas Ignition".

The noise at the inter-ignition is not an explosion. It is a normal phenomenon.

Complementary instructions for starting up a machine with electrical heating

The typical ironing temperature is 150 to 180 °C (300 °F to 356 °F). You just have to set the electronic thermostat to the required temperature.

In automatic mode, the ironing temperature is defined and managed by the machine.

01103030	1004	13	3
Notice	Date	Page	

3. Method of use

OPERATING HANDBOOK

Additional instructions to optimise a dryer-ironer.

When ironing small sheets or small washing, pass abreast the washing of the heating cylinder to provide correct regulation of the cylinder temperature.

As a general rule, the whole of the cylinder should be used (1). Either iron the linen from the front (2) or iron alternately (3), which makes maximum use of the heat units available over the surface of the cylinder. It also overcomes difficulties arising from random control values caused by partial use of the cylinder.

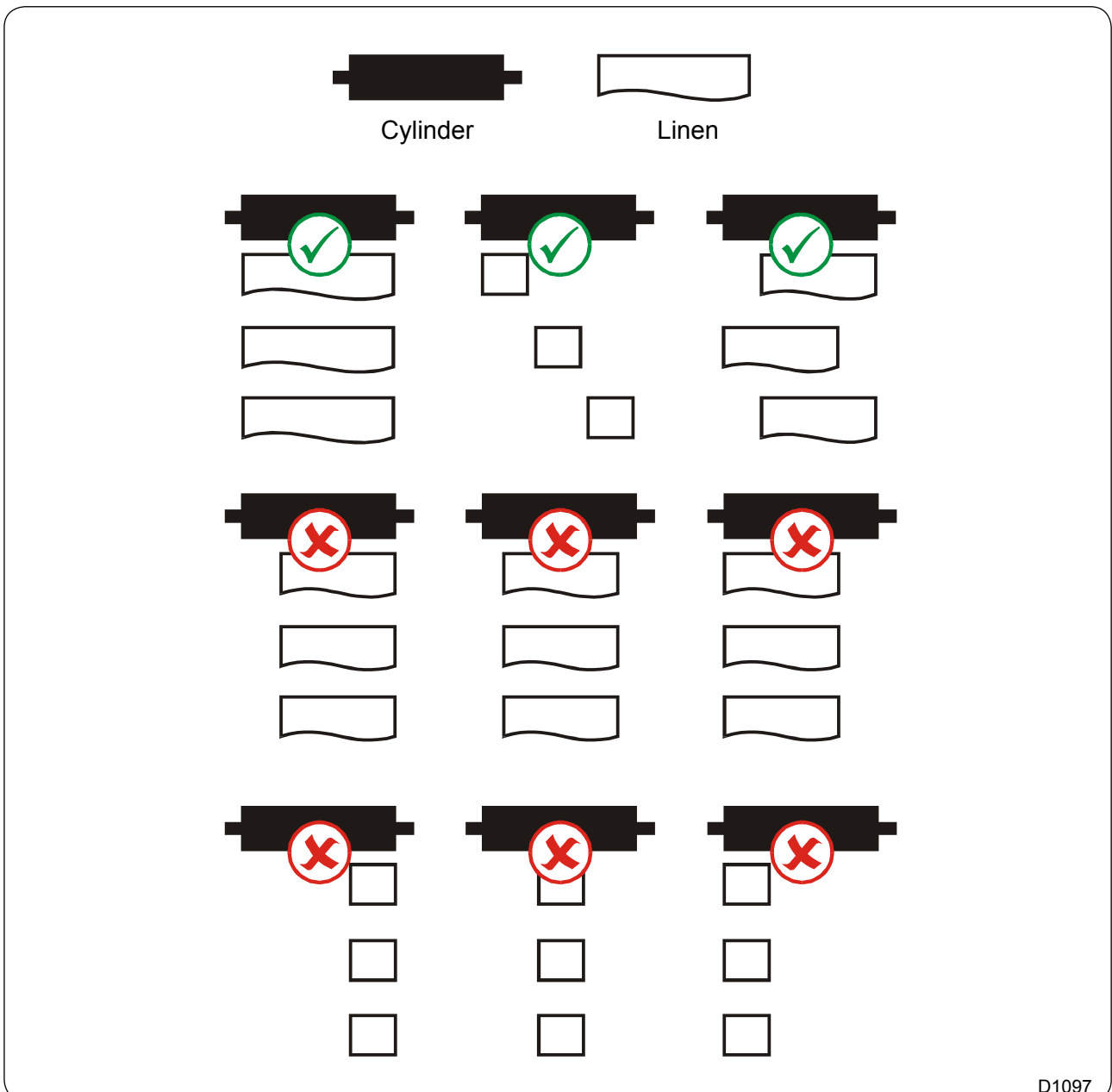

01103030	1004	14	3
Notice	Date	Page	

Precautions for use

Please respect the following usage recommendations to get the best out of your ironer:

In manual mode

- Avoid when running, too low or badadjusted temperatures as consequence of :
 - a too high ironing speed with high moisture content in sheets : bad sliding on metallic sparts.
 - a partial use of the ironing length of the cylinder : creating overheating (be careful especially, to the risk for the polycotton sheets to loose their shape, generally stabilised at 200 °C (392 °F)).
- You should begin ironing when the «**Warming up**» message disappears.
- Check that the washing can be ironed and check the temperature at which it is to be ironed.

The productivity and quality of ironing depend on the washing quality ; make sure that all these conditions are satisfied.

- We recommend as far as possible, that you should feed pieces of flat washing (towels, sheets, etc.) by their hem, with the seam facing top, to obtain maximum ironing quality.
- Carefully engage the washing to be ironed, because it is impossible to disengage a badly engaged washing.
- Do not iron washing folded in four, because it will be too thick to achieve the drying/ironing/folding quality that you are entitled to expect from your machine.
- If possible, use the entire ironing width of the dryer ironer.

01103030	1004	15	3
Notice	Date	Page	

3. Method of use

OPERATING HANDBOOK

Practices to avoid

- Make sure that the width of the washing does not exceed the useful width of the machine.
- Sizes not fitting the cylinder working length, partial use of the cylinder.
- Blankets should not be ironed.

Practices not recommended

- Worn polycotton sheets (cotton worn away) : uneven finish look when folded, high static electricity.
- Large cotton or flax-made sheets > 200 g/m².

Cautions

- Prepare the large sheets before feeding.
- Avoid the torn, worn or holed sheets, that may hook and alter the measurements and the longitudinal folding.
- Comply with the mini-maxi sizes of sheets.

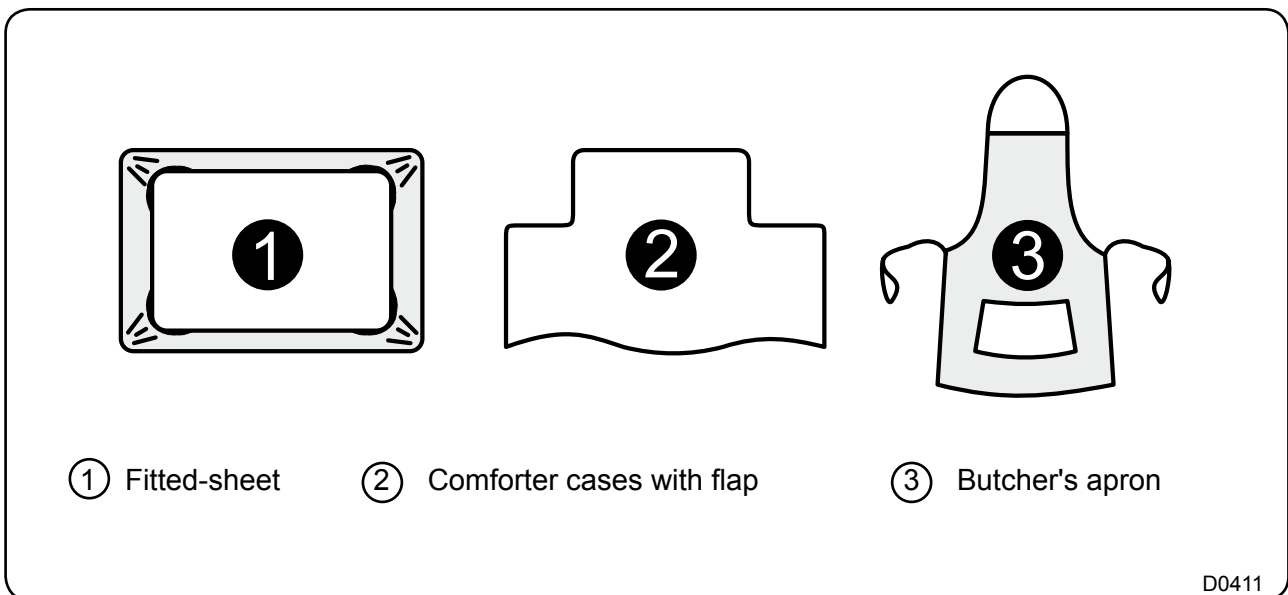

	Draw-sheets	Fitted-sheets	Comforter cases	Butcher's apron	Linen < 200 g/m ²	Linen > 200 g/m ²
Flatwork ironer	✔	✔	✔	○	✔	○

✔ Yes ○ Cautions

✘ Practices to avoid

01103030	0305	16	3
Notice	Date	Page	

Using the handle

The dryer ironer is fitted with a handle.

This is very useful to take out the washing if there is a power failure while you are ironing; or you can use it to feed a piece of wet washing to protect the ironing bands when the ironing temperature is too high.

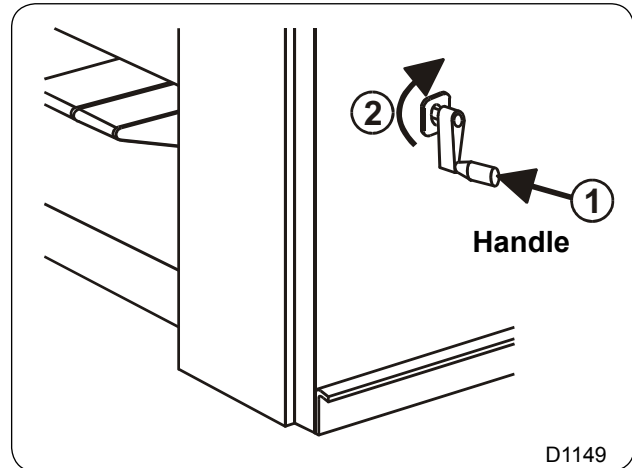

Using the tipping feed bin

The dryer-ironer is equipped with a tipping feed bin. This is very useful for letting large items hang to assist feeding and allow smoothing of linen by hand.

For ease of opening, lift the bin slightly before pivoting.

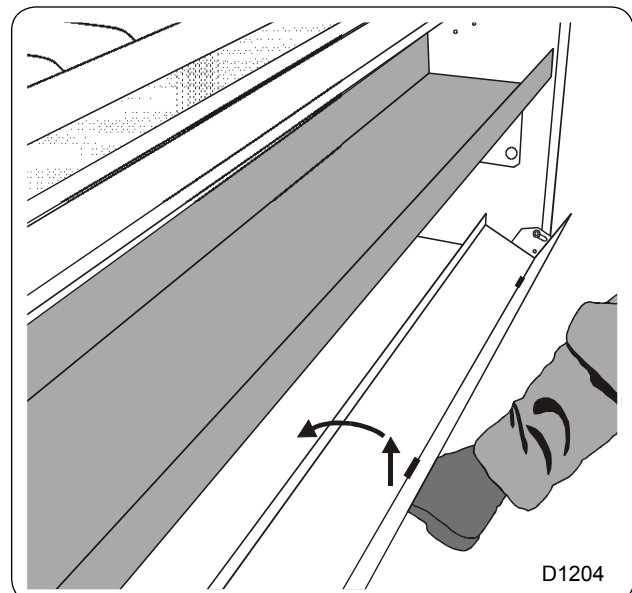
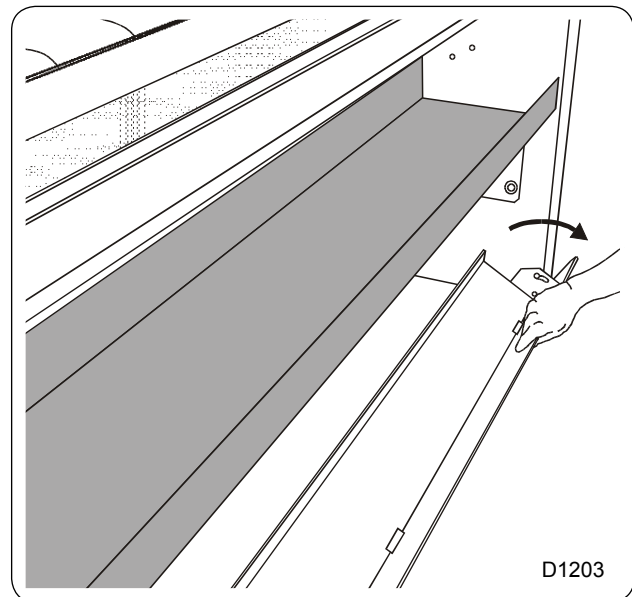

01103030	1004	17	3
Notice	Date	Page	

3. Method of use

**OPERATING
HANDBOOK**

This page is left blank on purpose.

01103030	1004	1	4
Notice	Date	Page	

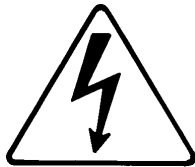

CAUTION

Disconnect the machine electrical power supply before doing any repair or servicing work.

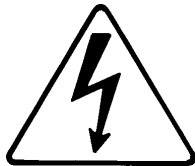

CAUTION

Do not use the machine unless it is plugged into a correctly earthed power socket complying with standards in force.

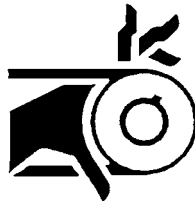

WARNING

The presence of dangerous mechanisms inside the machine can cause serious injuries. Respect all safety instructions before doing any work on the machine. Replace protective casings after doing any work.

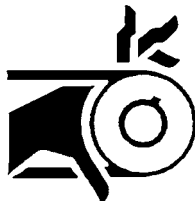

CAUTION

For your personal safety, never use the machine without the protective housings.

01103030	1004	2	4
Notice	Date	Page	

4. Safety

OPERATING HANDBOOK



CAUTION

The temperature of the ironing cylinder after use can reach 200 °C (392 °F) and can cause serious burns if you touch it. Allow the machine to cool down before doing any repair or servicing work.



SAFETY

Never iron if the mobile safety protector (hand protection bar) is not operating.



IMPORTANT

To ensure optimal operation of the machine (gas heating, electronic boards, etc.), ensure that the ambient temperature does not fall below 15°C (59 °F).

All repair and servicing work must be undertaken by a competent person.

Never wear full clothes during work (wide sleeves, ties, scarves, etc.).

Disconnect all energy sources and let the ironing cylinder cool down before doing any work on the machine.





In order to avoid any danger of fire or explosion, never use inflammable products to clean the machine.

If you smell gas, turn off the gas supply, open the windows, do not touch any switches and inform the maintenance service.

Evacuation of vapour from a dryer ironer with gas heating must never be connected to the evacuation used for a gas heating machine and a dry cleaning machine or other machine of the same type.

Locking and tagging procedure

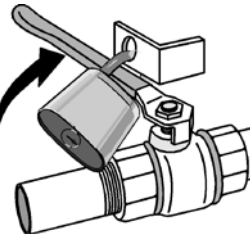
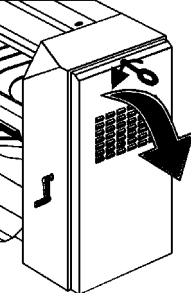
A red insert at the beginning of this instruction handbook schematically shows the locking and tagging procedure described below. If you wish, you can detach this insert and display it close to the machine to remind maintenance personnel of the safety instructions.

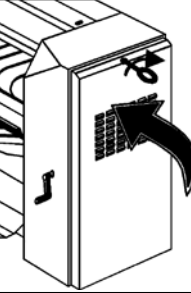
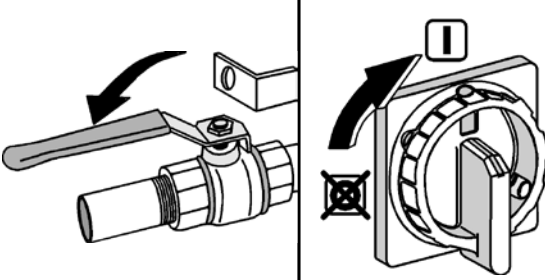
1	 <p>Always respect items 2, 3 and 4 carefully before doing any repair or maintenance work on the machine.</p>	
2	 <p>Put the main switch to Off and lock the handle with a padlock in one of the three holes provided for this purpose.</p>	 <p>Close the stop valves for the other supplies (steam, gas, thermal fluid, compressed air) to stop and lock their handle with a padlock.</p>
3	 <p>Open the fixed protectors (casings, doors) with the key provided or a special tool.</p>	 <p>Do the maintenance.</p>
 <p>Close and carefully lock the fixed protectors.</p>	4  <p>Unlock the stop valves and the main switch.</p>	

01103030	1004	4	4
Notice	Date	Page	

Safety devices

Feed safety device

The space between the feed safety flap and the drive bands is too small for you to enter your fingers. The machine stops automatically as soon as the flap is pushed in.

Protection of motors

The motors have overload protection :

- by thermomagnetic circuit breakers and
- by the electrical selector (for movement).

Restarting the machine

After each stoppage of the machine, power cut, emergency stop, or activation of the feed safety, it will then be possible to start again:

- in the case of a machine with a standard console, only after pressing the green button of the panel;
- in the case of a machine with a DIAMMS console, only after pressing one of the buttons of the control panel.

Gas heating

The gas burner is ignited and the flame is controlled by an electronic box that provides integral safety, for example if the flue draft is poor or if the gas supply is cut off.

If you have a DIAMMS console, a flashing message on the control panel signals that the system has been set to safe.

If you have a standard console, the orange lamp signals that the system has been set to safe. If this lamp flashes this signals that the machine has overheated.

A pressure switch connected to the combustion products outlet turns off the machine's heating function should extraction problems arise.

Accessibility

All casings can be disassembled using a special tool.

Heating safety device

The control panel applies an initial safety level at the time the machine starts up.

In the case of a DIAMMS console, if the temperature has not been reached after a preset time the heating order is then interrupted.

Similarly, in the case of a DIAMMS console, operation of heating is conditional on the cylinder rotating. If for any reason whatever the cylinder stops, heating of the machine stops.

A safety thermostat, which is independent of all electronic systems, limits the heating temperature of the ironing cylinder in all circumstances (except in the case of a steam heating machine).

01103030	1004	5	4
Notice	Date	Page	

Power supply failure

If there is a mains power supply failure, use the handle to remove any washing engaged in the machine. If the temperature is too high, use the handle to feed some wet washing and protect the ironing bands.

01103030	1004	6	4
Notice	Date	Page	

4. Safety

OPERATING
HANDBOOK



SAFETY

Make sure that the protection casings are in position before use.

Complementary instructions for operation

Check daily that the hand safety bar is working correctly, the machine must stop when you press it. The screen on control panel displays "Emergency Stop/ Reset Push Button". Press any key to resume ironing.

Ironing Temperature Display

The control enclosure includes an electronic thermostat panel which shows in real time the temperature of the ironing cylinder.

A running temperature over the selected temperature is normal. This happening is not a failure of measuring devices but it is due to heating inertia.

In automatic mode, temperature and speed management are handled by the machine itself.

Fire-related risks.

Should a fire breakout inside the machine, it is recommended that you use a CO₂ extinguisher.

Note : in the case of a machine using gas heating, it is **strictly forbidden** to attempt to put out the fire before having first turned off the gas inlet valve.

The client must ensure conformity towards the Labour Code and his supplier of fire-fighting equipment who issues the Q4 certificate to him.

Repair and maintenance work on the machine.

All work on the machine must be carried out by qualified personnel, able to carry out the work required.

Ensure that the applicable safety conditions for the destination country are fully observed.

4. Safety

01103030	1004	7	4
Notice	Date	Page	

This page is left blank on purpose.

01103030	1004	1	5
Notice	Date	Page	

5. Operating incidents

Encountered problem	Cause of problem	Solution
<p>The linen remains stuck to the cylinder</p>	<p>Your washing is not rinsed correctly</p> <p>if the washing is insufficiently rinsed.</p> <p>Check that ironer separating ribbons are intact.</p> <p>Check the cylinder temperature.</p> <p>The washing is not sufficiently spun.</p> <p>Your linen is starched</p>	<p>Check rinsing with a 1 % phenolphthalein solution diluted in alcohol. If this colorless liquid turns to pink on the washing as it comes out of the washing machine, and it still contains detergents.</p> <p>Increase the number of rinsings if necessary or reduce product doses.</p> <p>There is a risk of starch deposits forming on the cylinder</p>
<p>When the linen comes off the dryer-ironer it is not dry</p>	<p>Your washer-spin dryer has a spin rating of below 300G.</p> <p>Check the drying quality of your washing machine.</p> <p>The ironing speed is too high.</p> <p>The ironing temperature is too low.</p> <p>The linen that you are trying to iron is too thick.</p> <p>Check operation of the heating.</p> <p>Check operation and cleanliness of the vacuum intake system.</p> <p>Check the condition of ironing bands (fibers containing scale).</p> <p>Check the pressure of the ironing roller on the ironing cylinder.</p>	<p>You should plan on a short pre-drying session in a dryer (5 – 10 mins).</p> <p>The residual moisture content of the washing should be about 50 %.</p> <p>Reduce the ironing speed.</p>

01103030	1004	2	5
Notice	Date	Page	

Encountered problem	Cause of problem	Solution
<p>The heating does not work, or works badly</p>	<p>Check the temperature preselection.</p> <p>Check the safety thermostat.</p> <p>Check to see if the panel is showing overheating or a high temperature.</p> <p>Check the cylinder's rotation detection system.</p> <p>Gas heating Check the gas inlet.</p> <p>Clean pressure reducer filters.</p> <p>Check electronic ignition.</p> <p>Check the position of the ignition electrodes and flame control.</p> <p>Check operation of the gas solenoid valve.</p> <p>The flame is yellow</p> <p>Electrical heating Check heating contacts KM6, KM7 and KM8.</p> <p>Check heating resistances.</p> <p>Check resistance connections.</p> <p>Check phases.</p>	<p>Check the panel's sensors.</p> <p>Check that the vapour intake fan is working and is turning in the right direction.</p> <p>Check that air inlets are not blocked.</p> <p>Check the combustion products exhaust flue.</p> <p>Check injector calibration.</p> <p>Clean machine air inlet filters.</p>

01103030	1004	3	5
Notice	Date	Page	

5. Operating incidents

OPERATING
HANDBOOK

Encountered problem	Cause of problem	Solution
The machine temperature drops	<p>Check the sensor in the thermostat regulation system.</p> <p>Check the thermostat by measuring the cylinder temperature with a thermometer.</p> <p>Check that the regulation shoe is in contact with the cylinder.</p>	
The machine stops suddenly	<p>Check the electric power supply.</p> <p>Check the hand safety flap switches S5 and S6.</p> <p>Check the movement and ventilation fans.</p> <p>Check circuit breakers.</p>	

Static electricity

- Synthetic textiles are used increasingly in laundry. The low rate of relative moisture on output from drying allows high ironing speeds, which leads to production of harmful static electricity when the linen is ironed in the machine.
- Any friction generates static electricity. Remember the plastic ruler people rub over their pullover to attract little bits of paper. With the same causes producing the same effects, the linen being subjected to friction in the course of ironing, the rubbing of the linen against the cylinder generates static electricity. If too much static electricity builds up, friction has to be reduced, which can be done by removing the driving chain of the press-cylinder to reduce the generation of static electricity.

01103030	1004	4	5
Notice	Date	Page	

Linen colouring

- The brown coloring is due to detergent residues, and will disappear at the next washing.
- Colouring caused by the temperature being too high is permanent. Reduce the ironing temperature or increase the ironing speed.
- The washing should be correctly rinsed so that it does not turn yellow and does not make the cylinder dirty.
 - Check the quality of the washing water (TH/TAC).
 - Check the washing and rinsing cycles (see "phenolphthalein" operating incidents).
 - Check incrustation of the washing (ash content).

The feed bands are not turning

- This type of incident is normal when it only affects a few bands.
When washing will not engage any more, adjust the tension of all the bands by changing the setting of the feed table.
Do not overtighten the bands.
The band must stop turning when you press on it with your finger. It must start again when you remove your finger.

Complementary instructions for starting up a machine with gas heating.

The message "**Error Gas Ignition**" is flashing on display screen during 30 seconds to show that the gas burner is being ignited. If this message is still displayed after 6 seconds, there may be an ignition fault, a failure in gas valve opening or a lack of gas.
Switch the machine off and call your local repairman if this occurs regularly.

About 12 minutes is necessary to warm up.

Note:

Do not forget to open the stop valve on the gas supply line before starting to use the machine, and then close it again after use.

The noise at the inter-ignition is not an explosion. It is a normal phenomenon.

01103030	1004	5	5
Notice	Date	Page	

Overheating of cylinder sides

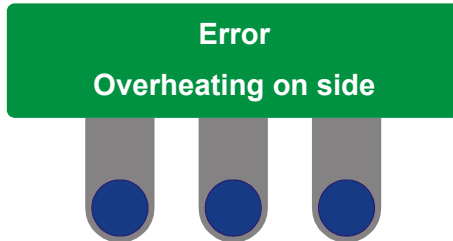

Overheating of cylinder sides (when feeding is carried out on the centre of the cylinder too often)

In the event that one of the two sides of the cylinder overheats due to it being partially used, a flashing message will be displayed on the screen, alternately with the service screen.

The heating system of the machine will remain shut down while this flashing message is displayed.

To continue ironing, allow the cylinder to cool until the flashing display disappears.

Overheating of centre of cylinder

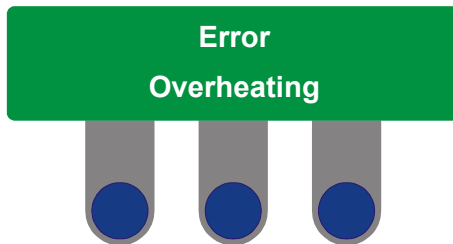

Overheating of centre of cylinder (when small linen units are too often fed on the centre of the cylinder)

In the event that the centre of the cylinder overheats due to it being used laterally, a flashing message will be displayed on the screen alternately with the operating screen.

The heating system of the machine will remain shut down while this message continues to be displayed.

To continue ironing, allow the cylinder to cool until the flashing display disappears.

01103030	1004	6	5
Notice	Date	Page	

Converter fault

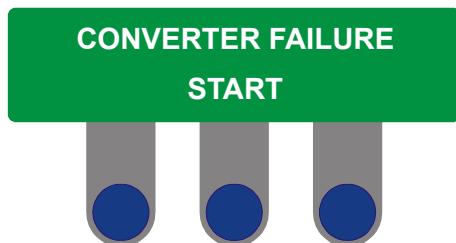

"Converter failure" message

If this message appears on the screen, the converter has developed a fault. Please refer to the converter manual for information repairing the fault.

The machine will only be able to be restarted once the fault has been repaired.

To reinitialise the machine, press the central key.

If the fault remains, switch off then switch back on the power supply using the main switch.

Fault Emergency stop



Message: «Emergency stop-check button»

If the screen displays this message, one of the emergency stop buttons has been triggered. The machine enters safety mode, the heating is turned off and the cylinder stops.

Check why the button was pressed and then reset it. The screen should now display this message :



You can now press the central button on the panel to return to the machine operation mode.

If resetting the button does not solve the problem, you should then check the others.

01103030	1004	7	5
Notice	Date	Page	

Gas burner ignition fault (only for machines using gas heating)

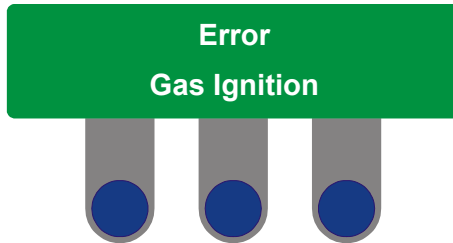

"Gas ignition fault" message (only on gas-heated machines).

The screen will alternately display this flashing message and the service screen. This means that the lighting of the gas burners has been requested.

If this message has been displayed over 30 seconds, the gas burner is not ignited. The heating system falls into safety state and heating is cut off. Try again and follow the starting procedure.

Press any key to display the following menu.

After an additional failure, please check the gas heating running. If the fault remains, consult your after-sales service.

Reset the igniter (only for machines using gas heating)

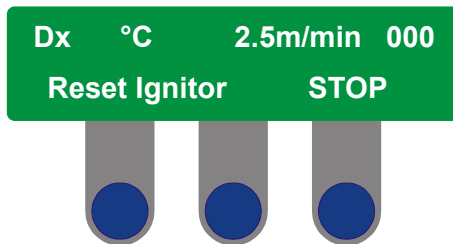

Message: «Reset igniter»

The message on the screen will then ask you if you wish to reset the igniter.

Press on one of the two buttons on the left to restart the gas igniter.

Press the «STOP» button to stop the machine.

Fault with the heating system

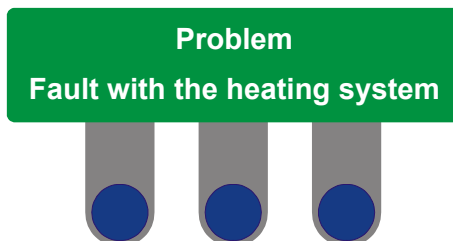

Message: «Problem - fault with the heating system».

The screen appears if, after a certain time (approximately 20 minutes) the cylinder temperature remains below 100°C (212 °F).

Try to restart the machine.

If the problem continues, please consult your after-sales service department.

01103030	1004	8	5
Notice	Date	Page	

This page is left blank on purpose.

01103030	0905	1	6
Notice	Date	Page	

Preventive maintenance

CAREFUL

SHUT OFF THE POWER SUPPLY OF THE MACHINE BEFORE ANY MAINTENANCE OR REPAIR INTERVENTION IS CARRIED OUT AND MAKE SURE THAT THE CYLINDER IS COLD.

DAILY (8 h)

1. Check that the finger protection is working.

WEEKLY (40 h)

2. Clean the fan grates of motors.
3. Clean the stripper fingers and the thermostat attachment.
4. Clean the ironer external, from dust.
- G. Clean the fluff filter with suction device.
- G. Clean the cover filter with suction device.

MONTHLY (170 h)

5. Check that the parting strips are intact and replace if necessary.

EVERY SIX MONTH (1000 h)

6. Slightly grease the chains (see lubrication table in the handbook).
7. Clean and check the support rollers of the cylinder.
8. Check that the crank is working.
9. Check that the electrical connections are shut off on the supply terminal.
10. Clean the whole suction device.
11. Check the heating elements, wires and connections (only for electric heated machines).
12. Clean the gas filters (only for gas heated machines).
13. Check the condition and tension of the ironing strips and of the clips.
14. Check the feeding bands, their drive and the clamps.
15. Check that the thermostat is working.
16. Clean the ironer internal, from dust.

ONCE A YEAR (2000 h)

- 17. Check if the cylinder has any deposits of detergent or lime. Clean if necessary.
- 18. Check and clean the outer pipes.
- G. Clean the fluff filter with suction device.
- G. Clean the cover filter with suction device.
- G. Clean the inner gas burner with suction device.
- G. Check the sight of the ceramic plates joints and change them if necessary.

EVERY THREE YEAR (6000 h)

- G. Clean the fluff filter with suction device.
- G. Clean the cover filter with suction device.
- G. Clean the ceramic plates with suction device.
- G. Change the high temperature joints made of mineral wool.
- G. Check the tightness of the venturis.

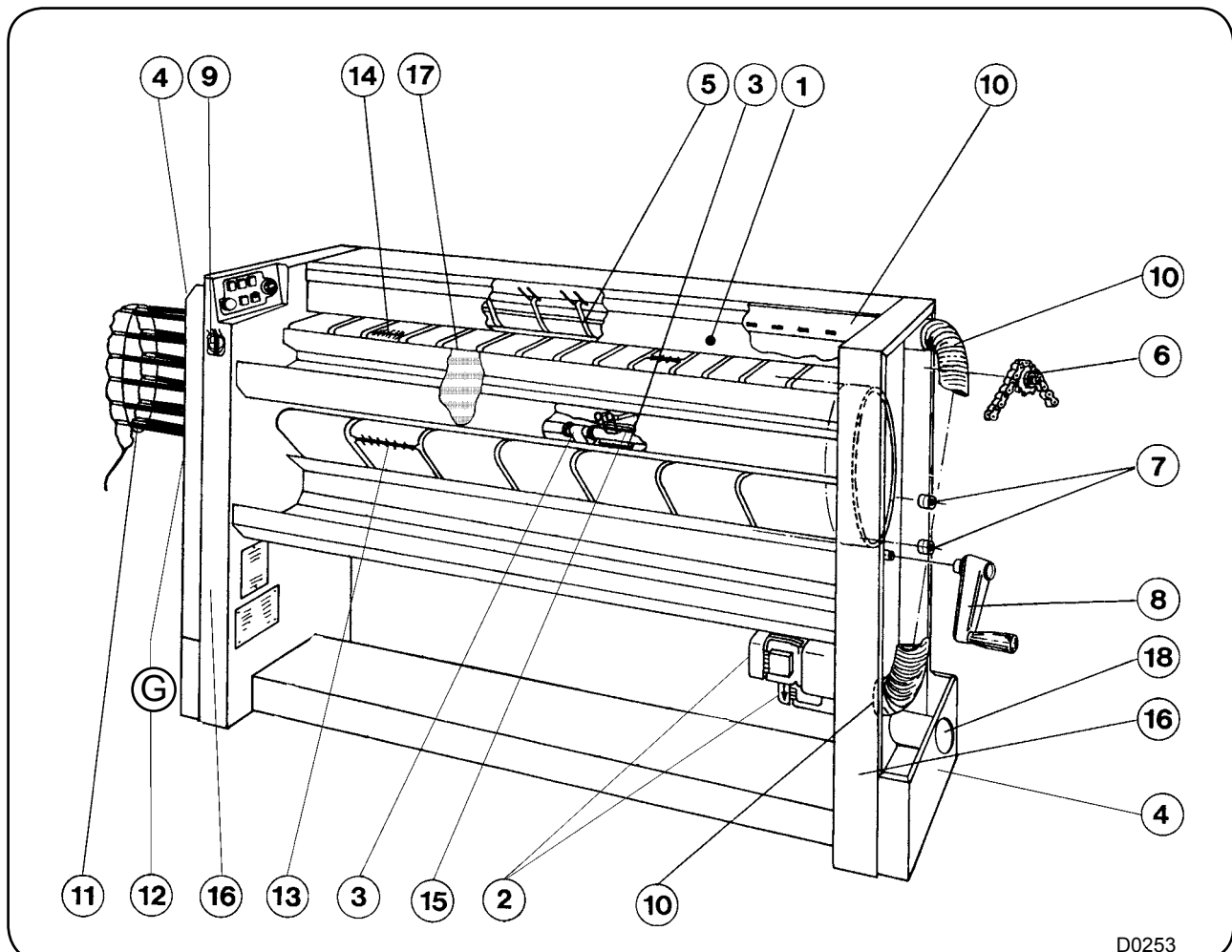

01103030	0905	3	6
Notice	Date	Page	

6. Maintenance

OPERATING
HANDBOOK



SAFETY

Any repairing or maintenance operation should be carried out by a specialist.



CAUTION

For an optimal service of your machine, execute this instructions at regular intervals and according to the frequency of use.

Check of the detaching cords or pressure roller :

It is necessary to lift up the upper casing of the machine.

Proceed as follows :

- Stop the machine.
- Dismantle the side casing with the key.
- Do not touch the screws (A) which serve as a link with the casing, a screw in each caisson.
- Unscrew and remove the screws (B). **Careful** : do not touch the screws (C) which are used for the joint of the finger protection device.

Now you can lift up the upper casing in order to access to the detaching cords.

After the intervention, hinge the upper casing down, reset and tighten the screws, then reassemble the side casings.

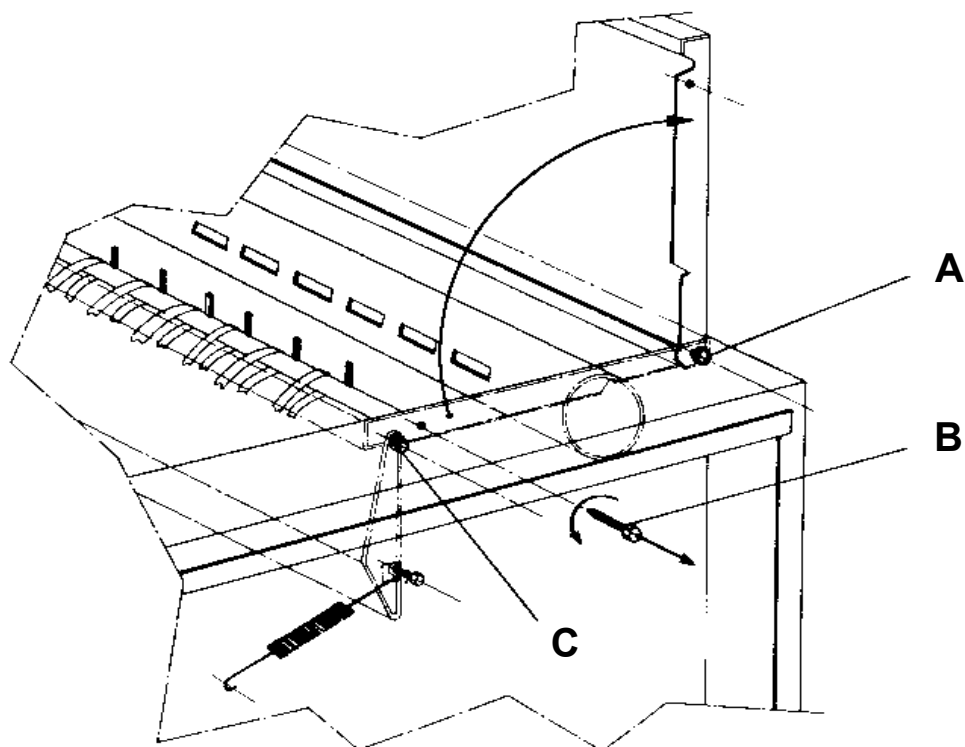

01103030	1004	5	6
Notice	Date	Page	

Replacing ironing bands

- Remove the feed tray to obtain easy access to the ironing bands.
- Remove staples from the two ends of the bands to be replaced and staple the end of the old band with the end of the new band.
- Rotate the cylinder using the handle.
- Unstaple the ends of the old and the new band, and staple the two ends of the new band together.
- Do the same for the other bands.
- Replace the feed tray.



CAUTION

The tension of the ironing bands was adjusted in the factory with the machine hot.

Never retension the bands.

Their tension must be as low as possible (just enough to drive them) since excessive tension will cause fast wear of these bands.

Remember these comments if you need to make an adjustment or a replacement.

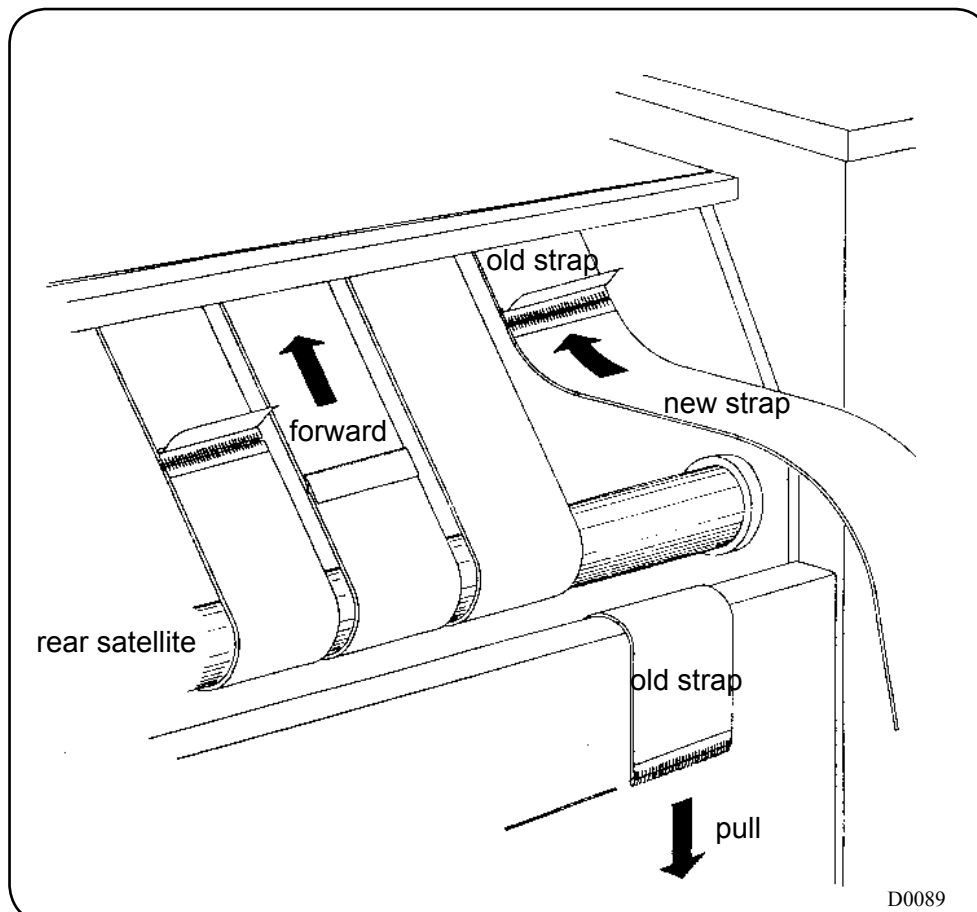

01103030	1004	6	6
Notice	Date	Page	

Motors :

The fan motor is permanently lubricated.
The movement motor is permanently lubricated.

Bearings :

Permanently lubricated.

Heat control :

Make sure that the shoe of the thermostatic control and the safety control devices are always clean and in cylinder contact.

Gas heating :

Check annually the good working of the burner (removal and blowing).
Check and clean the lint filter regularly.

Cylinder :

The cylinder must be kept very clean to make ironing easier and must be of a very high quality.

Deposits of washing powder or lime must be removed as soon as they start to affect the quality of the ironing.

The use of VERY FINE saddle grinder ONLY is recommended (grain 180 or Scotch Brite 3M BFB-AM).

THIS SHOULD BE RUBBED IN THE SAME DIRECTION AS THE LINEN IS PASSED THROUGH THE MACHINE.





Should the machine be stopped for a long period, in order to avoid any oxidation of the cylinder, a sheet impregnated with paraffin wax should be fed through the machine.

Using an old sheet, grate a little paraffin wax onto half of the unfolded sheet, fold in half and then run it through the flatwork-ironer while it is still hot enough.

If the machine is to be left unused for a longer period, it is advisable to oil the cylinder slightly (anti-rust oil ref. 96010012).

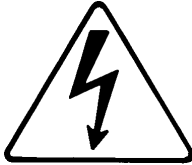
01103030	1004	1	7
Notice	Date	Page	

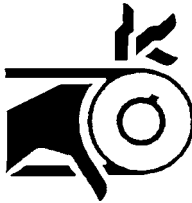
Explanation of graphic symbols

	<p>A flash of lightning with an arrow at its end displayed inside an equilateral triangle, warns the user about the presence of uninsulated "dangerous current" sufficient in intensity to cause electrocution.</p>
	<p>An exclamation mark inside an equilateral triangle offers the user important advice about usage, servicing and hazardous conditions.</p>
	<p>This symbol warns the user that there are mechanisms inside the machine which can be dangerous. The protective housing must be in place during use.</p>
	<p>This symbol warns the user of the presence of high temperatures which could cause severe burns. Some surfaces can reach close to 200 °C (392 °F).</p>

Explanation of Washing symbols

(ISO 3758:2005 standard)

To overcome language barriers, the following are symbols used internationally to give you guidance and recommendations when washing different textiles.

Washing

The tub symbolizes washing.

	Max. washing temperature in °C	Mechanical action
D1232	95	normal
D1233	95	mild
D1234	70	normal
D1235	60	normal
D1236	60	mild
D1237	50	normal
D1238	50	mild
D1239	40	normal
D1240	40	mild
D1241	40	very mild
D1242	30	normal
D1243	30	mild
D1244	30	very mild
D1245	40	Wash by hand
D1246		Do not wash

Bleaching

The triangle symbolizes bleaching.

D1247	Bleaching allowed (chlorine or oxygen).
D1248	Bleaching allowed (only oxygen).
D1249	Do not bleach.

Dry or water cleaning

The circle symbolizes dry or water cleaning.

D1253	Normal dry cleaning with perchloroethyl, solvent of hydrocarb.
D1254	Mild dry cleaning with perchloroethyl, solvent of hydrocarb.
D1255	Normal dry cleaning with solvent of hydrocarbon.
D1256	Mild dry cleaning with solvent of hydrocarbon.
D1257	Do not dry clean.
D1258	Normal water cleaning.
D1259	Mild water cleaning.
D1260	Very mild water cleaning.

Drying

The circle in a square symbolizes tumble drying.

D1261	Can be put in a tumble dryer. Normal temperature.
D1260	Can be put in a tumble dryer. Lower temperature.
D1262	Do not put in a tumble dryer.

Ironing

The iron symbolizes the domestic ironing and pressing process.

D1261	Max. temperature 200 °C.
D1262	Max. temperature 150 °C.
D1263	Max. temp. 110 °C. The steam can cause irreversible damages.
D1264	Do not iron.

01103030	1004	3	7
Notice	Date	Page	

7. Appendices

OPERATING HANDBOOK

Conversion of measurement units

The following is a list of correspondences of the main frequently used units, to avoid the need to use measurement unit conversion tables.

bar :	1 bar = 100 000 Pa 1 bar = 1.019 7 kg/cm ² 1 bar = 750.06 mm Hg 1 bar = 10 197 mm H ₂ O 1 bar = 14.504 psi	1 kg/cm ² = 10 000 mm H ₂ O 1 kg/cm ² = 735.557 6 mm Hg
british thermal unit :	1 Btu = 1 055.06 J 1 Btu = 0.2521kcal	pound : 1 lb = 453.592 37 g
calorie :	1 cal = 4.185 5 J 1 cal = 10 ⁻⁶ th 1 kcal = 3.967 Btu 1 cal/h = 0.001 163 W 1 kcal/h = 1.163 W	meter : 1 m = 1.093 61 yd 1 m = 3.280 83 ft 1 m = 39.37 in
continental horse power :	1 ch = 0.735 5 kW 1 ch = 0.987 0 HP	cubic meter : 1 m ³ = 1 000 dm ³ 1 m ³ = 35.314 7 cu ft 1 dm ³ = 61.024 cu in 1 dm ³ = 0.035 3 cu ft
cubic foot :	1 cu ft = 28.316 8 dm ³ 1 cu ft = 1 728 cu in	pascal : 1 Pa = 1 N/m ² 1 Pa = 0.007 500 6 mm Hg 1 Pa = 0.101 97 mm H ₂ O 1 Pa = 0.010 197 g/cm ² 1 Pa = 0.000 145 psi 1 MPa = 10 bar
cubic inch :	1 cu in = 16.387 1 dm ³	psi : 1 psi = 0.068 947 6 bar
foot :	1 ft = 304.8 mm 1 ft = 12 in	thermie : 1 th = 1 000 kcal 1 th = 10 ⁶ cal 1 th = 4.185 5 x 10 ⁶ J 1 th = 1.162 6 kWh 1 th = 3 967 Btu
gallon (U.K.) :	1 gal = 4.545 96 dm ³ or l 1 gal = 277.41 cu in	watt : 1 W = 1 J/s 1 W = 0.860 11 kcal/h
gallon (U.S.A.) :	1 gal = 3.785 33 dm ³ or l 1 gal = 231 cu in	watt-hour : 1 Wh = 3600 J 1 kWh = 860 kcal
horse power :	1 HP = 0.745 7 kW 1 HP = 1.013 9 ch	yard : 1 yd = 0.914 4 m 1 yd = 3 ft 1 yd = 36 in
inch :	1 in = 25.4 mm	temperature degrees :
joule :	1 J = 0.000 277 8 Wh 1 J = 0.238 92 cal	0 °K = -273.16 °C 0 °C = 273.16 °K t °C = 5/9 (t °F-32) t °F = 1.8 t °C + 32
kilogramme :	1 kg = 2.205 62 lb	
kg/cm² :	1 kg/cm ² = 98 066.5 Pa 1 kg/cm ² = 0.980 665 bar	

LUBRIFICATION TABLE

USES	Rolling bearings Bearings	Rolling bearings Bearings high temperature	Assembly paste (fretting corrosion)	Bare gears Chains shafts Thread Slides	Flange joints Union pipes Steam circuits	Reducers with wheels and screws	Reducers with gears	Circuits and pneumatic devices	
TYPES OF LUBRICANTS AND STANDARDIZATION	Lithium soap grease	Lithium soap grease + silicone oil	Lithium soap paste + mineral oil + mineral solid greases	Lithium soap grease with MOS2 additive	Graphite grease mini 60% graphite, special leakproof	Extreme high pressure oil	Extreme high pressure oil	Inhibited oil SAE5	
TEMPERATURE LIMIT RANGE	-20°C + 140°C -4°F + 284°F	-40°C + 200°C -40°F + 392°F	-20°C + 150°C -4°F + 302°F	-20°C + 135°C -4°F + 275°F	-30°C + 700°C -22°F + 1292°F	0°C + 100°C 32°F + 212°F	0°C + 120°C 32°F + 248°F	+10°C + 65°C +50°F + 149°F	
RECOMMENDED	CELTIA G2	NTN SH44 M	ALTEMP Q NB 50	MI-SETRAL 43N	GRACO AF 309	REDUCTELF SP150	REDUCTELF SP200	LUBRAK ATL SAE 5W	
CODE PRODUCT	96 011 011	96 011 019	96 011 014	96 011 000	96 011 004	96 010 001	96 010 004	96 010 030	
CORRESPONDENCE	ANTAR	ROLEXA 2		EPOXA MO 2		EPOXA Z 150	EPOXA Z 220	MISOLA AH	
	BP	LS EP 2				ENERGOL CRXP 150	ENERGOL CRXP 220	SHF 22	
	CASTROL	SPEEROL EP2				ALPHA SP 150	ALPHA SP 220		
	ELF	EP2		STATERMA MO10		REDUCTELF SP150	REDUCTELF SP220	SPINEF 22	
	ESSO	BEACON EP2		MULTI PURPOSE GREASE MOLY		SPARTAN EP150	SPARTAN EP220	SPINESSO 22	
	FINA	MARSON EP2				GIRAN SR150	GIRAN SR220		
	GBSA				BELLEVILLE N				
	GRAFOIL					GRACO AF 309			
	KLUBER	CENTOPLEX 2	UNISILKON L50Z	ALTEMP Q.NB50	UNIMOLY GL82	WOLFRACOAT C	LAMORA 150	LAMORA 220	CRUCOLAN 22
	MOBIL	MOBILUX					MOBILGEAR 629	MOBILGEAR 630	DTE 24
	KERNITE	LUBRA K LC			LUBRA K MP		TOP BLENB ISO 80W90	TOP BLENB ISO 220	LUBRA K ATL SAE5W
	SETRAL				MISETRAL 43N				
	SHELL	ALVANIA R2			RETINA AM		OMALA 150	OMALA 220	TELLUS 22
	TOTAL	MULTISS EP2					CARTER EP150	CARTER EP220	EQUIVIS 22
	MOLYKOTE		MOLYCOTE 44	PATE DX					
	OPAL	GEVAIR SP			SUPER MOS 2		GEAROPAL GM 65 ISO 150	GEAROPAL GM 75 ISO 220	HYDROPAL HO 110 HM++22
ITECMA	GRL-ULTRA	VULCAIN	SILUB-P	GMO	LHT-C	DURAGEAR BL	DURAGEAR BL	AEROSYN	
DOW CORNING		SH 44 N							



Share more of our thinking at www.electroluxprofessional.com