

# User manual Tumble dryer

TE1220E, TE1220G



**Electrolux**  
PROFESSIONAL



# Contents

---

## Contents

1	Safety Precautions .....	5
1.1	Gas heated tumble dryer: .....	7
1.2	General safety information.....	7
1.3	Commercial use only.....	7
1.4	Copyright .....	7
1.5	Symbols.....	8
2	Warranty terms and exclusions.....	9
3	Program description .....	10
3.1	General.....	10
3.2	Control panel illustration .....	10
3.3	Program description.....	10
3.4	Program running description .....	11
4	Handling .....	12
4.1	Load .....	12
4.2	How to start the machine .....	12
4.2.1	Select program.....	12
4.2.2	Show program drying time on the display .....	12
4.3	Press Start Button.....	12
4.4	When program has ended .....	13
5	Error codes .....	14
6	Maintenance .....	15
7	Technical data .....	17
8	Disposal information .....	18
8.1	Disposal of appliance at end of life .....	18
8.2	Disposal of packing.....	18

The manufacturer reserves the right to make changes to design and component specifications.



## 1 Safety Precautions

- Servicing shall be carried out only by authorized personnel.
- Only authorized spare parts, accessories and consumables shall be used.
- The machine is not to be used if industrial chemicals have been used for cleaning.
- Do not dry unwashed items in the machine.
- Items that have been soiled with substances such as cooking oil, acetone, alcohol, petrol, kerosene, spot removers, turpentine, waxes and wax removers should be washed in hot water with an extra amount of detergent before being dried in the machine.
- Items such as foam rubber (latex foam), shower caps, waterproof textiles, rubber backed articles and clothes or pillows fitted with foam rubber pads should not be dried in the machine.
- Fabric softeners or similar products should be used as specified by the fabric softener instructions.
- The final part of a drying cycle occurs without heat (cool down cycle) to ensure that the items are left at a temperature that ensures that the items will not be damaged.
- Remove all objects from pockets such as lighters and matches.
- **WARNING.** Never stop the machine before the end of the drying cycle unless all items are quickly removed and spread out so that the heat is dissipated.
- Adequate ventilation has to be provided to avoid the back flow of gases into the room for appliances burning other fuels, including open fires.
- Exhaust air must not be discharged into a flue which is used for exhausting fumes from appliances burning gas or other fuels.
- The machine must not be installed behind a lockable door, a sliding door or a door with a hinge on the opposite side to that of the machine in such a way that a full opening of the machine is restricted.
- If the machine has a lint trap this has to be cleaned frequently.
- The lint must not be accumulated around the machine.
- **DO NOT MODIFY THIS APPLIANCE.**
- When performing service or replacing parts, the power must be disconnected.
- When the power is disconnected, the operator must see that the machine is disconnected (that the plug is removed and remains removed) from any point to which he has access. If this is not possible, due to the construction or installation of the machine, a disconnection with a locking system in the isolated position shall be provided.
- In accordance with the wiring rules: mount a multi-pole switch prior to the machine to facilitate installation and service operations.
- **WARNING:** The appliance must not be supplied through an external switching device, such as a timer, or connected to a circuit that is regularly switched on and off by a utility.
- If different rated voltages or different rated frequencies (separated by a /) are stated at the machine data plate, instructions for adjusting the appliance for operation at the required rated voltage or rated frequency are stated in the installation manual.
- Stationary appliances not fitted with means for disconnection from the supply mains having a contact separation in all poles that provide full disconnection under overvoltage category III, the instructions state that means for disconnection must be incorporated in the fixed wiring in accordance with the wiring rules.
- The openings in the base, shall not be obstructed by a carpet.

- Oil-affected items can ignite spontaneously, especially when exposed to heat sources such as in a tumble dryer. The items become warm, causing an oxidation reaction in the oil. Oxidation creates heat. If the heat cannot escape, the items can become hot enough to catch fire. Piling, stacking or storing oil-affected items can prevent heat from escaping and so create a fire hazard.
- If it is unavoidable that fabrics that contain vegetable or cooking oil or have been contaminated by hair care products be placed in a tumble dryer they should first be washed in hot water with extra detergent – this will reduce, but not eliminate, the hazard.
- Maximum mass of dry cloth: 12 kg.
- A-weighted emission sound pressure level at working stations: <68 dB(A).
- If the supply cord is damaged, it must be replaced by the manufacturer, its service agent or similarly qualified persons in order to avoid a hazard.
- Additional requirements for the following countries; AT, BE, BG, HR, CY, CZ, DK, EE, FI, FR, DE, GR, HU, IS, IE, IT, LV, LT, LU, MT, NL, NO, PL, PT, RO, SK, SI, ES, SE, CH, TR, UK:
  - The appliance can be used in public areas.
  - This appliance can be used by children aged from 8 years and above and persons with reduced physical, sensory or mental capabilities or lack of experience and knowledge if they have been given supervision or instruction concerning use of the appliance in a safe way and understand the hazards involved. Children shall not play with the appliance. Cleaning and user maintenance shall not be made by children without supervision.
- Additional requirements for other countries:
  - This appliance is not intended for use by persons (including children) with reduced physical, sensory or mental capabilities, or lack of experience and knowledge, unless they have been given supervision or instruction concerning use of the appliance by a person responsible for their safety. Children should be supervised to ensure that they do not play with the appliance.

### 1.1 Gas heated tumble dryer:

- Before installation, check that the local distribution conditions, nature of gas and pressure and the adjustment of the appliance are compatible.
- The machine is not to be installed in rooms containing cleaning machines with perchloroethylene, TRICHLOROETHYLENE or CHLOROFLUOROCONTAINING HYDROCARBONS as cleaning agents.
- NOTE: it is pointed out that the connection and commissioning of appliances complying with this standard are subject to observance of the installation regulations in force in the countries where these appliances are marketed.
- Connection to the appliance shall be made with a flexible hose suitable for the appliance category in accordance with national installation regulations of the country of destination and that in case of doubt the installer shall contact the supplier.
- The appliance should be installed on non-flammable materials for the floor, worktop and/or wall close to the appliance if required.
- If you can smell gas:
  - Do not switch on any equipment
  - Do not use electrical switches
  - Do not use telephones in the building
  - Evacuate the room, building or area
  - Contact the person responsible for the machine

### 1.2 General safety information

In order to prevent damage to the electronics (and other parts) that may occur as the result of condensation, the machine should be placed in room temperature for 24 hours before being used for the first time.







### 1.3 Commercial use only

The machine/machines covered by this manual is/are made for commercial and industrial use only.

### 1.4 Copyright

This manual is intended solely for consultation by the operator and can only be given to third parties with the permission of Electrolux Professional AB company.

## 1.5 Symbols

	Caution
	Caution, hot surface
	Caution, high voltage
	Warning, risk of fire / flammable material
	Danger, crush hazard
	Read the instructions before using the machine



## 2 Warranty terms and exclusions

If the purchase of this product includes warranty coverage, warranty is provided in line with local regulations and subject to the product being installed and used for the purposes as designed, and as described within the appropriate equipment documentation.

Warranty will be applicable where the customer has used only genuine spare parts and has performed maintenance in accordance with Electrolux Professional user and maintenance documentation made available in paper or electronic format.

Electrolux Professional strongly recommends using Electrolux Professional approved cleaning, rinse and descaling agents to obtain optimal results and maintain product efficiency over time.

The Electrolux Professional warranty does not cover:

- service trips cost to deliver and pick up the product;
- installation;
- training on how to use/operate;
- replacement (and/or supply) of wear and tear parts unless resulting from defects in materials or workmanship reported within one (1) week from the failure;
- correction of external wiring;
- correction of unauthorized repairs as well as any damages, failures and inefficiencies caused by and/or resulting from:
  - insufficient and/or abnormal capacity of the electrical systems (current/voltage/frequency, including spikes and/or outages);
  - inadequate or interrupted water supply, steam, air, gas (including impurities and/or other that does not comply with the technical requirements for each appliance);
  - plumbing parts, components or consumable cleaning products that are not approved by the manufacturer;
  - customer's negligence, misuse, abuse and/or non-compliance with the use and care instructions detailed within the appropriate equipment documentation;
  - improper or poor: installation, repair, maintenance (including tampering, modifications and repairs carried out by third parties not authorized third parties) and modification of safety systems;
  - Use of non-original components (e.g.: consumables, wear and tear, or spare parts);
  - environment conditions provoking thermal (e.g. overheating/freezing) or chemical (e.g. corrosion/oxidation) stress;
  - foreign objects placed in- or connected to- the product;
  - accidents or force majeure;
  - transportation and handling, including scratches, dents, chips, and/or other damage to the finish of the product, unless such damage results from defects in materials or workmanship and is reported within one (1) week of delivery unless otherwise agreed;
- product with original serial numbers that have been removed, altered or cannot be readily determined;
- replacement of light bulbs, filters or any consumable parts;
- any accessories and software not approved or specified by Electrolux Professional.

Warranty does not include scheduled maintenance activities (including the parts required for it) or the supply of cleaning agents unless specifically covered within any local agreement, subject to local terms and conditions.

Check on Electrolux Professional website the list of authorized customer care.

## 3 Program description

### 3.1 General

The machine is equipped with four programs adapted to the range of use to which the machine is intended different markets use different programs. The following program description is a short description of some examples of programs that can be used.

It is recommended to follow the care labelling of the garment as far as possible.

For best possible drying result it is advisable to dry garments of the same quality for each drying cycle.

#### Note!

**Do not tumble dry wool or silk.**

### 3.2 Control panel illustration

The display control panel allows the selection of the main drying programs.

The panels consist of program selection buttons (A), a start button (B) and a display (C) which shows the price for each program and the drying time designated for each program.

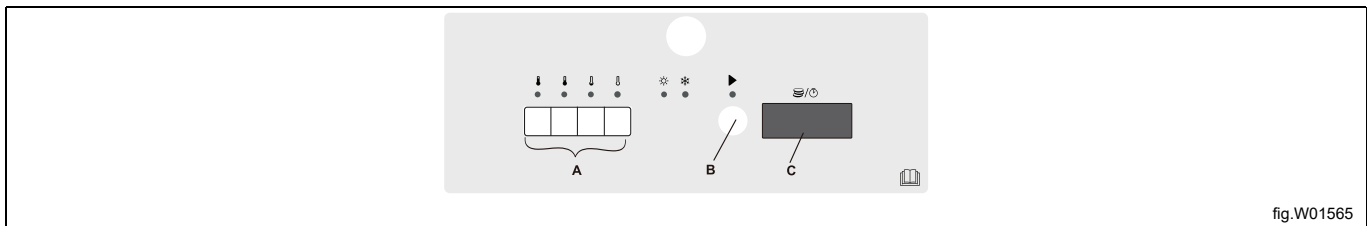

fig.W01565

Explanation of the control panel.

A	Program selection buttons
B	Start Button
C	Display indicating program time and price of the programs

### 3.3 Program description

There are four types of programs: high/medium/low/no heating temperature programs.

The following table shows some examples of available programs and a short description of those:

Programs	Description
	Cotton and terry. high temperature The program will stop when the time is up.
	Cotton and terry. medium temperature The program will stop when the time is up.
	Synthetic (example of synthetic fabrics: polyester, polyamide, polyacrylic and elastan), viscose, polycotton and delicate fabrics. low temperature The program will stop when the time is up.
	Airing bedspreads, duvets and bedclothes. no heating temperature The program will stop when the time is up.

---

### 3.4 Program running description

The machine is equipped with four programs adapted to the range of use to which the machine is intended.

The machine offers four standard drying programs. Detailed descriptions of these procedures are given in Chapter [Control panel illustration](#). For coin operated machines, "Price per program", "Time for each program", and "Time for additional coin(s) or press" settings can be assigned to each program individually.

High, Medium, and Low drying programs are divided into two segments: a Heating period and a Cool Down period. Drying time and temperature settings for each program can be adjusted with the service menu registers. Heating and Cool Down times can also be adjusted using the registers in the service menu. During heating, the display shows "d xx" where "xx" are the remaining drying time minutes. During cool down the display shows "c xx" where "xx" is the remaining cool down time. The program stops at "c 00".

## 4 Handling

### 4.1 Load

Load the goods into the machine according to recommendations and close the door.

**Make sure the filter compartment is clean and clean if necessary.**

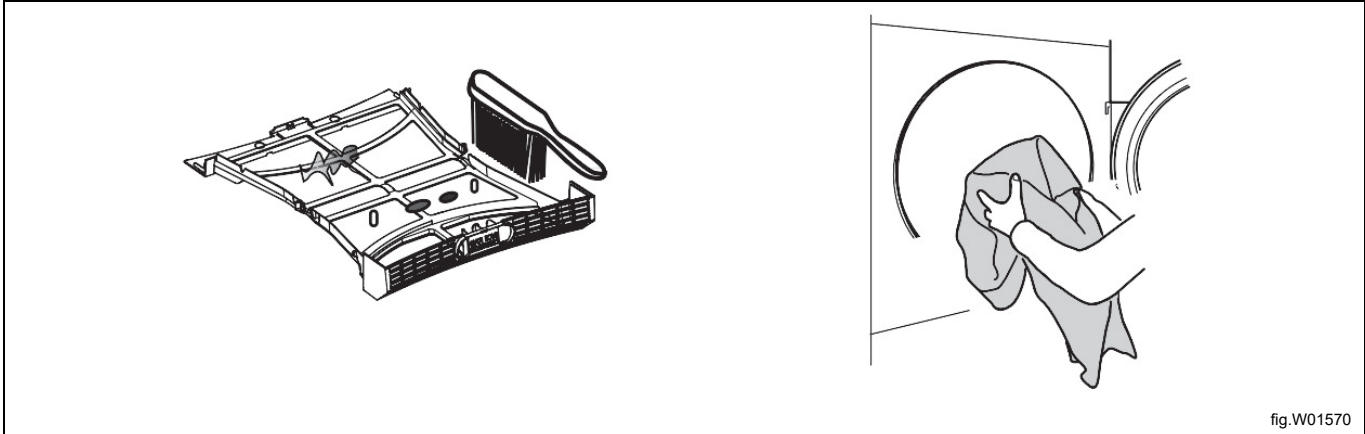

The maximum load is 12 kg.



### Warning



The appliance is not to be operated without the filter in place.

### 4.2 How to start the machine

#### 4.2.1 Select program

Select program by pressing one of the four buttons which are shown by A.

#### 4.2.2 Show program drying time on the display

There are two operation modes for the dryer to show program drying time on the display.

One is the free dry mode (OPL Mode), and the default mode of the dryer is OPL. The program operates in "Time per push mode" (OPL mode). In this mode, each time a program button is pressed, the remaining time is incremented. In any case the displayed remaining dryer time shall not be greater than the "Max drying time" for that program.

The other one is coin meter operation mode, for this mode need insert correct amount of coins to start the machine.

After start it is possible to add time for the selected program. Insert more coins to add time.

The maximum accumulated time for one cycle is 90 minutes. For example, If the program is selected for 90 minutes at the beginning, inserting more coins can not add any time, if the program is selected for 60 minutes at the beginning, the maximum increased time is 30 minutes, the total accumulated time is 90 minutes.

### 4.3 Press Start Button

Press B button to start one of the program described above in Program Description.

#### Note!

To confirm whether the gas dryer has been ignited and keep burning, you can use your hand to feel whether the temperature on the right side of the machine shell is higher than the ambient temperature after the machine has been running for three minutes. If the temperature does not change, it means that the machine is not igniting, please pause and restart the machine immediately. If the machine still does not ignite after several repeated attempts, please call the local service technician.

#### 4.4 When program has ended

**Note!**

For the best possible drying result it is important to empty the machine as soon as the program has ended. Clean the line debris filter compartment after each drying cycle for best performance.

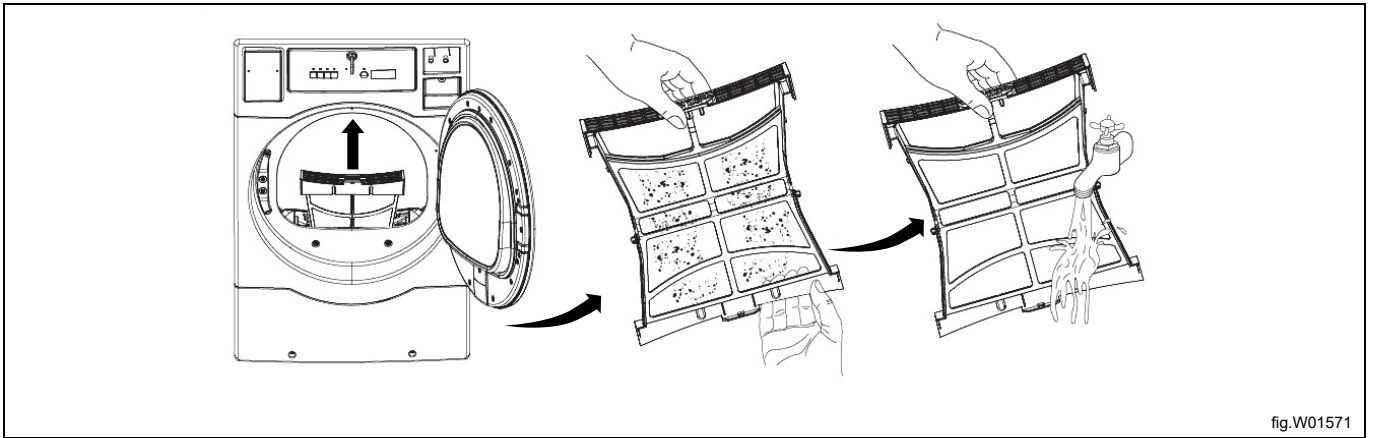

## 5 Error codes

Faults/errors in the program or machine are indicated by a numerical error code on the panel display. Some error codes (Er01, Er02, Er28) are cleared automatically when the Start button is pressed or when the door is opened. Er14 can be cleared automatically when the power cut off, but if you find the load in the drum is still wet when the PCB display Er14, you have to contact local service technician. For other error codes, a service technician must be called.

<b>Error Code</b>	<b>Cause / Action</b>
Er 00	Machine out of operation.
Er 01	Inlet air temperature limit exceeded.
Er 02	Outlet air temperature limit exceeded.
Er 03	Inlet thermistor short circuit.
Er 04	Outlet thermistor short circuit.
Er 14	Heating not working or the clothes is too dry for a long time.
Er 17	Inlet thermistor open circuit.
Er 18	Outlet thermistor open circuit.
Er 28	Inlet air temperature exceeded during previous cycle.

## 6 Maintenance

### General

It is the responsibility of the owner of the machine/the laundry manager to make sure that maintenance is periodically performed.

### Note!

**Lack of maintenance may deteriorate the performance of the machine and may cause damage to components.**

### Cleaning

A program and/or schedule should be established for periodic inspection, cleaning, and removal of lint from various areas of the dryer, as well as throughout the ductwork system. The frequency of cleaning can best be determined from experience at each location. Maximum operating efficiency is dependent upon proper airflow. The accumulation of lint can restrict this airflow.

- Clean the lint screen after each load.

### Weekly or 50 hours

- Clean lint accumulation from lint chamber, and temperature sensor NTC1 area.
- Clean the door gasket.
- Use a soft wash cloth and mild detergent to clean door.

### Every Three Months or 500 hours

- Disconnect Power.
- On removing the lint filter from the lint compartment, clean lint in the lint compartment.
- Check to clear any accumulated lint around NTC1 (See Image below).
- Clean any lint accumulation in and around the motor(s) casing opening.
- Check all the connections of gas dryer to prevent leaking gas and escaping the combustion products.

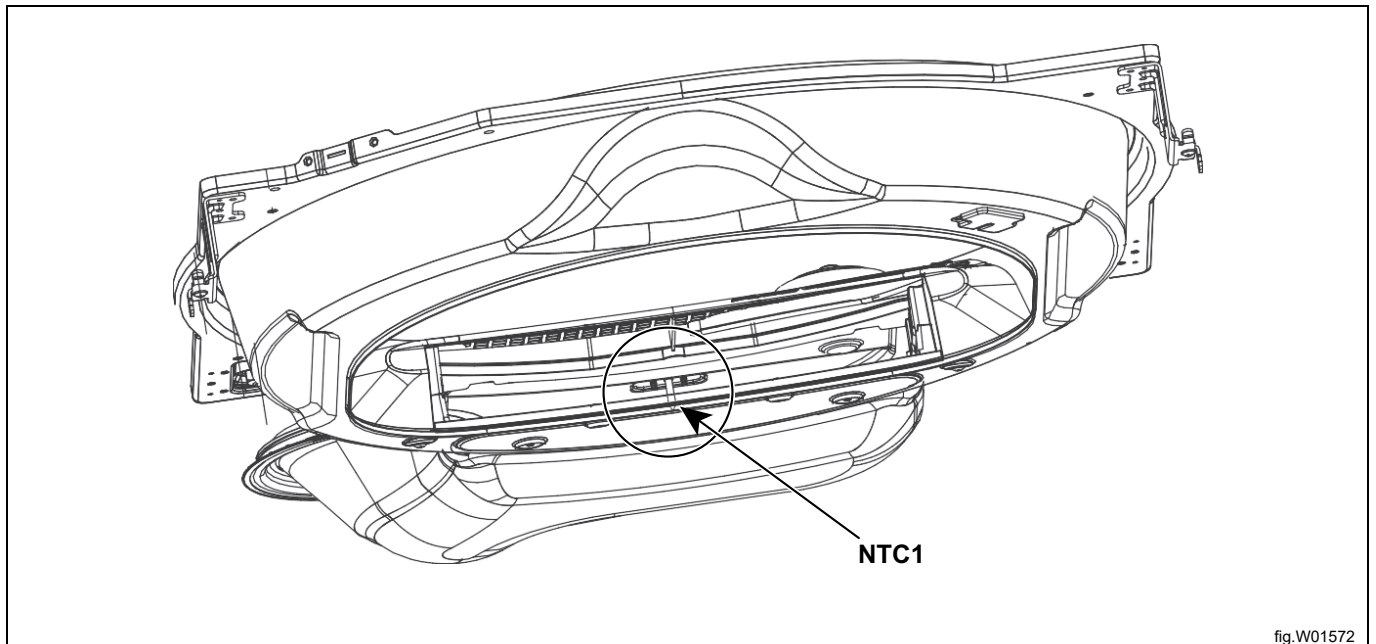

fig.W01572

**Every 6 Months or 1000 hours (Refer this service to qualified personnel)****Caution****To be carried out by qualified personnel.**

- Inspect and remove lint accumulation external exhaust ductwork and from dryer's internal exhaust ducting.
- The accumulation of lint in the exhaust ductwork can create a potential fire hazard.
- Do not obstruct the flow of combustion and ventilation air. Check back draft dampers in the exhaust ductwork. Inspect and remove any lint accumulation, which can cause the damper to bind or stick. Obstructed ducting leads to longer drying times, higher energy consumption and reduced motor life.
- If ducting is highly obstructed with lint change to a shorter service interval such as every three months.
- A back-draft damper that is sticking partially closed can result in slow drying and the shutdown of heat circuit safety switches or thermostats.
- When cleaning the dryer cabinet, avoid using cleaners with harsh abrasives. A product intended for appliance cleaning is recommended.

**Every 12 Months or 2000 hours****Caution****To be carried out by qualified personnel.**

- A competent service professional should inspect bolts, nuts, screws, setscrews, grounding.
- Belts should be examined. Cracked or seriously frayed belts should be replaced.
- Complete an operational check of controls and valves.
- Complete an operational check of all safety devices (lint switch, door switch).



## 7 Technical data

### TE1220E

Net weight	kg	70
Drum volume	litres	218
Drum diameter	mm	664
Drum depth	mm	533
Drum speed, medium load	rpm	45
Rated capacity, filling factor 1:18 (Max. load)	kg	12
Heating: Electricity ( 230V )	kW	4.84
Maximum air flow	m <sup>3</sup> /h	256
Maximum static back pressure	Pa	130
A-weighted emission sound pressure level at working stations	dB(A)	68

Level of protection against ingress of solid particles and moisture ensured by the protective cover, except where the low voltage equipment has no protection against moisture	IPX4
--	------

### TE1220G

Net weight	kg	78
Drum volume	litres	218
Drum diameter	mm	664
Drum depth	mm	533
Drum speed, medium load	rpm	45
Rated capacity, filling factor 1:18 (Max. load)	kg	12
Heating: Gas	BTU/hr	21.000
Maximum air flow	m <sup>3</sup> /h	256
Maximum static back pressure	Pa	220
Optimum static back pressure	dB(A)	152
Gas rate(Hi):G20	m <sup>3</sup> /h	0.6
Gas rate(Hi):G30	m <sup>3</sup> /h	0.17
Gas rate(Hi):G31	m <sup>3</sup> /h	0.23
Maximum sound power/pressure level at drying*	dB(A)	68/55

Level of protection against ingress of solid particles and moisture ensured by the protective cover, except where the low voltage equipment has no protection against moisture	IPX4
--	------

## 8 Disposal information

### 8.1 Disposal of appliance at end of life

Before disposing of the machine, make sure to carefully check its physical condition, and in particular any parts of the structure that can give or break during scrapping.

The machine's parts must be disposed of in a differentiated way, according to their different characteristics (e.g. metals, oils, greases, plastic, rubber, etc.).

Different regulations are in force in the various countries, therefore comply with the provisions of the laws and competent bodies in the country where scrapping takes place.

In general, the appliance must be taken to a specialised collection/scrapping centre.

Dismantle the appliance, grouping the components according to their chemical characteristics, remembering that the compressor contains lubricant oil and refrigerant fluid which can be recycled, and that the refrigerator and heat pump components are special waste assimilable with urban waste.

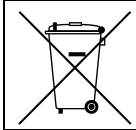

The symbol on the product indicates that this product should not be treated as domestic waste, but must be correctly disposed of in order to prevent any negative consequences for the environment and human health. For further information on the recycling of this product, contact the local dealer or agent, the Customer Care service or the local body responsible for waste disposal.



#### Note!

**When scrapping the machine, any marking, this manual and other documents concerning the appliance must be destroyed.**

### 8.2 Disposal of packing

The packing must be disposed of in compliance with the current regulations in the country where the appliance is used. All the packing materials are environmentally friendly.

They can be safely kept, recycled or burned in an appropriate waste incineration plant. Recyclable plastic parts are marked as following examples.

	Polyethylene: <ul style="list-style-type: none"> <li>• Outer wrapping</li> <li>• Instructions bag</li> </ul>
	Polypropylene: <ul style="list-style-type: none"> <li>• Straps</li> </ul>
	Polystyrene foam: <ul style="list-style-type: none"> <li>• Corner protectors</li> </ul>





Electrolux Professional AB  
341 80 Ljungby, Sweden  
[www.electroluxprofessional.com](http://www.electroluxprofessional.com)