

User manual Drying Cabinet

DC6-8HP_Q



Electrolux
PROFESSIONAL

Contents

Contents

1	Safety Precautions	5
1.1	General safety information.....	5
1.2	Symbols.....	5
2	Warranty terms and exclusions.....	6
3	Appliance layout.....	7
3.1	Components.....	7
3.2	Drying principle.....	7
3.3	Air flow.....	9
4	Operation	10
4.1	Advice and tips for using the drying cabinet with dehumidifier	10
4.2	Operation.....	10
4.3	Program description.....	10
4.4	Loads	11
5	Maintenance	12
5.1	Lint filter	12
6	Servicing	13
6.1	Dehumidifier unit identification plate	13
6.2	Cabinet identification plate.....	14
7	Troubleshooting	15
7.1	Common questions	15
7.2	Error codes	15
8	Disposal information	16
8.1	Disposal of appliance at end of life	16
8.2	Disposal of packing.....	16

The manufacturer reserves the right to make changes to design and component specifications.

1 Safety Precautions

WARNING. This appliance is intended only for drying textiles washed in water.

DO NOT MODIFY THIS APPLIANCE.

Servicing shall be carried out only by authorized personnel.

Only authorized spare parts shall be used.

When performing service or replacing parts, the power must be disconnected.

Stationary appliances not fitted with means for disconnection from the supply mains having a contact separation in all poles that provide full disconnection under overvoltage category III, means for disconnection must be incorporated in the fixed wiring in accordance with the wiring rules.

A-weighted emission sound pressure level at workstations: <70 dB

Additional requirements for the following countries: AT, BE, BG, HR, CY, CZ, DK, EE, FI, FR, DE, GR, HU, IS, IE, IT, LV, LT, LU, MT, NL, NO, PL, PT, RO, SK, SI, ES, SE, CH, TR, UK:

- This appliance can be used in public areas.
- This appliance can be used by children aged from 8 years and above and persons with reduced physical, sensory or mental capabilities or lack of experience and knowledge if they have been given supervision or instruction concerning use of the appliance in a safe way and understand the hazards involved. Children shall not play with the appliance. Cleaning and user maintenance shall not be made by children without supervision.

Additional requirements for other countries:





- This appliance is not intended for use by persons (including children) with reduced physical, sensory or mental capabilities, or lack of experience and knowledge, unless they have been given supervision or instruction concerning use of the appliance by a person responsible for their safety. Children should be supervised to ensure that they do not play with the appliance.

1.1 General safety information

Do not hose down the machine with water.

In order to prevent damage to the electronics (and other parts) that may occur as the result of condensation, the machine should be placed in room temperature for 24 hours before being used for the first time.

1.2 Symbols

	Caution
	Caution, hot surface
	Read the instructions before using the machine.
	Be careful. The drying cabinet is top heavy and can tip over easily.

2 Warranty terms and exclusions

If the purchase of this product includes warranty coverage, warranty is provided in line with local regulations and subject to the product being installed and used for the purposes as designed, and as described within the appropriate equipment documentation.

Warranty will be applicable where the customer has used only genuine spare parts and has performed maintenance in accordance with Electrolux Professional user and maintenance documentation made available in paper or electronic format.

Electrolux Professional strongly recommends using Electrolux Professional approved cleaning, rinse and descaling agents to obtain optimal results and maintain product efficiency over time.

The Electrolux Professional warranty does not cover:

- service trips cost to deliver and pick up the product;
- installation;
- training on how to use/operate;
- replacement (and/or supply) of wear and tear parts unless resulting from defects in materials or workmanship reported within one (1) week from the failure;
- correction of external wiring;
- correction of unauthorized repairs as well as any damages, failures and inefficiencies caused by and/or resulting from:
 - insufficient and/or abnormal capacity of the electrical systems (current/voltage/frequency, including spikes and/or outages);
 - inadequate or interrupted water supply, steam, air, gas (including impurities and/or other that does not comply with the technical requirements for each appliance);
 - plumbing parts, components or consumable cleaning products that are not approved by the manufacturer;
 - customer's negligence, misuse, abuse and/or non-compliance with the use and care instructions detailed within the appropriate equipment documentation;
 - improper or poor: installation, repair, maintenance (including tampering, modifications and repairs carried out by third parties not authorized third parties) and modification of safety systems;
 - Use of non-original components (e.g.: consumables, wear and tear, or spare parts);
 - environment conditions provoking thermal (e.g. overheating/freezing) or chemical (e.g. corrosion/oxidation) stress;
 - foreign objects placed in- or connected to- the product;
 - accidents or force majeure;
 - transportation and handling, including scratches, dents, chips, and/or other damage to the finish of the product, unless such damage results from defects in materials or workmanship and is reported within one (1) week of delivery unless otherwise agreed;
- product with original serial numbers that have been removed, altered or cannot be readily determined;
- replacement of light bulbs, filters or any consumable parts;
- any accessories and software not approved or specified by Electrolux Professional.

Warranty does not include scheduled maintenance activities (including the parts required for it) or the supply of cleaning agents unless specifically covered within any local agreement, subject to local terms and conditions.

Check on Electrolux Professional website the list of authorized customer care.

3 Appliance layout

3.1 Components

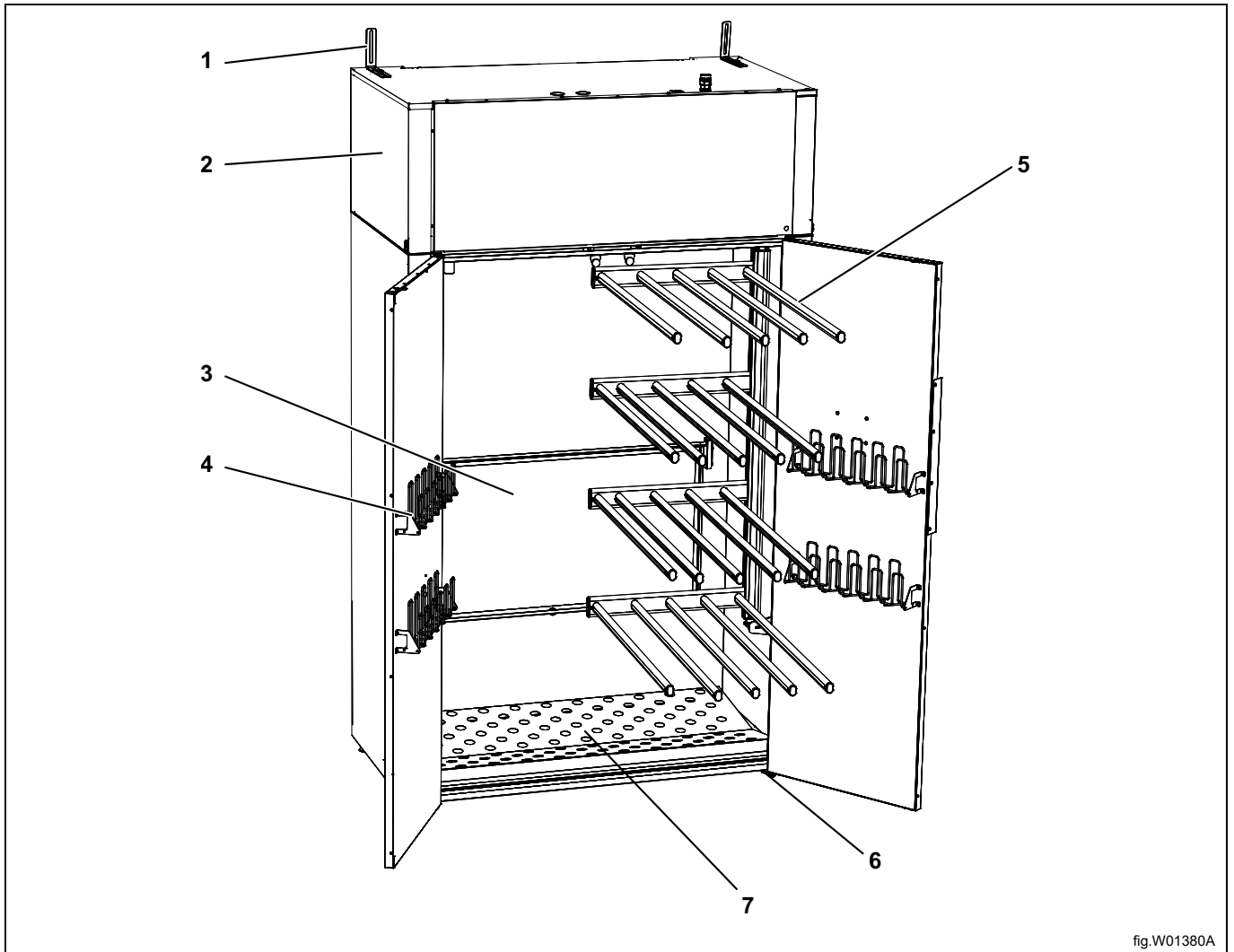

fig.W01380A

The figure shows the cabinet in the left version

1	Wall bracket
2	Heat pump component
3	Folding flat drying frame
4	Glove hangers
5	Expandable hanger. The lower hanger section contains curtain coils that can be used to fasten items.
6	Adjustable feet
7	Shoe rack

3.2 Drying principle

The drying cabinet works according to the principle of heat pump with dehumidifier unit instead of conventional hot air unit. This dries the garments at a lower heat and with significantly lower energy consumption.

The cabinet is a completely closed system. No exhaust air connection is required. The moisture is condensed during the process, and the water formed is directed to the drain via a hose.

In addition, the fan is so powerful that it makes the garments sway, making the drying process even more efficient.

Conventional drying cabinet

Energy consumption approx. 0.7 kWh/kg of laundry

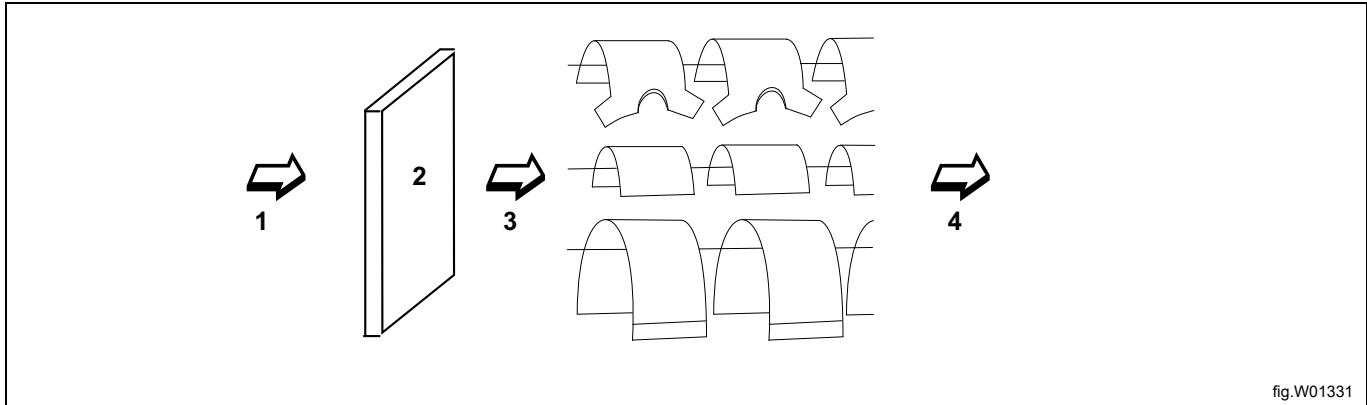

fig.W01331

1	Air from room
2	Heating battery
3	Hot air
4	Hot, humid air that is led away

Drying cabinet with heat pump

Energy consumption approx. 0.35 kWh/kg of laundry

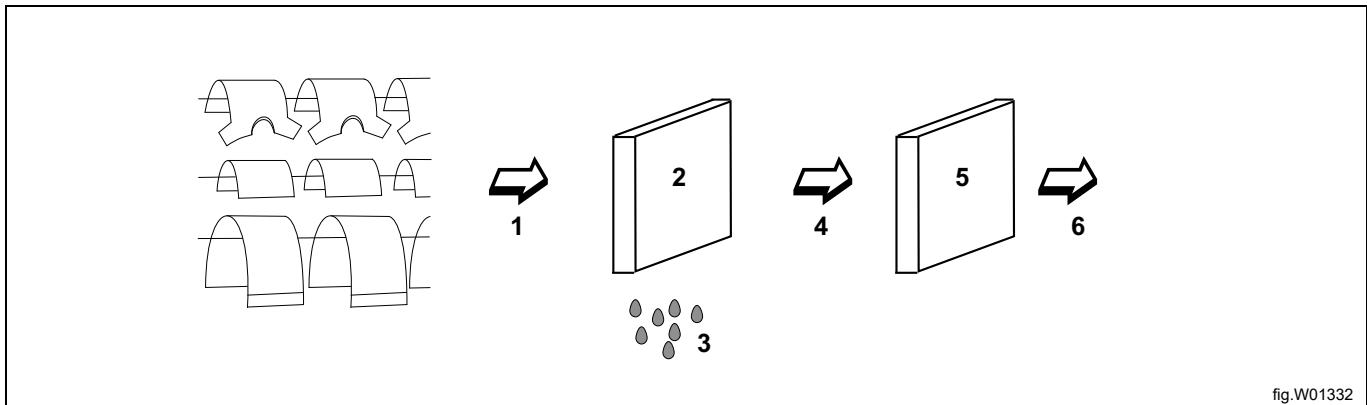

fig.W01332

1	Hot, humid air
2	Cooling battery
3	Condensation / water drops. Diverted to floor drain
4	Cooled air
5	Heating battery
6	Heated, dry air that is directed back into the drying cabinet. The air is at a lower temperature than in a conventional drying cabinet

3.3 Air flow

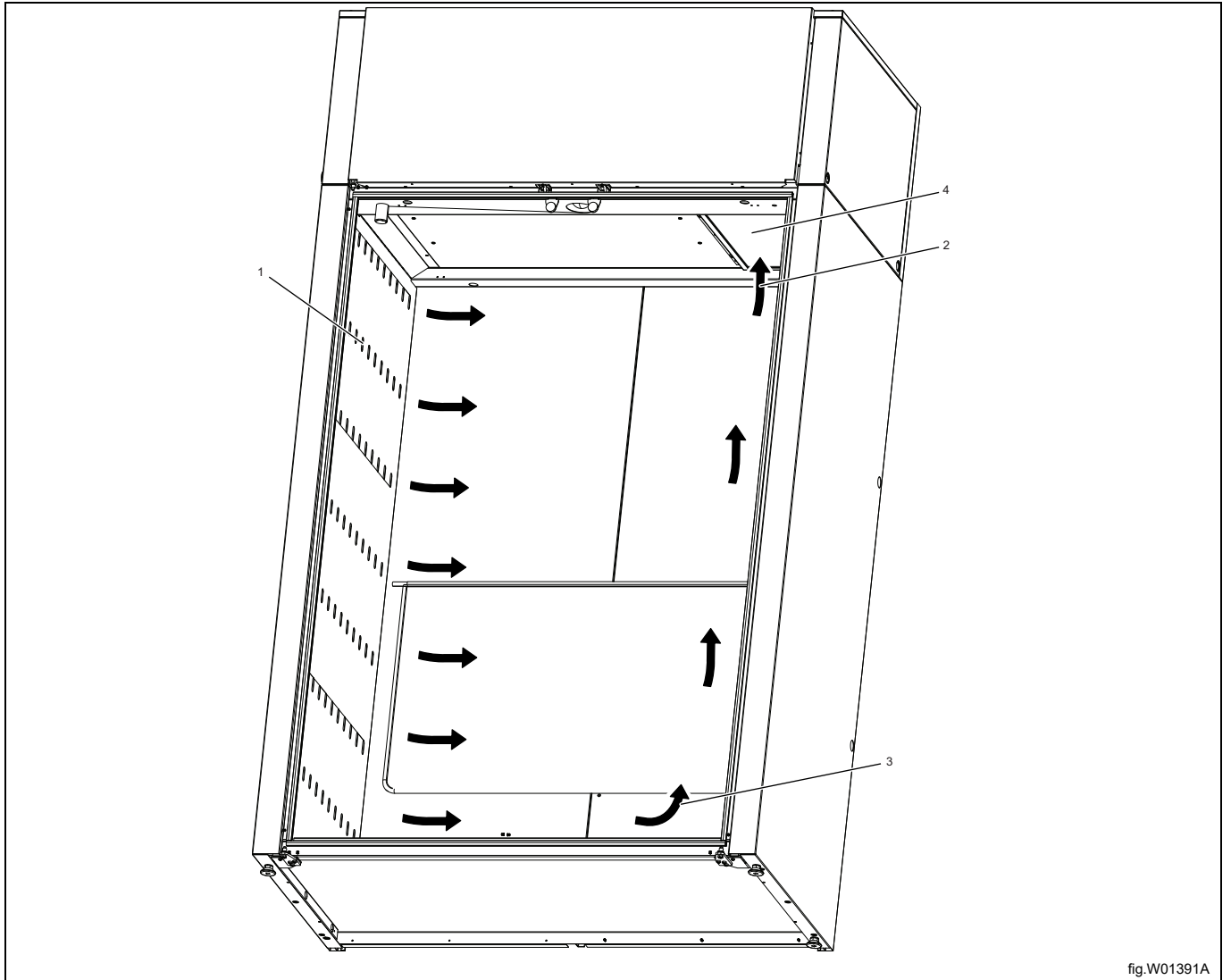

fig.W01391A

1	Inlet for hot, dry air
2	Outlet for humid air. A lint filter is located in front of the air intake.
3	Circulating hot air
4	Lint filter

4 Operation

4.1 Advice and tips for using the drying cabinet with dehumidifier

- Always run the laundry through the spin cycle
- Do not hang the garments too close together as it will prolong the drying time
- The doors must always be closed during the drying process
- The temperature in a dehumidifying cabinet is lower
- It is not heat that dries the laundry

4.2 Operation

Expand the hanger unit and hang the laundry evenly over the hangers.

Close the hanger unit and close the doors.

Select a drying program (A). Drying will start when the program button is pressed. The symbol (bar) on the left side of the display (B) indicates that the drying process is in progress.

The drying cabinet will stop automatically when the laundry is dry.

When the textiles are dry, the drying process switches to a cool-down period that ends automatically after 3 minutes. During the cool-down period, the text "COOL" is shown on the display.

The display shows the text "END" (flashing).

To cancel the drying cycle, press and hold the Stop button (C) for at least 3 seconds. If the Stop button is released before 3 seconds have elapsed, the drying process will not stop.

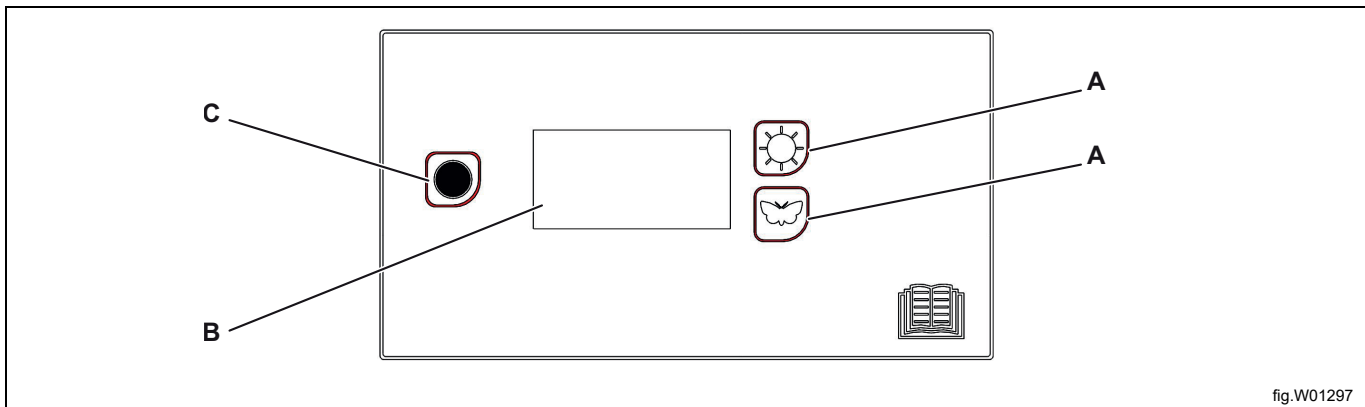
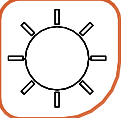



fig.W01297

4.3 Program description

	Normal drying
	Gentle drying of sensitive material

4.4 Loads

For optimum energy efficient drying, operate with a full load and do not open either door until the appliance has stopped. If the door is opened during drying, the drying time will increase.

The drying cabinet has an expandable hanger unit. The lower section contains curtain coils that can be used to fasten items. Hanging the laundry according to the following instructions will result in the most efficient drying result.

- Hang the items in the drying cabinet according to how much room they require and not according to their weight.
- Do not lie the garments flat over the upper part of the hanger unit.
- Hang gloves, caps, scarves and the like on the hanger bars on the inside of the cabinet.
- Do not overload the drying cabinet. The laundry will become creased and dry unevenly. Leave some space between the items if possible. To avoid the transferring of colors, make sure materials are not touching each other.
- Avoid drying thick items at the same time as lighter items as they hold more moisture and have completely different drying times. If so, remove the lighter items when they are dry to reduce the drying time for the thick items that are left.
- Do not hang knitted items. These will stretch unnecessarily as they are heavy when wet. Follow the instructions on the care label of the garment as far as possible.



Do not dry any garment or the like that has been treated with gasoline or another volatile and flammable agent. This could cause an explosive gas mixture to form.

5 Maintenance

It is the responsibility of the owner of the appliance/the laundry manager to make sure that maintenance is performed regularly.

Note!

Lack of maintenance may deteriorate the performance of the appliance and may cause damage to components.

The cabinet's walls can be cleaned using a damp cloth and a mild soap solution.

5.1 Lint filter

Brush the lint filter clean with the provided brush.

The lint filter shall be cleaned each time the drying cabinet has been used.

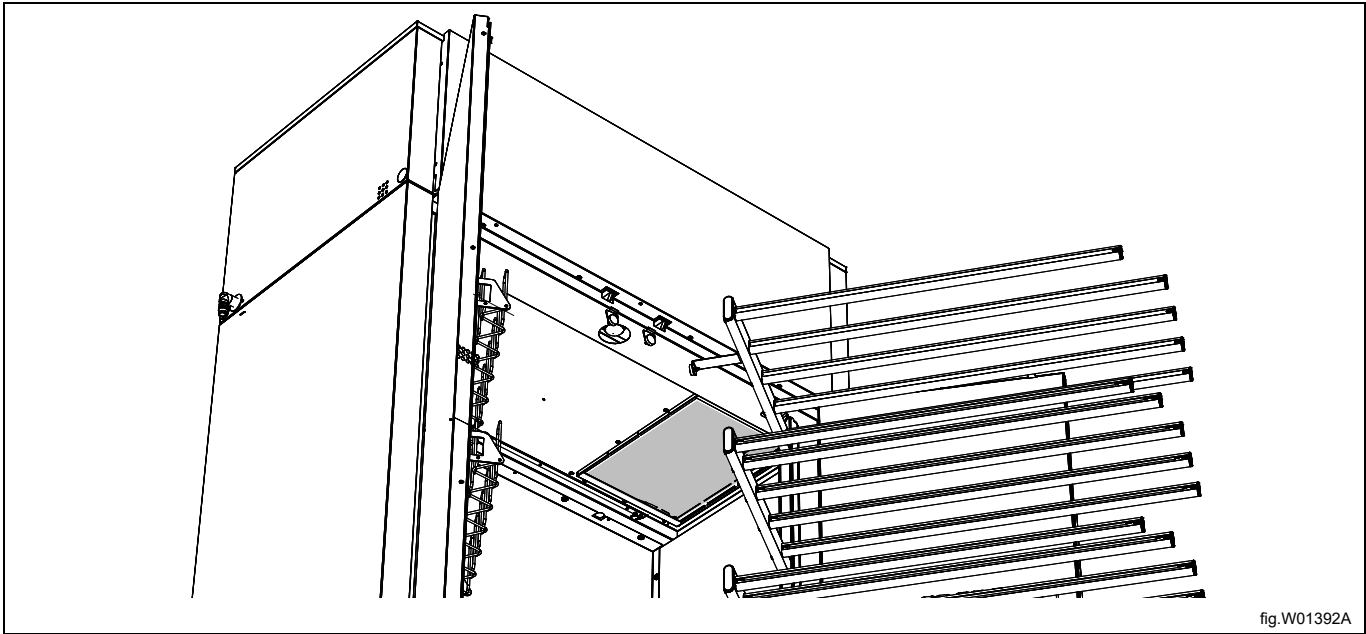

fig.W01392A

The lint filter must be replaced when necessary.

If the lint filter is exposed to an abnormal amount of lint and dust, it must be replaced more often.

Failure to follow these instructions may result in unnecessary wear on the heat pump, which could shorten the appliance's service life.

Failure to follow these instructions will also void the warranty.

The lint filter can be purchased from your nearest Electrolux Professional dealer or service partner.

6 Servicing

Before contacting the service department, you should find out the name, article number and serial number of the drying cabinet. This is found on the identification plate.

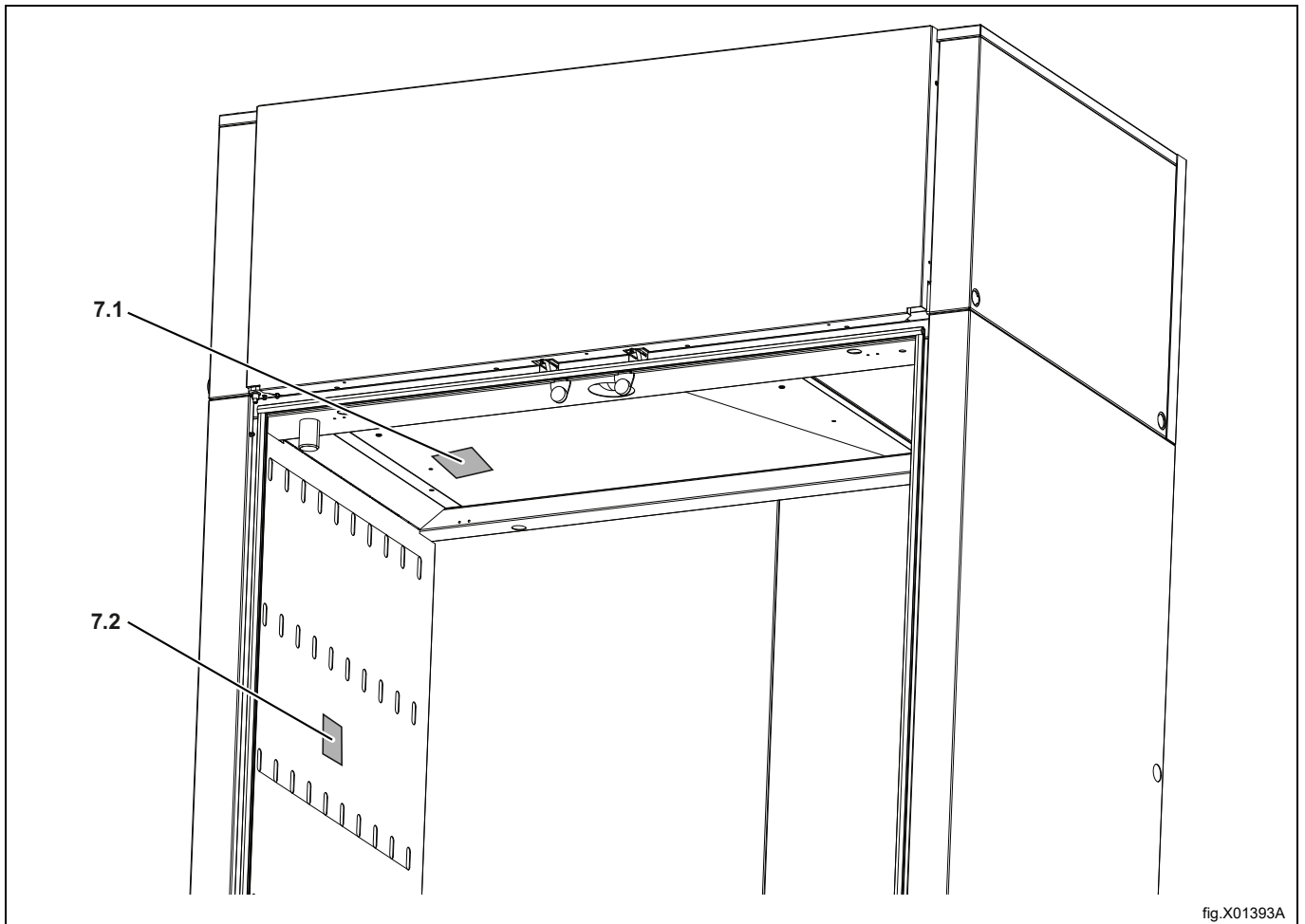

fig.X01393A

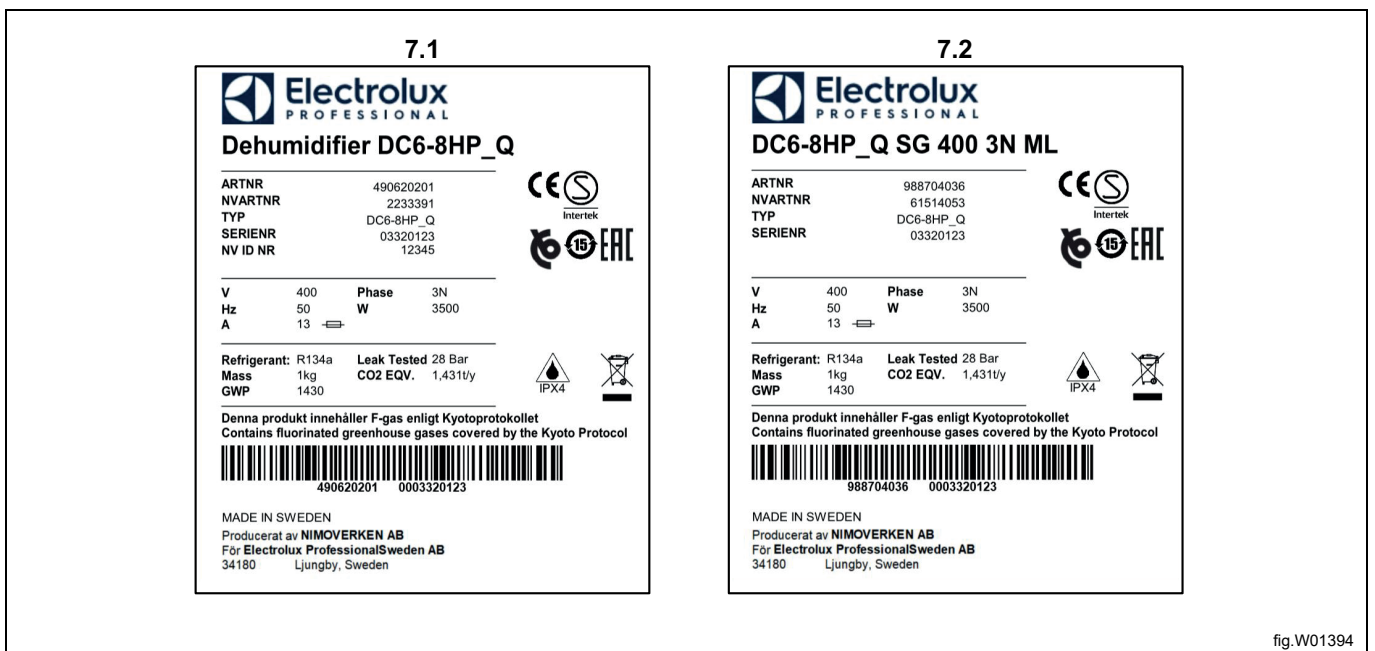

fig.W01394

6.1 Dehumidifier unit identification plate

The identification plate is located in the ceiling inside the cabinet.

6.2 Cabinet identification plate

This identification plate applies in combination with the identification in the upper part.

7 Troubleshooting

7.1 Common questions

Problem	What you can do
The drying cabinet does not work	<ol style="list-style-type: none"> 1. Check the mains connection and that the cabinet is receiving power. 2. Check that no fuse has been tripped. 3. Did you press the program selection button? 4. Check that the doors are closed.
Drying takes a long time	<ol style="list-style-type: none"> 1. Clean the fine filter (must be done after each drying session). 2. Check that the right program was selected for the type of garments in question. 3. Check to ensure the garments are not extremely wet (poorly centrifuged). 4. Check that there is not too much laundry in the cabinet.
The laundry does not get dry	<ol style="list-style-type: none"> 1. Check that the right program was selected for the type of garments in question. 2. Check that there is not too much laundry in the cabinet. 3. The software that controls the drying process requires adjustment. Contact a service technician.

7.2 Error codes

No.	Name	Description / Action
ER 03	Moisture sensor error	Contact Service
ER 04	Max time for drying process exceeded	Contact Service
ER 12	Communication timeout	Contact Service

The Stop button must be held depressed for 5 seconds to reset an error code.

8 Disposal information

8.1 Disposal of appliance at end of life

Before disposing of the machine, make sure to carefully check its physical condition, and in particular any parts of the structure that can give or break during scrapping.

The machine's parts must be disposed of in a differentiated way, according to their different characteristics (e.g. metals, oils, greases, plastic, rubber, etc.).

Different regulations are in force in the various countries, therefore comply with the provisions of the laws and competent bodies in the country where scrapping takes place.

In general, the appliance must be taken to a specialised collection/scrapping centre.

Dismantle the appliance, grouping the components according to their chemical characteristics, remembering that the compressor contains lubricant oil and refrigerant fluid which can be recycled, and that the refrigerator and heat pump components are special waste assimilable with urban waste.

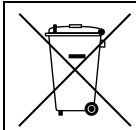

The symbol on the product indicates that this product should not be treated as domestic waste, but must be correctly disposed of in order to prevent any negative consequences for the environment and human health. For further information on the recycling of this product, contact the local dealer or agent, the Customer Care service or the local body responsible for waste disposal.



Note!

When scrapping the machine, any marking, this manual and other documents concerning the appliance must be destroyed.

8.2 Disposal of packing

The packing must be disposed of in compliance with the current regulations in the country where the appliance is used. All the packing materials are environmentally friendly.

They can be safely kept, recycled or burned in an appropriate waste incineration plant. Recyclable plastic parts are marked as following examples.

	Polyethylene: <ul style="list-style-type: none"> • Outer wrapping • Instructions bag
	Polypropylene: <ul style="list-style-type: none"> • Straps
	Polystyrene foam: <ul style="list-style-type: none"> • Corner protectors



Electrolux Professional AB
341 80 Ljungby, Sweden
www.electroluxprofessional.com