

User manual Tumble dryer

TD6–20LAC
Type N2...



Electrolux
PROFESSIONAL

Contents

Contents

1	Safety Precautions	5
1.1	Additional safety precautions for gas heated tumble dryer	7
1.2	General information	7
1.3	Commercial use only	7
1.4	Copyright	7
1.5	Ergonomics certification	7
1.6	Symbols	8
2	Warranty terms and exclusions	9
3	Operating panel	10
4	Program description	11
4.1	Lagoon programs	11
4.2	General programs	12
4.3	Automatic fan control	12
5	Handling	13
5.1	Load	13
5.2	How to start the machine	14
5.3	Additional functions	14
5.4	When program has ended	15
6	Error codes	17
7	Maintenance	17
7.1	General	17
7.2	Time for maintenance	17
7.3	Every day	18
7.4	Machines with heat pump	19
7.4.1	Second lint filter	19
8	Disposal information	20
8.1	Disposal of appliance at end of life	20
8.2	Disposal of packing	20

The manufacturer reserves the right to make changes to design and component specifications.

1 Safety Precautions

- Servicing shall be carried out only by authorized personnel.
- Only authorized spare parts, accessories and consumables shall be used.
- The machine is not to be used if industrial chemicals have been used for cleaning.
- Do not dry unwashed items in the machine.
- Items that have been soiled with substances such as cooking oil, acetone, alcohol, petrol, kerosene, spot removers, turpentine, waxes and wax removers should be washed in hot water with an extra amount of detergent before being dried in the machine.
- Items such as foam rubber (latex foam), shower caps, waterproof textiles, rubber backed articles and clothes or pillows fitted with foam rubber pads should not be dried in the machine.
- Fabric softeners or similar products should be used as specified by the fabric softener instructions.
- The final part of a drying cycle occurs without heat (cool down cycle) to ensure that the items are left at a temperature that ensures that the items will not be damaged.
- Remove all objects from pockets such as lighters and matches.
- **WARNING.** Never stop the machine before the end of the drying cycle unless all items are quickly removed and spread out so that the heat is dissipated.
- Adequate ventilation has to be provided to avoid the back flow of gases into the room for appliances burning other fuels, including open fires.
- Exhaust air must not be discharged into a flue which is used for exhausting fumes from appliances burning gas or other fuels.
- The machine must not be installed behind a lockable door, a sliding door or a door with a hinge on the opposite side to that of the machine in such a way that a full opening of the machine is restricted.
- If the machine has a lint trap this has to be cleaned frequently.
- The lint must not be accumulated around the machine.
- **DO NOT MODIFY THIS APPLIANCE.**
- When performing service or replacing parts, the power must be disconnected.
- When the power is disconnected, the operator must see that the machine is disconnected (that the plug is removed and remains removed) from any point to which he has access. If this is not possible, due to the construction or installation of the machine, a disconnection with a locking system in the isolated position shall be provided.
- In accordance with the wiring rules: mount a multi-pole switch prior to the machine to facilitate installation and service operations.
- Stationary appliances not fitted with means for disconnection from the supply mains having a contact separation in all poles that provide full disconnection under overvoltage category III, means for disconnection must be incorporated in the fixed wiring in accordance with the wiring rules.
- **WARNING:** The appliance must not be supplied through an external switching device, such as a timer, or connected to a circuit that is regularly switched on and off by a utility.
- If different rated voltages or different rated frequencies (separated by a /) are stated at the machine data plate, instructions for adjusting the appliance for operation at the required rated voltage or rated frequency are stated in the installation manual.
- The openings in the base, shall not be obstructed by a carpet.

- Oil-affected items can ignite spontaneously, especially when exposed to heat sources such as in a tumble dryer. The items become warm, causing an oxidation reaction in the oil. Oxidation creates heat. If the heat cannot escape, the items can become hot enough to catch fire. Piling, stacking or storing oil-affected items can prevent heat from escaping and so create a fire hazard.
- If it is unavoidable that fabrics that contain vegetable or cooking oil or have been contaminated by hair care products be placed in a tumble dryer they should first be washed in hot water with extra detergent – this will reduce, but not eliminate, the hazard.
- Maximum mass of dry cloth: 20 kg.
- A-weighted emission sound pressure level at working stations: 70 dB(A).
- Additional requirements for the following countries; AT, BE, BG, HR, CY, CZ, DK, EE, FI, FR, DE, GR, HU, IS, IE, IT, LV, LT, LU, MT, NL, NO, PL, PT, RO, SK, SI, ES, SE, CH, TR, UK:
 - The appliance can be used in public areas.
 - This appliance can be used by children aged from 8 years and above and persons with reduced physical, sensory or mental capabilities or lack of experience and knowledge if they have been given supervision or instruction concerning use of the appliance in a safe way and understand the hazards involved. Children shall not play with the appliance. Cleaning and user maintenance shall not be made by children without supervision.
- Additional requirements for other countries:
 - This appliance is not intended for use by persons (including children) with reduced physical, sensory or mental capabilities, or lack of experience and knowledge, unless they have been given supervision or instruction concerning use of the appliance by a person responsible for their safety. Children should be supervised to ensure that they do not play with the appliance.

1.1 Additional safety precautions for gas heated tumble dryer

- Before installation, check that the local distribution conditions, nature of gas and pressure and the adjustment of the appliance are compatible.
- The machine is not to be installed in rooms containing cleaning machines with perchloroethylene, TRICHLOROETHYLENE or CHLOROFLUOROCONTAINING HYDROCARBONS as cleaning agents.
- NOTE: it is pointed out that the connection and commissioning of appliances complying with this standard are subject to observance of the installation regulations in force in the countries where these appliances are marketed.
- Connection to the appliance shall be made with a flexible hose suitable for the appliance category in accordance with national installation regulations of the country of destination and that in case of doubt the installer shall contact the supplier.
- The appliance should be installed on non-flammable materials for the floor, worktop and/or wall close to the appliance if required.
- If you can smell gas:
 - Do not switch on any equipment
 - Do not use electrical switches
 - Do not use telephones in the building
 - Evacuate the room, building or area
 - Contact the person responsible for the machine

1.2 General information

Conditions for storage and transportation of the appliance should fulfil a temperature between -20°C / + 70°C and max Humidity of 95% RH.

In order to prevent damage to the electronics (and other parts) that may occur as the result of condensation, the machine should be placed in room temperature for 24 hours before being used for the first time.

Electric power supply should follow:

- Max range for each country rated voltage: -15% / +10%.
- Max range for each country rated frequency: ± 3 Hz.
- Dips/Interruption: 5 Dips/day (100% voltage lost, with 3-4 minutes duration).

A stable power supply is always the best. Fluctuations gives stress and additional load on all electric and electronic components.

1.3 Commercial use only

The machine/machines covered by this manual is/are made for commercial and industrial use only.

1.4 Copyright

This manual is intended solely for consultation by the operator and can only be given to third parties with the permission of Electrolux Professional AB company.

1.5 Ergonomics certification

The human body is designed for movement and activity but physical stress injuries as a result of static and repetitive movements or unfavorable working postures may occur.

The ergonomic features of your product, the ones which may influence your physical and cognitive interaction with it, have been assessed and certified.

A product which exhibits ergonomic features, in fact, shall fulfil specific ergonomic requirements, belonging to three different areas: Polytechnic, Biomedical and Psychosocial (usability and satisfaction).

For each of these areas, specific tests with real users have been performed. The product was therefore compliant with the ergonomic acceptability criteria requested by the standards.







In case several machines are managed by the same operator the repetitive movements will increase and as a consequence of this the related biomechanical risk will increase exponentially.

The possible postural risks are the interaction with the user interface, display and buttons.

Follow the below recommendations to avoid, as much as possible, operators acquiring bodily injury.

- Make sure there are suitable trolleys or baskets for loading, unloading and transportation.
- Organize job rotation in the working place in the case several machines are managed by the same operator.

1.6 Symbols

	Caution
	Caution, hot surface
	Caution, high voltage
	Warning, risk of fire / flammable material
	Danger, crush hazard
	Read the instructions before using the machine

2 Warranty terms and exclusions

If the purchase of this product includes warranty coverage, warranty is provided in line with local regulations and subject to the product being installed and used for the purposes as designed, and as described within the appropriate equipment documentation.

Warranty will be applicable where the customer has used only genuine spare parts and has performed maintenance in accordance with Electrolux Professional user and maintenance documentation made available in paper or electronic format.

Electrolux Professional strongly recommends using Electrolux Professional approved cleaning, rinse and descaling agents to obtain optimal results and maintain product efficiency over time.

The Electrolux Professional warranty does not cover:

- service trips cost to deliver and pick up the product;
- installation;
- training on how to use/operate;
- replacement (and/or supply) of wear and tear parts unless resulting from defects in materials or workmanship reported within one (1) week from the failure;
- correction of external wiring;
- correction of unauthorized repairs as well as any damages, failures and inefficiencies caused by and/or resulting from;
 - insufficient and/or abnormal capacity of the electrical systems (current/voltage/frequency, including spikes and/or outages);
 - inadequate or interrupted water supply, steam, air, gas (including impurities and/or other that does not comply with the technical requirements for each appliance);
 - plumbing parts, components or consumable cleaning products that are not approved by the manufacturer;
 - customer's negligence, misuse, abuse and/or non-compliance with the use and care instructions detailed within the appropriate equipment documentation;
 - improper or poor: installation, repair, maintenance (including tampering, modifications and repairs carried out by third parties not authorized third parties) and modification of safety systems;
 - Use of non-original components (e.g.: consumables, wear and tear, or spare parts);
 - environment conditions provoking thermal (e.g. overheating/freezing) or chemical (e.g. corrosion/oxidation) stress;
 - foreign objects placed in- or connected to- the product;
 - accidents or force majeure;
 - transportation and handling, including scratches, dents, chips, and/or other damage to the finish of the product, unless such damage results from defects in materials or workmanship and is reported within one (1) week of delivery unless otherwise agreed;
- product with original serial numbers that have been removed, altered or cannot be readily determined;
- replacement of light bulbs, filters or any consumable parts;
- any accessories and software not approved or specified by Electrolux Professional.

Warranty does not include scheduled maintenance activities (including the parts required for it) or the supply of cleaning agents unless specifically covered within any local agreement, subject to local terms and conditions.

Check on Electrolux Professional website the list of authorized customer care.

3 Operating panel

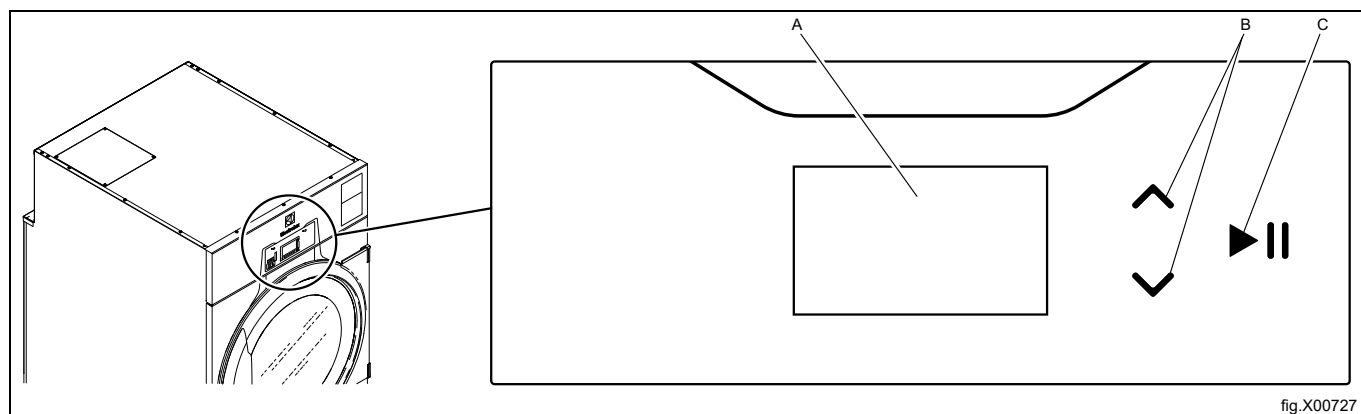

fig.X00727

A	Display
B	Up- and down arrows that are used to scroll up and down through the menus on the display.
C	Start- and pause button

4 Program description











There are two types of programs, automatic programs and time programs.

Automatic programs has moisture detection and will stop when selected dryness is achieved.

Time programs has no moisture detection and will stop when the preset or selected time has ended.











4.1 Lagoon programs

The following table shows some examples of available programs and a short description of those:

Automatic programs	Description
WOOL HIGH 	Wool coat, jumper, heavy suit jacket, trousers. The program will stop when set dryness is achieved.
WOOL MEDIUM 	Wool suit jacket, wool skirt. The program will stop when set dryness is achieved.
SILK 	Silk dress, viscose dress. The program will stop when set dryness is achieved.
SYNTHETIC MIX MEDIUM 	Cotton suit, linen suit, rain coat. Mixed fibre with cotton The program will stop when set dryness is achieved.
SYNTHETIC MIX LOW 	Synthetic fur. Mixed fibre with viscose. Mixed fibre with polyester. The program will stop when set dryness is achieved.
CURTAINS 	Curtains, ties in the net. The program will stop when set dryness is achieved.
GENTLE 40 	Gentle program for sensitive textiles. The program will stop when set dryness is achieved.
Time programs	Description
NO HEATING 	Airing bedspreads, duvets and bedclothes. Different drying times can be selected. The program will stop when the time is up.
LOW 	Synthetic (example of synthetic fabrics: polyester, polyamide, polyacrylic and elasthan), viscose, polycotton and delicate fabrics. Different drying times can be selected. The program will stop when the time is up.
HIGH 	Cotton and terry. Different drying times can be selected. The program will stop when the time is up.

4.2 General programs

The following table shows some examples of available programs and a short description of those:

Hidden programs	Description
COTTON EXTRA DRY 	Denim and terry. The program will stop when set dryness is achieved.
COTTON CARE 	Cotton and terry. The program will stop when set dryness is achieved.
COTTON IRON DRY 	Cotton. The program will stop when set dryness is achieved.
WOOL LAGOON WOOLMARK 	Program to process wool garments according to Lagoon Woolmark. Fixed drying time. The program will stop when the time is up.
POLY COTTON DRY 	Viscose and polycotton. The program will stop when set dryness is achieved.
SYNTHETICS DRY 	Synthetic (example of synthetic fabrics: polyester, polyamide, polyacrylic and elasthan), viscose, polycotton and delicate fabrics. The program will stop when set dryness is achieved.
SYNTHETICS IRON DRY 	Synthetic (example of synthetic fabrics: polyester, polyamide, polyacrylic and elasthan), viscose, polycotton and delicate fabrics. The program will stop when set dryness is achieved.
COTTON DENIM 	Denim. The program will stop when set dryness is achieved.
COTTON TERRY 	Terry. The program will stop when set dryness is achieved.
COTTON SHEETS 	Sheets. The program will stop when set dryness is achieved.
MICROFIBRE 	Microfibre. The program will stop when set dryness is achieved.

4.3 Automatic fan control

If the machine is equipped with automatic fan control the machine is able to self-optimize the air flow according to installation- and running conditions.

If machines with automatic fan control stands next to machines without automatic fan control they will behave and sound completely different.

5 Handling

5.1 Load

Note!

Remove all objects from pockets and make sure there are no metal objects such as screws, pins etc. left. Metal objects might cause damage to the drum.

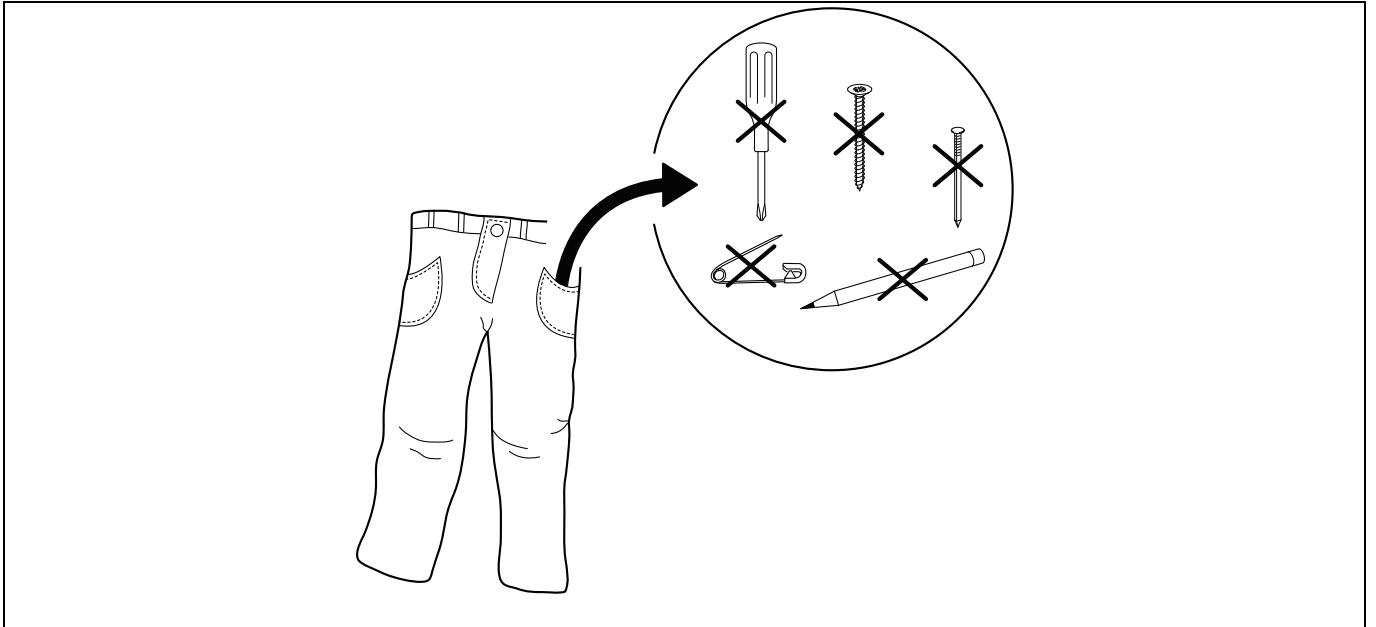

Make sure the filter is clean.

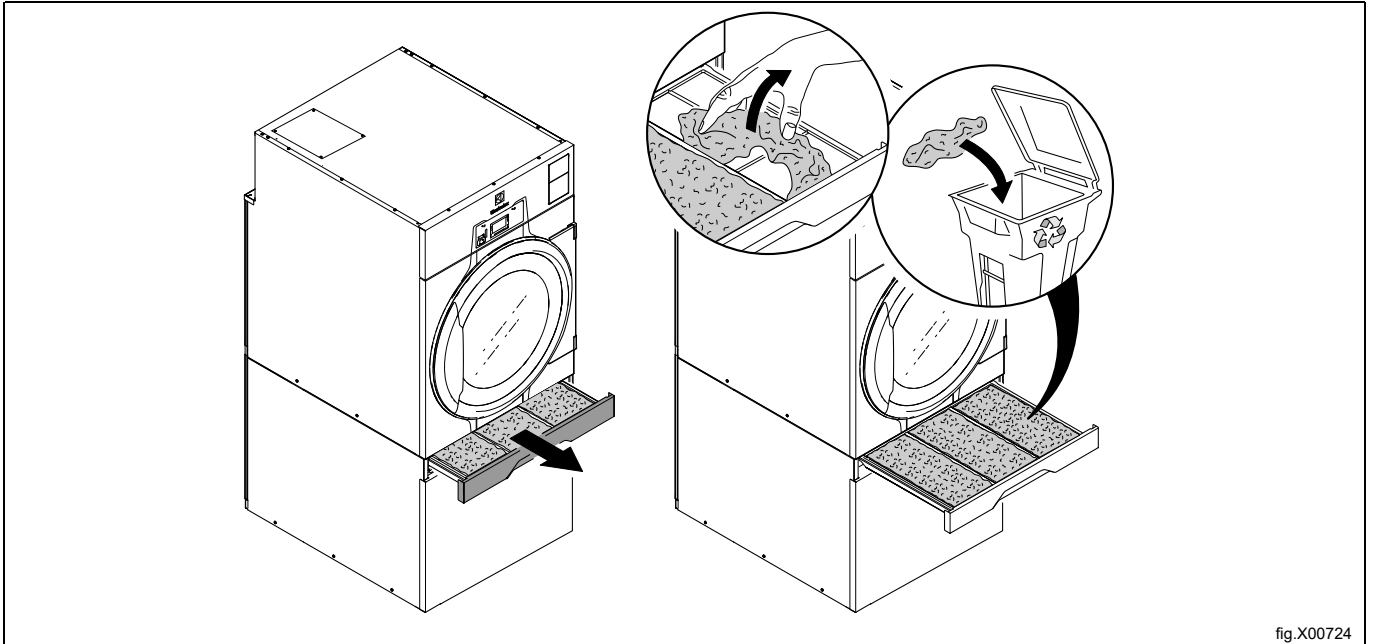

fig.X00724

Load the goods into the machine and close the door.
The recommended maximum load is 20 kg.

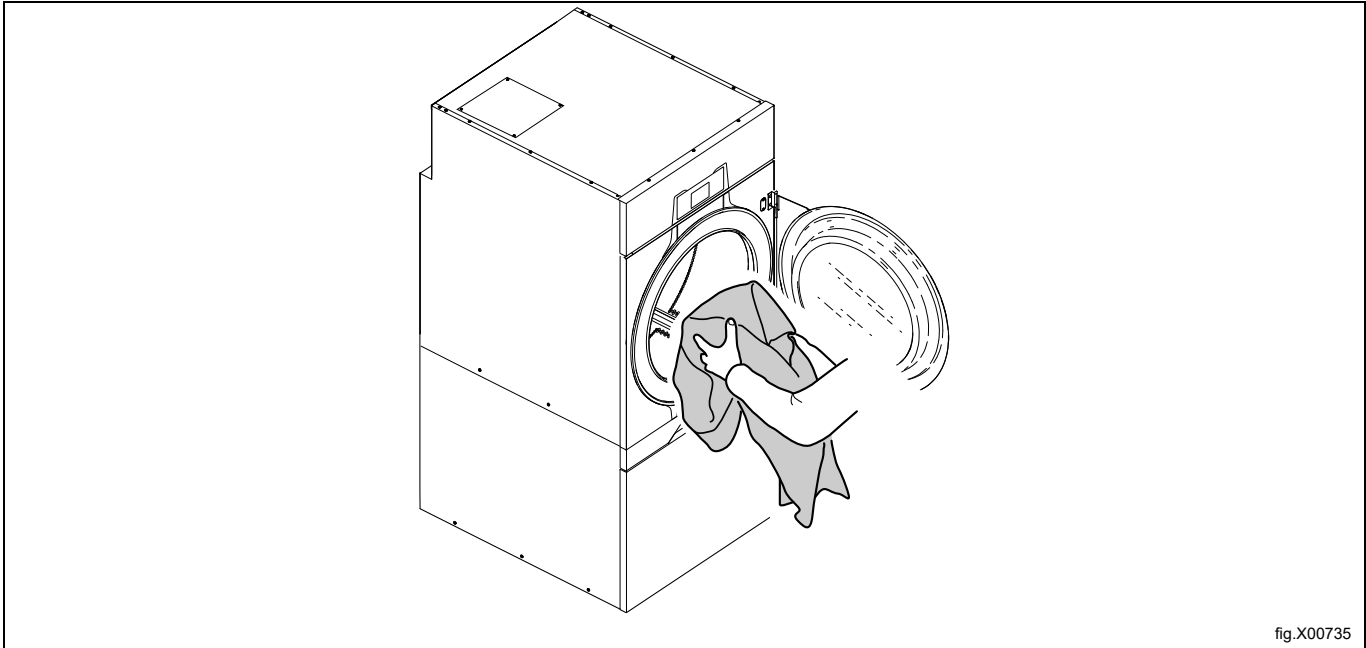

fig.X00735

5.2 How to start the machine

Automatic programs

Select program with the up- and down arrows.

Start the machine by pressing ►|| .

Time programs

Select program with the up- and down arrows.

Start the machine by pressing ►|| .

After start it is possible to change the time for the selected program:

- Increase or decrease the time with the up- and down arrows,
 ▲ increases the time and ▼ decreases the time.
- Press ►|| to start again.

5.3 Additional functions

There is a menu with additional functions available for selection after start. When pressing ►|| the menu will appear on the display.

Select from the menu with the up- and down arrows and press ►|| to activate.

Note!

Some of the functions may not be available or active on your machine.

Pause

It is possible to pause an ongoing program.

Select PAUSE and activate.

For some machines it is also possible to pause directly when pressing ►|| .

When pressing ►|| again the program will continue.

End a program

It is possible to end a program after start.

Select **END PROGRAM** and activate.

When pressing **▶||** the program will be ended.

Status

Select **STATUS MENU** and activate.

The status menu shows the status for inlet air temp, outlet air temp, RMC and if the heat is on or off in the machine.

Change drum speed (only on machines with DCS)

Select **CHANGE DRUM SPEED** and activate.

Change the drum speed with the up- and down arrows and press **▶||** to activate.

Use the following table as a guide to set the optimum drum speed.

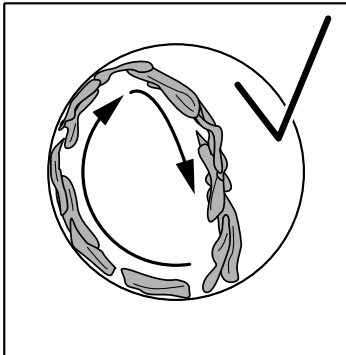
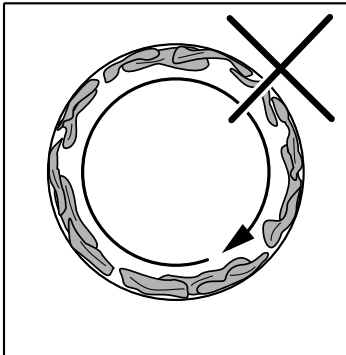
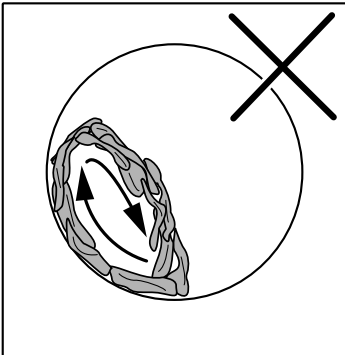
Optimum drum speed	Too fast drum speed	Too slow drum speed
		

The table of optimum drum speed is a general recommendation. Optimal drum speed and how the load should be distributed in the drum can vary depending on type of load and drying process, the table should thus be seen as general load distribution recommendation.

5.4 When program has ended

Note!

For the best possible drying result it is important to empty the machine as soon as the program has ended.

If the machine is not emptied as soon as the program has ended the drum will rotate in short intervals in order to keep the goods from being wrinkled.

Clean the filter

The filter must be cleaned after each drying cycle.

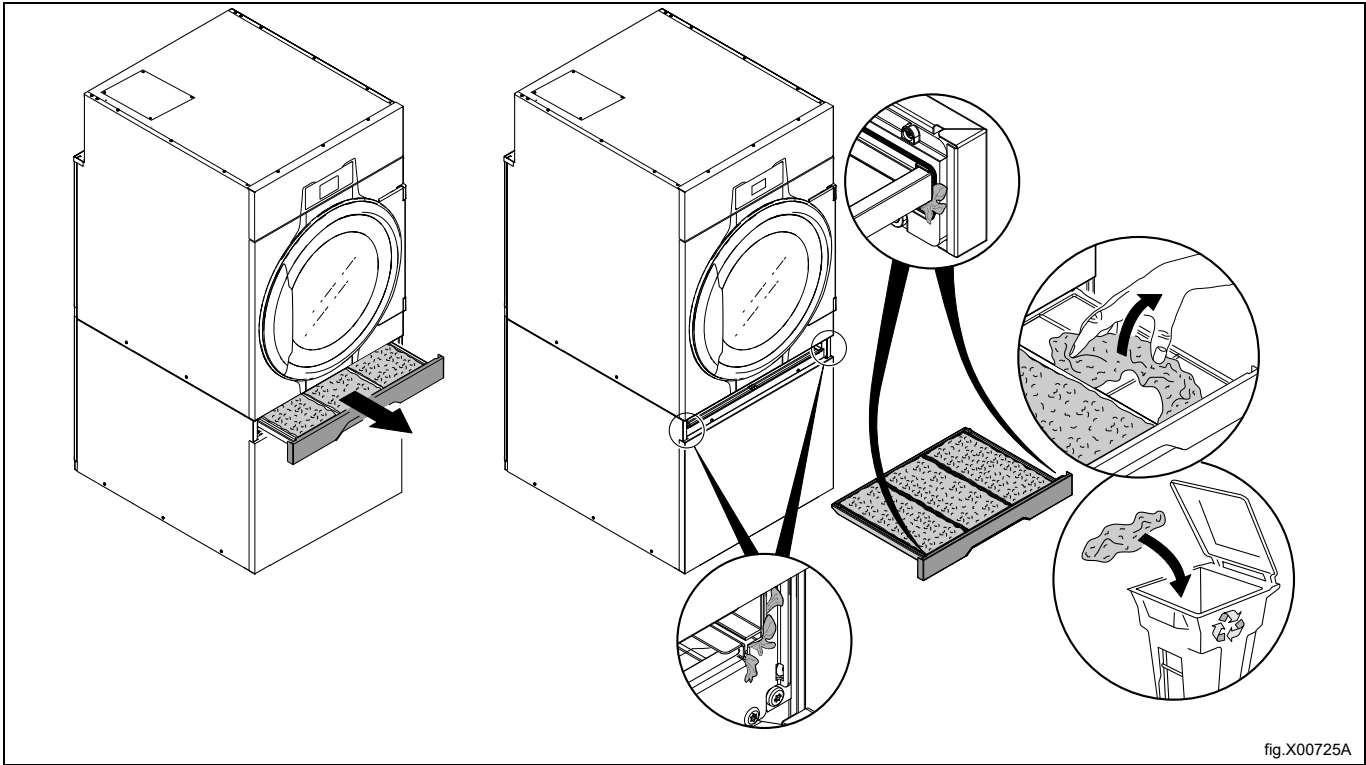

fig.X00725A

Leave the door open when ready. This is to prevent that moisture stays in the machine and develop bacteria and mould.

6 Error codes

A fault in the program or in the machine is indicated by an error code on the display. Some of these error codes can be solved easily without contacting service personnel.

Error code	Text	Cause/Action
12:11	DRYING ERROR WITH RMC PROGRAM	The RMC system (Residual moisture system) in the machine indicates that the garment is not dry enough within the maximum drying time. Check that the machine is not overloaded. Check the parameter setting for max. drying time. Check for blown fuses in mains power supply or that steam or gas supply is sufficient and valve is open.
12:17	AIRFLOW OBSTRUCTED. CONTACT RESPONSIBLE.	Machine indicates that internal filters are clogged and must be cleaned. Contact the responsible/owner of the machine to clean the internal filters according to the Maintenance manual. Restart the machine to clear the error message.
12:18	REDISTRIBUTION OF LOAD NEEDED	Machine indicates that load is blocking the airflow. Redistribute the load. Restart the machine to clear error message.
20:1	O. H. DRUM MOTOR	Machine indicates that drum motor is overheated. Wait 30 minutes to allow the motor to cool. Press ► to clear error message.
30:1	O. H. FAN MOTOR	Machine indicates that the fan motor is overheated. Wait 30 minutes to allow the motor to cool. Press ► to clear error message.

For other error codes or repeated error codes, disconnect the power for 30 seconds. If the error code keeps coming back, contact authorized service personnel.

7 Maintenance

7.1 General

It is the responsibility of the owner of the machine/the laundry manager to make sure that maintenance is periodically performed.

Check the "Maintenance manual" for a complete guide on the maintenance to be performed by the owner of the machine/the laundry manager and also by qualified service personnel.

Note!

Lack of maintenance may deteriorate the performance of the machine and may cause damage to components.

7.2 Time for maintenance

When the display is showing the message TIME FOR MAINTENANCE — contact the owner of the machine/the laundry manager to perform maintenance (if available, a telephone number and/or a tag will also be displayed).

The machine can be used meanwhile. However, the message will keep coming back until the service is performed.

The message will disappear after about 30 seconds or if ►|| is pressed.

7.3 Every day

Check that the machine stops if the door or the filter drawer is opened, if so, the machine must be placed out of order until repairs are made.

Clean the door, door glass, door gasket and other external parts.

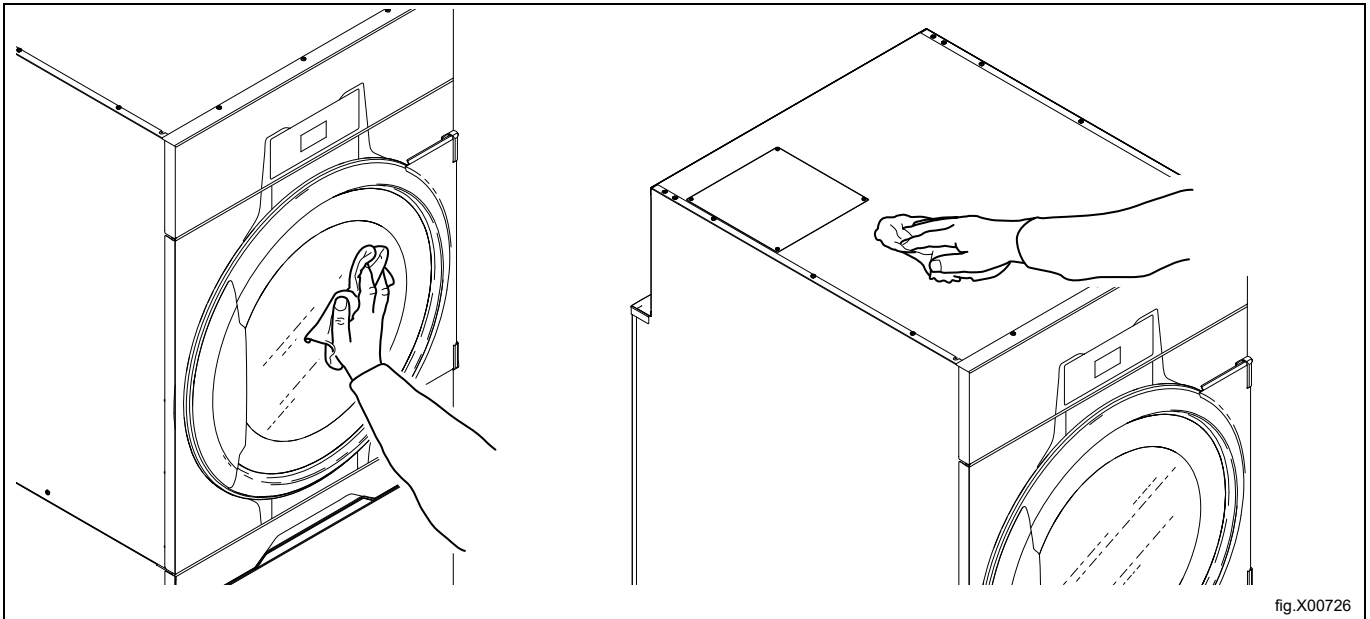

Clean the filter and filter drawer. Check that the parts are not damaged.

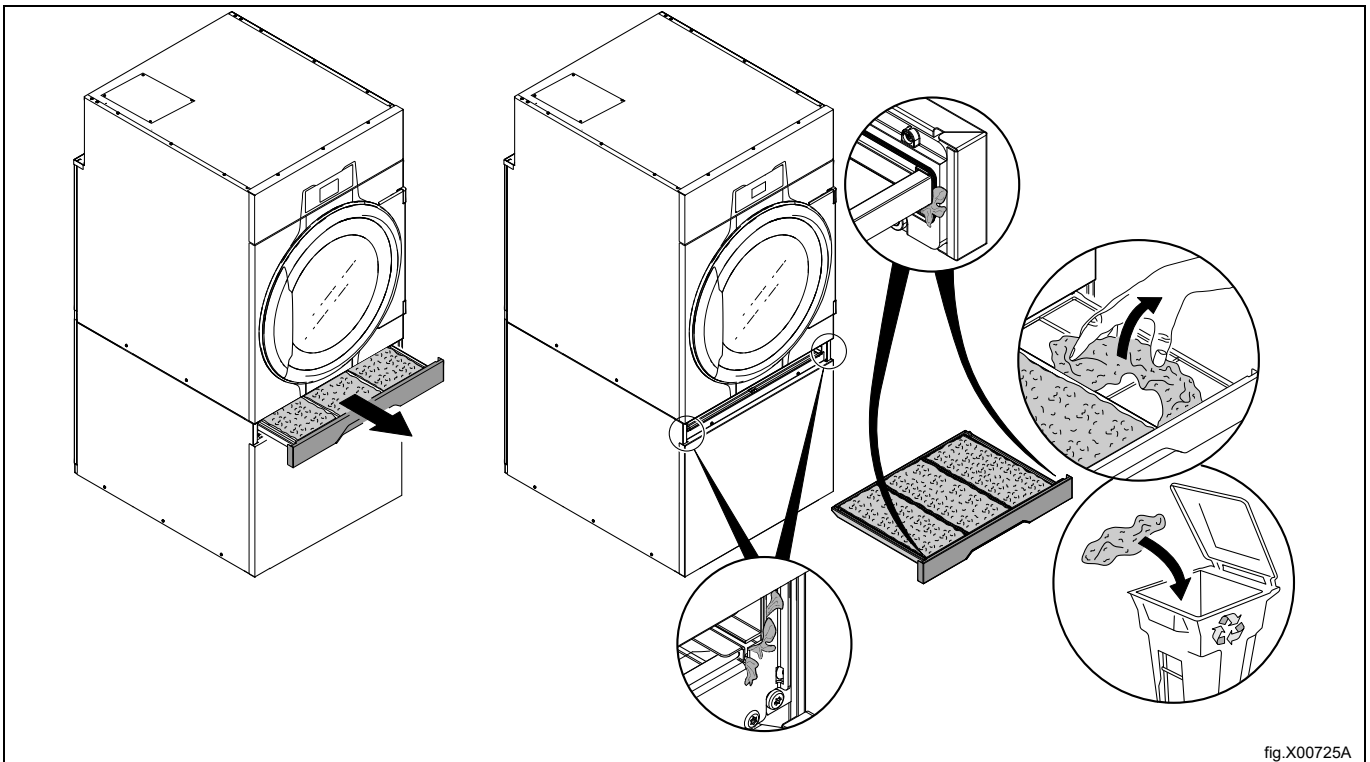

Remove any lint and dust around the machine.



7.4 Machines with heat pump

7.4.1 Second lint filter

There are two warning messages indicating that the second filter shall be cleaned:

1. "CLEAN FIRST AND SECOND FILTER."
2. "CLEAN FIRST AND SECOND FILTER. IF NOTICE REMAINS, CONTACT RESPONSIBLE FOR CHANGING THE SPECIAL FILTER."

If the first and second filter has been cleaned but the warning message remain on the next drying cycle, the special filter must be cleaned or replaced. Contact the owner of the machine/the laundry manager to clean or replace the special filter.

Remove the filter drawer and pull out the second lint filter.

Clean the second lint filter.

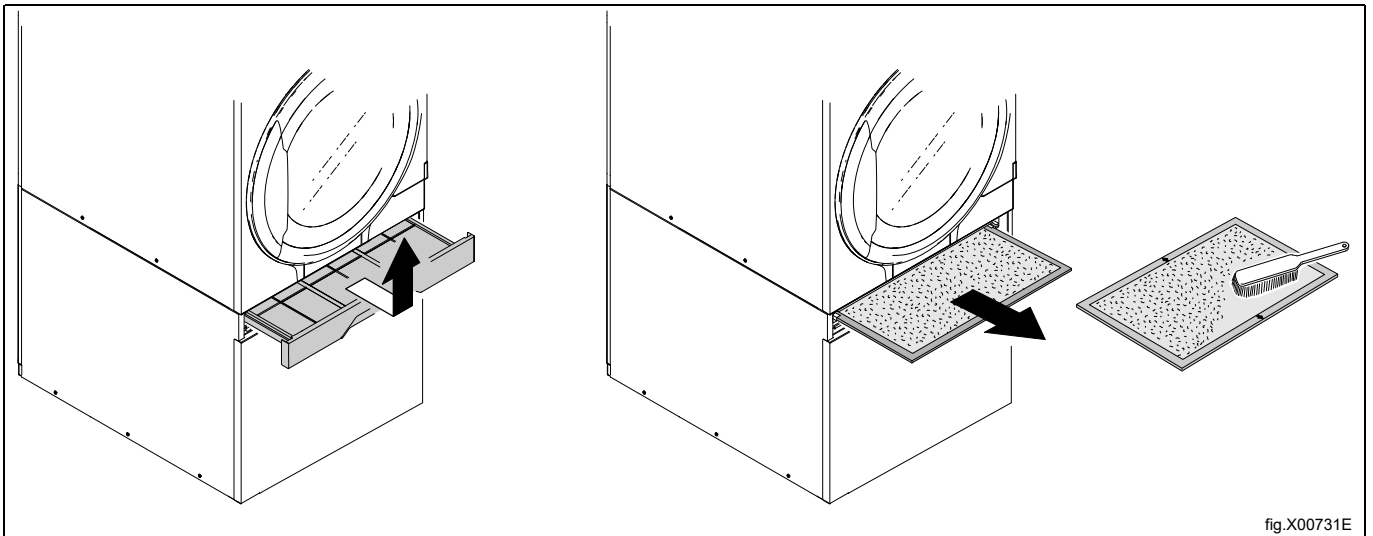

When the second lint filter has been cleaned, insert the second lint filter and the filter drawer.

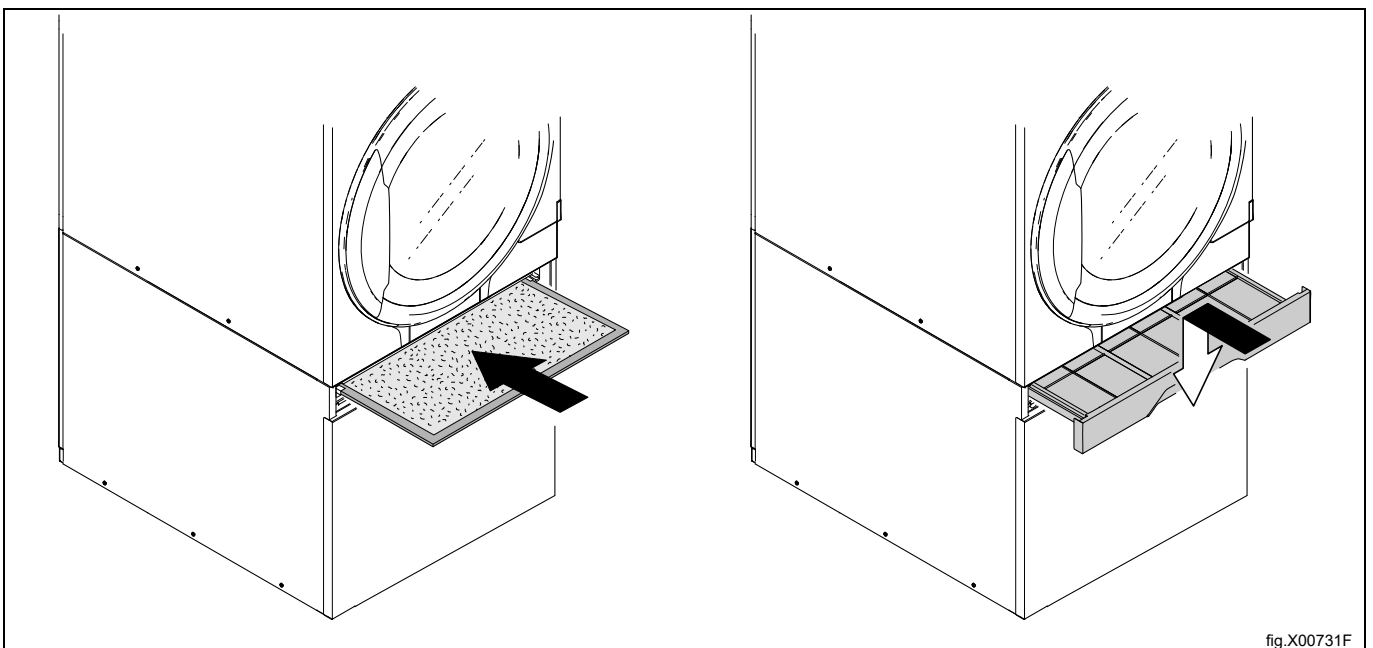

8 Disposal information

8.1 Disposal of appliance at end of life

Before disposing of the machine, make sure to carefully check its physical condition, and in particular any parts of the structure that can give or break during scrapping.

The machine's parts must be disposed of in a differentiated way, according to their different characteristics (e.g. metals, oils, greases, plastic, rubber, etc.).

Different regulations are in force in the various countries, therefore comply with the provisions of the laws and competent bodies in the country where scrapping takes place.

In general, the appliance must be taken to a specialised collection/scrapping centre.

Dismantle the appliance, grouping the components according to their chemical characteristics, remembering that the compressor contains lubricant oil and refrigerant fluid which can be recycled, and that the refrigerator and heat pump components are special waste assimilable with urban waste.

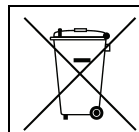

The symbol on the product indicates that this product should not be treated as domestic waste, but must be correctly disposed of in order to prevent any negative consequences for the environment and human health. For further information on the recycling of this product, contact the local dealer or agent, the Customer Care service or the local body responsible for waste disposal.



Note!

When scrapping the machine, any marking, this manual and other documents concerning the appliance must be destroyed.

8.2 Disposal of packing

The packing must be disposed of in compliance with the current regulations in the country where the appliance is used. All the packing materials are environmentally friendly.

They can be safely kept, recycled or burned in an appropriate waste incineration plant. Recyclable plastic parts are marked as following examples.

	Polyethylene: <ul style="list-style-type: none"> • Outer wrapping • Instructions bag
	Polypropylene: <ul style="list-style-type: none"> • Straps
	Polystyrene foam: <ul style="list-style-type: none"> • Corner protectors



Electrolux Professional AB
341 80 Ljungby, Sweden
www.electroluxprofessional.com