

Washer extractor

WH6-27 Clarus Vibe



Washer featuring exceptional savings and effortless use



Priority on people

Certified ergonomic design with a human-centered approach for an outstanding user experience

- ClarusVibe microprocessor and 7" color TS control: intuitive, fully editable programs, multi-language, on-screen statistics, fully controlling the detergent pumps
- Very easy connection to Electrolux pumps Jetsave and Dosave with one cable for power supply and one for dosing signals
- Simple connection to all generic pumps
- Connection to up to 15 pumps



Long-term savings

Innovative features designed for lowest possible water, energy and detergent consumption, to save money and time, and embrace a sustainable lifestyle

- Automatic Savings weighs the linen and adjusts the water level to the amount of linen, saving water and energy at less than full load
- Intelligent Dosing ensures that the precise amount of chemicals will be added automatically according to the weight of the load, saving chemicals
- Power Balance measures, corrects the unbalance and adjusts the G force in real time, maximizing the dewatering, saving money and time in the drying process



Pure control

Monitoring of the status of the equipment and performance from anywhere, allowing to take action to improve the business

- Washers connectable to OnE Laundry, the personal assistant for hygiene validation, process management and revenue management

Main options and accessories

- Front loaded detergent dispenser, positioned at ergonomic height for easy access, clear visibility; 6 color coded compartments make dosing easy and flexible with dedicated compartments for powder or liquid chemicals as well as bleach and softener; removable compartments ensure easy maintenance
- Integrated Savings is measuring the load in real time, ensuring optimization of the load and maximum productivity. IS provides also extended machine lifetime through the unique overload protection function, as machine will not start if overloaded; it will also reduce water and energy consumption at less than full load
- Dosave pumps (peristaltic) and Jetsave pumps (venturi) for less maintenance, precise and consistent dosage, easy installation and durable valves
- Connection to booking-/payment system or coin meter



Images shown are a representation of the product only and variations may occur.

Main specifications				WH6-27			
Max. capacity	filling factor 1:9	kg/lb		27/60			
Drum,	volume	litre		240			
	diameter	ø mm		795			
Extraction		rpm		1005			
G-factor				450			
Standard heating alternatives		electricity	kW	19.1 / 19.8 / 23.0			
		steam		X			
		non-heated		X			
Consumption data "ECO 60°C"				EI		Steam***	
Total time		min		Full load, 27 kg	Half load**, 12 kg	Full load, 27 kg	Half load**, 12 kg
Water consumption (cold+hot)		litre		65	62	65	62
Energy consumption (motor/heating/hot water)		kWh		161+10	76+5	171+0	81+0
Steam consumption		kg		0.55/3.2/0.55	0.55/1.7/0.25	0.55	0.55
Residual moisture		%		-	-	5.6	2.90
				45	46	45	46

* Water temperature 15°C cold water and 65°C hot water.

** Programs with AS.

*** Depending on steam pressure.

Electrical connections					
Heating alternative	Main voltage		Heating power kW	Total power kW	Recommended fuse A
		Hz			
Electric heated	220-230V 3 ~	50/60	19.1	19.8	63
	220-240V 3 ~	50/60	19.8/23.0	20.5/23.7	63/63
	380-400V 3N/3 ~	50/60	19.1	19.8	35
	380-415V 3N/3 ~	50/60	19.8/23.0	20.5/23.7	35/35
	440V 3 ~	50/60	21.0/23.0	21.7/23.7	35/35
	480V 3 ~	60	22.8/23.0	23.5/23.7	35/35
Steam or Non heated	220-415V 1/3N ~	50/60	-	2.6	16
	380-480V 3 ~	50/60	-	2.6	10

* Total power and recommended fuse does not depend on the heating power in those cases.

Water and steam connection		WH6-27
Water valves	DN	20
Water pressure	kPa	200-600
Capacity at 300 kPa	l/min	60
Drain valve	∅ mm	75
Draining capacity	l/min	170
Steam valve	DN	15
Steam pressure	kPa	300-600
Liquid detergent supplies		5
Floor requirements		
Frequency of the dynamic force	Hz	16.8
Floor load at max extraction	kN	5.2 ± 1.0
Sound levels		
Sound power/pressure level at extraction*	dB(A)	83/68
Sound power/pressure level at wash*	dB(A)	64/48
Heat emission		
% of installed power, max		5
Shipping data**		
Weight	net, kg	425
Shipping volume	m ³	1.82
Accessories		
Steel base		x
Hose kits for water or steam		x
Fluff collector		x
Dimensions in mm		
A	Width	1020
B	Depth	990
C	Height	1460
D1		490
D2		555
E		1555
F		1165
G		135
H		1365
I		400
J		300
K		1325
L		1245
M		335
N		100
O		360
P		340
Q		215
1	Display	7 Re-used water
2	Door opening ∅ 435 mm	8 Drain valve
3	Detergent box	9 Liquid detergent supply
4	Cold water	10 Electrical connection
5	Hot water	11 Steam connection
6	Cold/Hot water	

Front and side panels in silver grey and dark blue (color samples can be ordered on part number 47299813).

* Sound power levels measured according to ISO 60704.

** Average data. Crated weight/shipping volume depends on configuration. Please contact logistics for exact measures.

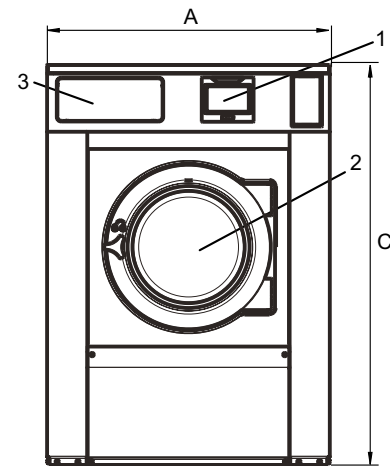

Front

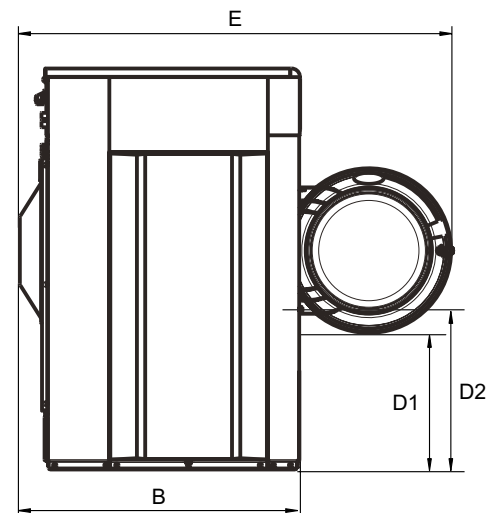

Side view

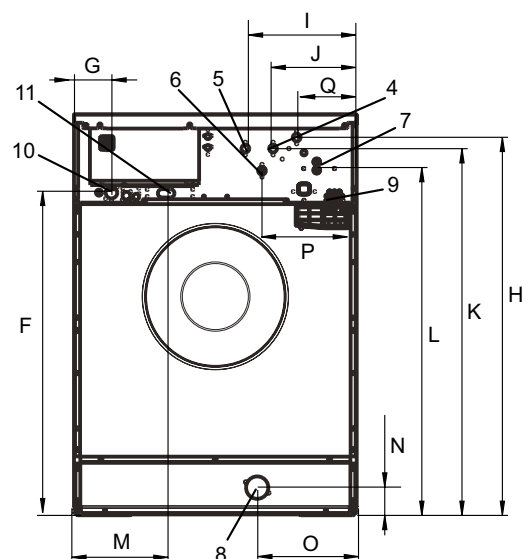

Rear