

High Speed Grill



EN Installation and operating manual *

*Original instructions



595402902 - ed.25- 2024.01

Installation diagram

597400Y01

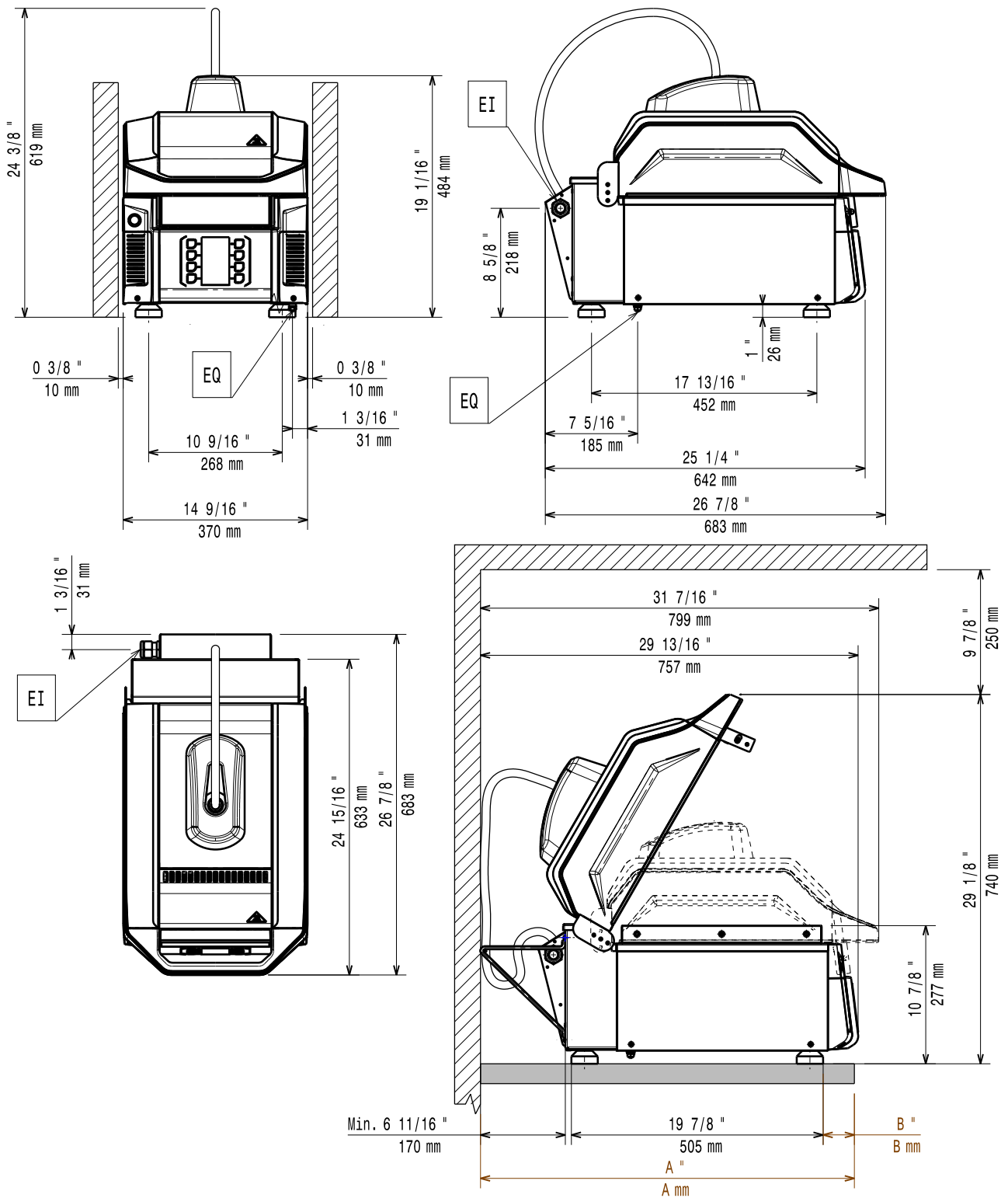

Installation diagram

Marine

597404T00

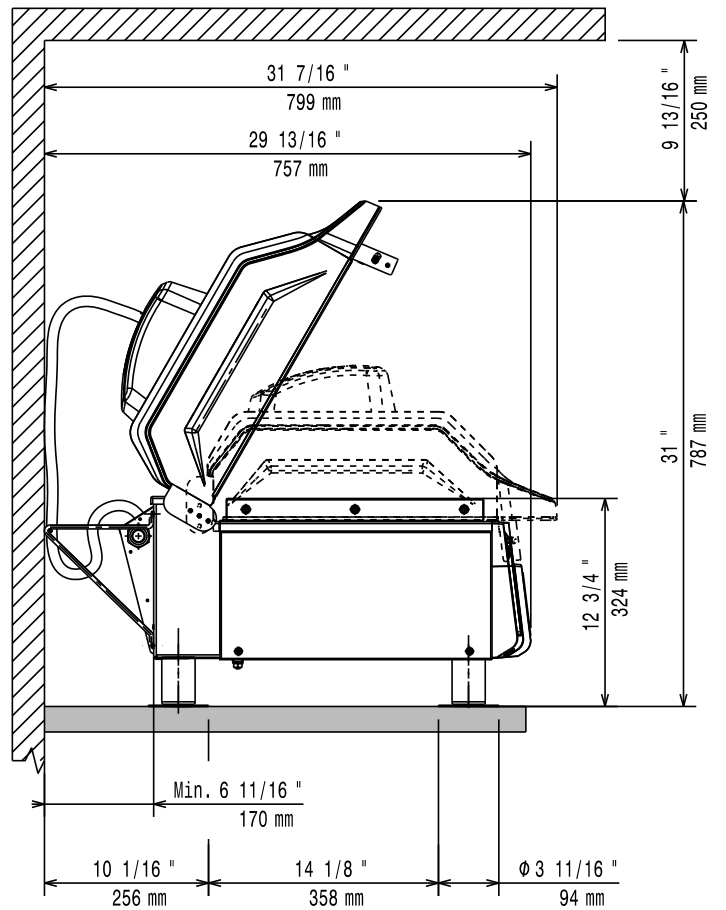
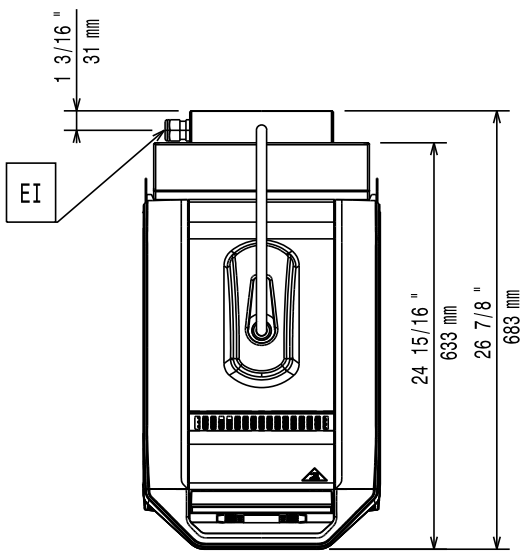
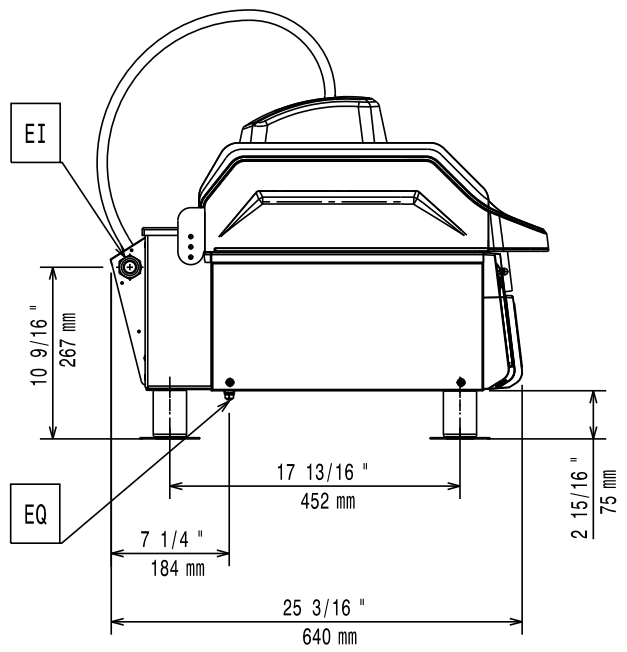
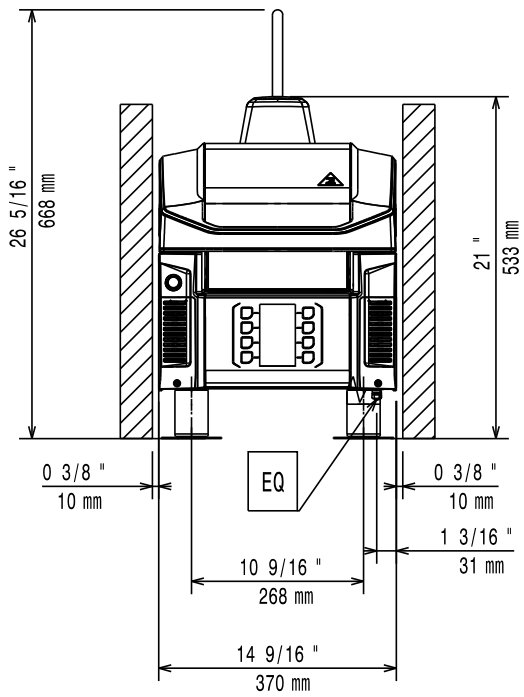

EI = Power cable length 2000 mm / 78.74"

EQ = Equipotential screw

$A \geq 750\text{mm}$ (29 1/2") = Installation recommended

700mm (27 9/16") $\leq A < 750\text{mm}$ (29 1/2") = Mandatory fixing the appliance to the table

$A < 700\text{mm}$ (27 9/16") = Not feasible

$B < 64\text{mm}$ (2 1/2") = Mandatory fixing the appliance to the table

Foreword



Read the following instructions, including the warranty terms before installing and using the appliance.

Visit our website www.electroluxprofessional.com and open the **Support** section to:



Register your product



Get hints & tips of your product, service and repair information

The installation, use and maintenance manual (hereinafter Manual) provides the user with information necessary for correct and safe use of the appliance.

The following must not be considered a long and exacting list of warnings, but rather a set of instructions suitable for improving appliance performance in every respect and, above all, preventing injury to persons and animals and damage to property due to improper operating procedures.

All persons involved in appliance transport, installation, commissioning, use and maintenance, repair and disassembly must consult and carefully read this manual before carrying out the various operations, in order to avoid wrong and improper actions that could compromise the appliance's integrity or endanger people. Make sure to periodically inform the user regarding the safety regulations. It is also important to instruct and update personnel authorised to operate on the appliance, regarding its use and maintenance.

The manual must be available to operators and carefully kept in the place where the appliance is used, so that it is always at hand for consultation in case of doubts or whenever required.

If, after reading this manual, there are still doubts regarding appliance use, do not hesitate to contact the Manufacturer or the authorised Service Centre to receive prompt and precise assistance for better operation and maximum efficiency of the appliance. During all stages of appliance use, always respect the current regulations on safety, work hygiene and environmental protection. It is the user's responsibility to make sure the appliance is started and operated only in optimum conditions of safety for people, animals and property.



IMPORTANT

- The manufacturer declines any liability for operations carried out on the appliance without respecting the instructions given in this manual.
- The manufacturer reserves the right to modify the appliances presented in this publication without notice.
- No part of this manual may be reproduced.
- This manual is available in digital format by:
 - contacting the dealer or reference customer care;
 - downloading the latest and up to date manual on the web site www.electroluxprofessional.com;
- The manual must always be kept in an easily accessed place near the appliance. Appliance operators and maintenance personnel must be able to easily find and consult it at any time.

Contents

A	WARNING AND SAFETY INFORMATION	8
A.1	General information	8
A.2	Personal protection equipment	9
A.3	General safety	9
A.4	Transport, handling and storage	10
A.5	Installation and assembly	10
A.6	Electrical connection	11
A.7	Use: Warnings	11
A.8	Appliance cleaning	12
A.9	Preventive Maintenance	12
A.10	Parts and accessories	13
A.11	Appliance maintenance	13
A.12	Service	13
A.13	Appliance disposal	13
B	WARRANTY TERMS AND EXCLUSIONS	13
C	GENERAL SAFETY RULES	14
C.1	Protection devices installed on the appliance	14
C.2	Safety signs to be placed on the appliance or near its area	14
C.3	End of use	14
C.4	Precautions for use and maintenance	14
C.5	Reasonably foreseeable improper use	15
C.6	Residual risks	15
D	GENERAL INFORMATION	15
D.1	Introduction	15
D.2	Intended use and restrictions	15
D.3	Testing and inspection	15
D.4	Copyright	15
D.5	Keeping the manual	15
D.6	Recipients of the manual	15
D.7	Definitions	16
D.8	Responsibility	16
D.9	Customer packaging checks	16
D.10	Storage	16
E	TECHNICAL DATA	16
E.1	Appliance and manufacturer's identification data	16
E.2	Characteristics of power supply	17
F	INSTALLATION AND ASSEMBLY	17
F.1	Introduction	17
F.2	Customer's responsibilities	17
F.3	Appliance space limits	17
F.4	Positioning	18
F.4.1	Adjustment of the minimal distance between the glass and the upper plate (models equipped only)	18
F.5	Workplace	18
F.6	Feet installation	18
F.7	Anti-opening lid device (if available in your model)	18
F.8	Electrical connection	19
F.9	Disposal of packing	19
G	NORMAL APPLIANCE USE	20
G.1	PRECAUTIONS TO AVOID POSSIBLE EXPOSURE TO EXCESSIVE MICROWAVE ENERGY	20
G.2	Characteristics of personnel enabled to operate on the appliance	20
G.3	Basic requirements for appliance use	20
H	PRODUCT DESCRIPTION	20
H.1	Appliance overview	20
H.2	Control panel overview	20
H.2.1	Display	21
H.3	Non-stick tray	21
I	OPERATING	21
I.1	Start up	21
I.2	Set a program	21
I.3	Basic set up settings	22
I.4	Basic settings	23
I.4.1	UPLOAD / DOWNLOAD APPLIANCE AND PROGRAM SETTING INTO / FROM USB KEY	23
I.4.2	DOWNLOAD LOG CYCLE INTO USB KEY	23
I.4.3	UPLOAD / DOWNLOAD PROGRAM SETTINGS INTO / FROM USB KEY	23
I.4.4	UPLOAD / DOWNLOAD APPLIANCE SETTINGS INTO / FROM USB KEY	23
I.4.5	COUNTERS CONTROL	24
I.4.6	BRIGHTNESS	24
I.4.7	BUZZER SET UP	24
I.4.8	MELODY SET UP	24
I.4.9	TIME SETTING	24
I.4.10	INFO DATA	24

	I.4.11 CONNECTIVITY	25
I.5	Advanced settings	25
	I.5.1 Access to Advanced settings	25
	I.5.2 PROGRAM SETTING - Single Phase	25
	I.5.3 FLEX (models equipped only)	26
	I.5.4 PROGRAM SETTING Multiphase	26
	I.5.5 UPLOAD / DOWNLOAD APPLIANCE AND PROGRAM SETTING INTO/FROM USB KEY	27
	I.5.6 START MODE SETTING	27
	I.5.7 STOP CYCLE OPTION SETTING	27
	I.5.8 UPPER PLATE AND GLASS TEMPERATURE SETTING	28
	I.5.9 STAND-BY SETTING	28
	I.5.10 COUNTERS CONTROL	28
	I.5.11 BRIGHTNESS	28
	I.5.12 BUZZER SET UP – TIME SETTING – INFO DATA	28
	I.5.13 CHANGE PASSWORD	29
	I.5.14 RESET PASSWORD	29
	I.5.15 EXPERT - UNEXPERT SETTING	29
	I.5.16 IMAGE MENU SETTING	30
	I.5.17 CONNECTIVITY SETTING	30
	I.5.18 RECIPES MANAGEMENT FROM CLOUD (if available in your model)	30
I.6	Daily use	30
J	REMOVABLE TEFLON PLATE (RTP)	31
	J.1 Precautions for use	31
	J.2 Unlock the upper plate	31
	J.3 Replace the Removable Teflon Plate	32
	J.4 Fix the upper plate in the lid	32
K	APPLIANCE CLEANING	32
	K.1 Cleaning introduction	32
	K.2 External cleaning	32
	K.3 Daily cleaning	33
	K.3.1 Preliminary actions	33
	K.3.2 Glass and lid	33
	K.3.3 Choke or choke cover cleaning	33
	K.3.4 Cooking chamber	34
	K.3.5 Food tray cleaning	34
	K.3.6 Steam exhaust chamber	35
	K.4 Weekly cleaning	35
	K.4.1 Clean the Removable Teflon Plate	35
	K.4.2 Cooking chamber deep cleaning	35
	K.4.3 Filters cleaning	36
L	APPLIANCE MAINTENANCE	36
	L.1 Care information	36
	L.2 Decommissioning	36
	L.3 Disassembly	36
	L.4 Maintenance intervals	36
	L.5 Periods of non-use	37
M	TROUBLESHOOTING	37
	M.1 Introduction	37
	M.2 Suggestions for quality cooking	38
	M.3 Anomaly table	38
N	APPLIANCE DISPOSAL	44
	N.1 Procedure regarding appliance disposal	44

A WARNING AND SAFETY INFORMATION

A.1 General information

To ensure safe use of the appliance and a proper understanding of the manual it is necessary to be familiar with the terms and typographical conventions used in the documentation. The following symbols are used in the manual to indicate and identify the various types of hazards:



WARNING

Danger for the health and safety of operators.



WARNING

Danger of electrocution - dangerous voltage.



CAUTION

Risk of damage to the appliance or the product.



IMPORTANT

Important instructions or information on the product



Equipotentiality



Read the instructions before using the appliance







Clarifications and explanations

- Only specialised personnel are authorised to operate on the appliance.
- This appliance must not be used by minors and adults with limited physical, sensory or mental abilities or without adequate experience and knowledge regarding its use.
- Do not let children use or play with the appliance.
- Cleaning and user maintenance shall not be made by children.
- Refer to the data given on the appliance's data plate for relations with the Manufacturer (e.g. when ordering spare parts, etc.).
- When scrapping the appliance, the marking must be destroyed.
- Save these instructions carefully for further consultation by the various operators.

A.2 Personal protection equipment

Summary table of the Personal Protection Equipment (PPE) to be used during the various stages of the appliance's service life.

Stage	Protective garments 	Safety footwear 	Gloves 	Glasses 	Safety helmet 
Transport	●	●	○	—	—
Handling	●	●	○	—	—
Unpacking	●	●	○	○	—
Installation	●	●	● ¹	—	—
Normal use	○	○	○ ²	—	—
Adjustments	○	○	○	—	—
Routine cleaning	○	●	● ¹⁻²⁻³	●	—
Extraordinary cleaning	○	●	● ¹⁻²⁻³	●	—
Maintenance	●	●	○	—	—
Dismantling	●	●	○	○	—
Scrapping	●	●	○	○	—
Key:					
●	PPE REQUIRED				
○	PPE AVAILABLE OR TO BE USED IF NECESSARY				
—	PPE NOT REQUIRED				

1. During these operations, gloves must be cut-resistant. Failure to use the personal protection equipment by operators, specialized personnel or users can involve exposure to damage to health (depending on the model).

2. During these operations, gloves must be heatproof to protect hands from contact with hot food or hot parts of the appliance and/or when removing hot items from it. Failure to use the personal protection equipment by operators, specialised personnel or users can involve exposure to chemical risk and cause possible damage to health (depending on the model).

3. During these operations, gloves must be suitable for contact with chemical substances used (refer to the safety data sheet of the substances used for information regarding the required PPE). Failure to use the personal protection equipment by operators, specialized personnel or users can involve exposure to chemical risk and cause possible damage to health (depending on the model).

A.3 General safety

- The appliances are provided with electric and/or mechanical safety devices for protecting workers and the appliance itself.
- Never operate the appliance, removing, modifying or tampering with the guards, protection or safety devices.
- Do not make any modifications to the parts supplied with the appliance.
- Several illustrations in the manual show the appliance, or parts of it, without guards or with guards removed. This is purely for explanatory purposes. Do not use the appliance without the guards or with the protection devices deactivated.

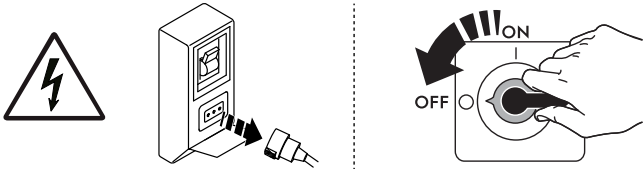

Disconnect the appliance from the power supply before carrying out any installation, assembly, cleaning or maintenance procedure.

- Do not remove, tamper with or make illegible the marking and safety, danger and instruction signs and labels on the appliance.
- The A-weighted emission sound pressure level does not exceed 70 dB(A).¹
- Carefully avoid exposure of the equipment to ozone - do not use ozonizers in the rooms where the equipment is installed.
- The following operations have to be carried out by specialised authorised personnel or Customer Care Service provided with all the appropriate personal protection equipment (A.2 *Personal protection equipment*), tools, utensils and ancillary means, who can ask the manufacturer to supply a servicing manual:
 - Installation and assembly
 - Positioning
 - Electrical connection
 - Appliance cleaning, repair and extraordinary maintenance
 - Appliance disposal
 - Work on electrical equipment

A.4 Transport, handling and storage

- Transport (i. e. transfer of the appliance from one place to another) and handling (i. e. transfer inside workplaces) must occur with the use of special and adequate means.
- Please refer to indications on packaging for stackability during transport, handling and storage.
- Do not stand under suspended loads during loading or unloading operations. Unauthorized personnel must not enter the work area.
- The weight of the appliance alone is not sufficient to keep it steady.
- For appliance handling, do not lift and anchor it to movable or weak parts such as: casings, electrical raceways, pneumatic parts, etc.
- Do not push or pull the appliance to move it, as it may tip over. Use proper tool to lift the appliance.
- Arrange a suitable area with flat floor for appliance unloading and storage operations.
- Appliance transport, handling, shifting and storage personnel must be adequately instructed and trained regarding the safely use of lifting systems and personal protection equipment suitable for the type of operation carried out.
- When removing the anchoring systems, make sure the stability of the appliance parts does not depend on the anchoring and, therefore, that this operation does not cause the load to fall off the vehicle. Before unloading the appliance components, make sure all the anchoring systems are removed.

A.5 Installation and assembly

- The operations described must be carried out in compliance with the current safety regulations and provisions in force in the country of use.
- The plug, if present, must be accessible after positioning the appliance in the place of installation.

1. The noise emission values have been obtained according to EN ISO 11204. The value could increase depending on the workplace where measured.

- The appliance is not suitable for installation outdoors and/or in places exposed to atmospheric agents (rain, direct sunlight, etc.).

A.6 Electrical connection

- The power supply system must be suitable for the rated current of the connected appliance; the connection must be carried out in compliance with the regulations and provisions in force in the country of use.
- The information regarding the appliance power supply voltage and frequency is given on the data plate.
- If the power cable is damaged or too short, it must be replaced by the Customer Care Service or in any case by specialised personnel, in order to prevent any risk.
- The manufacturer declines any liability for damage or injury resulting from breach of the above rules or non-compliance with the electrical safety regulations in force in the country where the appliance is used.

A.7 Use: Warnings

To reduce the risk of burns, electric shock, fire, injury to persons, or exposure to excessive microwave energy

1. Read all instructions before using the appliance.
2. Read and follow the specific G.1 *PRECAUTIONS TO AVOID POSSIBLE EXPOSURE TO EXCESSIVE MICROWAVE ENERGY* paragraph in the relevant chapter.
3. Do not use the appliance without any load.
4. This appliance must be grounded. Connect only to properly grounded outlet. See "GROUNDING INSTRUCTIONS" in F.8 *Electrical connection* chapter.
5. Install or locate this appliance only in accordance with the provided installation instructions.
6. Some products such as whole eggs and sealed containers – for example, closed glass jars – can explode and should not be heated in this appliance.



IMPORTANT

Make sure to apply in a conspicuous place and close to the appliance, the following information supplied: "Warning: liquids or other foods must not be heated in sealed containers since they are liable to explode."

7. Use this appliance only for its intended use as described in the manual. Do not use corrosive chemicals or vapors in this appliance. This type of appliance is specifically designed to heat, cook sandwiches. It is not designed for laboratory use.
8. The appliance is intended only for professional use, not for household application.
9. As with any professional appliance, it cannot be use by unqualified people or children.
10. Do not operate this appliance if it has a damaged cord or plug, if it is not working properly, or if it has been damaged or dropped.
11. Do not use the appliance if it is damaged. It is particularly important that the lid close properly and that there is no damage on the glass.
12. Before each use, the user is responsible of verifying the general integrity and cleanliness of the appliance and stop or no using it in case of noted dirt, damage or missing parts.
13. This appliance should be serviced only by qualified service personnel. Contact nearest authorized service facility for examination, repair, or adjustment.
14. The appliance has an internal air-cooling system (back and front). The air intake and outlet openings of the appliance must not be blocked with objects or cloths, otherwise excessive overheating and damage to the appliance could occur. Do not place objects on the outlets located at the top of the appliance.

15. Do not store this appliance outdoors. Do not use this product near water – for example, near a kitchen sink, in a wet basement, near a swimming pool, or similar locations.
16. Do not immerse the appliance, the upper heating plate, cord or plug in water.
17. Keep the power cord away from any heated surfaces of the appliance.
18. Do not let cord hang over edge of table or counter.
19. To reduce the risk of fire in the heating cavity:
 - a. The appliance is designed for direct heating/cooking of sandwich. Any other use is to be considered improper.
 - b. Do not overcook sandwiches. DO NOT place plastic or other combustible materials, cooking utensils or other item (in all materials it could be) inside the appliance. Place ONLY sandwiches, with the designated specific baking paper (for models equipped).
 - c. If materials inside the appliance ignite, turn appliance off and disconnect the power cord.
 - d. Do not leave things on the glass, do not use the cooking chamber for storage purposes. Do not leave cooking utensils or sandwiches in the cavity when not in use.
 - e. Do not use the appliance to warm sandwich in metallic pots, pans, sheets, utensils.
 - f. Clean regularly the glass and the upper heating plate, removing all the debris. Carbon deposit could overheat the sandwiches and the microwaves can burn the grease and burned deposit.
20. The maximum height of the sandwich to be cooked must not overpass 3"/75 mm.
21. During operation, pay attention to the hot zones of the exterior surface. The cooking zones remain hot. Even with the appliance switched off.
22. As in any microwave appliance, sparks can occur inside the cooking chamber. These sparks do not influence the safety of the user nor the appliance nor the quality of the sandwich. If, because of the sparking, a dark mark on the metal part is visible, this can be cleaned with a damp cloth.
23. Periodically clean the appliance, removing all traces of sandwich; failure to keep it clean will lead to deterioration of the surfaces.
24. The supplied tool (scraper) shall to be used only for cleaning purpose. See K.3 *Daily cleaning* chapter.
25. Have the appliance fully checked periodically (at least once a year). For that purpose, it is advisable to stipulate a maintenance contract.
26. It is hazardous for anyone other than a competent person to carry out any service or repair operation that removal of any cover which gives protection against exposure to microwave energy

SAVE THESE INSTRUCTIONS CAREFULLY FOR FURTHER CONSULTATION BY THE VARIOUS OPERATORS

A.8 Appliance cleaning

- Do not touch the appliance with wet hands or feet or when barefoot.
- Put the appliance in safe conditions before starting any cleaning operation.
- Respect the requirements for the various routine and extraordinary maintenance operations. Non-compliance with the instructions can create risks for personnel.
- Do not spray water or use water jets, steam cleaner or high pressure cleaner.

A.9 Preventive Maintenance

In order to ensure the safety and performance of your equipment, it is recommended that service is undertaken by Electrolux Professional authorised engineers every 12 months, in

accordance with Electrolux Professional Service Manuals. Please contact your local Electrolux Professional Service Centre for further details.

A.10 Parts and accessories

Use only original accessories and/or spare parts. Failure to use original accessories and/or spare parts will invalidate the original manufacturer warranty and may render the appliance not compliant with the safety standard.

A.11 Appliance maintenance

- The inspection and maintenance intervals depend on the actual appliance operating conditions and ambient conditions (presence of dust, damp, etc.), therefore precise time intervals cannot be given. In any case, careful and periodical appliance maintenance is advisable in order to minimise service interruptions.
- It is advisable to stipulate a preventive and scheduled maintenance contract with the Customer Care Service.
- Put the appliance in safe conditions before starting any maintenance operation.
- The plug must be in a position always visible to the operator performing the intervention during maintenance operations.
- To guarantee appliance efficiency and correct operation, periodical maintenance must be carried out according to the instructions given in the manual.

A.12 Service

PRECAUTIONS TO BE OBSERVED BEFORE AND DURING SERVICING TO AVOID POSSIBLE EXPOSURE TO EXCESSIVE MICROWAVE ENERGY

- Do not operate or allow the oven to be operated with the door open.
- Make the following safety checks on all ovens to be serviced before activating the magnetron or other microwave source, and make repairs as necessary:
 1. interlock operation,
 2. proper door closing
 3. seal and sealing surfaces (arcing, wear, and other damage),
 4. damage to or loosening of hinges and latches,
 5. evidence of dropping or abuse.
- Before turning on microwave power for any service test or inspection within the microwave generating compartments, check the magnetron, wave guide or transmission line, and cavity for proper alignment, integrity, and connections.
- Any defective or misadjusted components in the interlock, monitor, door seal, and microwave generation and transmission systems shall be repaired, replaced, or adjusted by procedures described in this manual before the oven is released to the owner.
- Only original spare parts can ensure the safety standards of the appliance.

A.13 Appliance disposal

- Make the appliance unusable by removing the power cable and any compartment closing devices, to prevent the possibility of someone becoming trapped inside.

B WARRANTY TERMS AND EXCLUSIONS

If the purchase of this product includes warranty coverage, warranty is provided in line with local regulations and subject to the product being installed and used for the purposes as designed, and as described within the appropriate equipment documentation.

Warranty will be applicable where the customer has used only genuine spare parts and has performed maintenance in accordance with Electrolux Professional user and maintenance documentation made available in paper or electronic format.

Electrolux Professional strongly recommends using Electrolux Professional approved cleaning, rinse and descaling agents to obtain optimal results and maintain product efficiency over time.

The Electrolux Professional warranty does not cover:

- service trips cost to deliver and pick up the product;
- installation;
- training on how to use/operate;
- replacement (and/or supply) of wear and tear parts unless resulting from defects in materials or workmanship reported within one (1) week from the failure;
- correction of external wiring;
- correction of unauthorized repairs as well as any damages, failures and inefficiencies caused by and/or resulting from:
 - insufficient and/or abnormal capacity of the electrical systems (current/voltage/frequency, including spikes and/or outages);
 - inadequate or interrupted water supply, steam, air, gas (including impurities and/or other that does not comply with the technical requirements for each appliance);
 - plumbing parts, components or consumable cleaning products that are not approved by the manufacturer;
 - customer's negligence, misuse, abuse and/or non-compliance with the use and care instructions detailed within the appropriate equipment documentation;
 - improper or poor: installation, repair, maintenance (including tampering, modifications and repairs carried out by third parties not authorized) and modification of safety systems;

- Use of non-original components (e. g.: consumables, wear and tear, or spare parts);
- environment conditions provoking thermal (e. g. overheating/freezing) or chemical (e. g. corrosion/oxidation) stress;
- foreign objects placed in- or connected to- the product;
- accidents or force majeure;
- transportation and handling, including scratches, dents, chips, and/or other damage to the finish of the product, unless such damage results from defects in materials or workmanship and is reported within one (1) week of delivery unless otherwise agreed;
- product with original serial numbers that have been removed, altered or cannot be readily determined;
- replacement of light bulbs, filters or any consumable parts;
- any accessories and software not approved or specified by Electrolux Professional.

Electrolux Professional warranty will be void and manufacturer shall have no liability related thereto in case of any modification of the product or related hardware/software/programming.

Warranty does not include scheduled maintenance activities (including the parts required for it) or the supply of cleaning agents unless specifically covered within any local agreement, subject to local terms and conditions.

Check on Electrolux Professional website the list of authorized customer care.

C GENERAL SAFETY RULES



WARNING

Refer to “*Warning and safety information*”.

C.1 Protection devices installed on the appliance

Guards

The appliance has:

- fixed guards (e.g. casings, covers, side panels, etc.), fixed to the appliance and/or frame with screws or quick-release connectors that can only be removed or opened with tools; therefore the user must not remove or tamper with such devices. The Manufacturer declines any liability for damage due to tampering or their non-use;
- interlocked movable guards (door) for access inside the appliance;
- appliance electrical equipment access panels or doors, made from hinged panels openable with tools. The panel or the door must not be opened when the appliance is connected to the power supply.

C.2 Safety signs to be placed on the appliance or near its area

Prohibition	Meaning
	do not remove the safety devices
	do not use water to extinguish fires (placed on electrical parts)

Danger	Meaning
	danger of crushing hands
	caution hot surface
	danger of electrocution (shown on electrical parts with indication of voltage)

C.3 End of use

When the appliance is no longer to be used, make it unusable by removing the mains power supply wiring.

C.4 Precautions for use and maintenance

- Risks mainly of a mechanical, thermal and electrical nature exist in the appliance. Where possible the risks have been neutralised:
 - directly, by means of adequate design solutions.
 - indirectly by using guards, protection and safety devices.
- Any anomalous situations are signalled on the control panel display.
- During maintenance several risks remain, as these could not be eliminated, and must be neutralised by adopting specific measures and precautions.
- Do not carry out any checking, cleaning, repair or maintenance operations on moving parts. Workers must be informed of this prohibition by means of clearly visible signs.
- Make sure to periodically check correct operation of all the safety devices and the insulation of electrical cables, which must be replaced if damaged.

In case of a significant anomaly (e.g. short circuits, wires coming out of the terminal block, motor breakdowns, worn electrical cable sheathing, etc.) the operator for normal appliance use must:

- immediately deactivate the appliance and disconnect all the supplies (electricity, gas, water).

C.5 Reasonably foreseeable improper use

Improper use is any use different from that specified in this manual. During appliance operation, other types of work or activities deemed improper and that in general can involve risks for the safety of operators and damage to the appliance are not allowed. Reasonably foreseeable improper use includes:

- lack of appliance maintenance, cleaning and periodical checks;
- structural changes or modifications to the operating logic;
- tampering with the guards or safety devices;
- failure to use personal protection equipment by operators, specialised personnel and maintenance personnel;
- failure to use suitable accessories (e.g. use of unsuitable equipment or ladders);
- keeping combustible or flammable materials, or in any case materials not compatible with or pertinent to the work, near the appliance;
- wrong appliance installation;
- placing in the appliance any objects or things not compatible with its use, or that can damage the appliance, cause injury or pollute the environment;
- climbing on the appliance;
- non-compliance with the requirements for correct appliance use;
- other actions that give rise to risks not eliminable by the Manufacturer.

C.6 Residual risks

The appliance has several risks that were not completely eliminated from a design standpoint or with the installation of adequate protection devices. Nevertheless, through this manual the Manufacturer has taken steps to inform operators of such risks, carefully indicating the personal protection

equipment to be used by them. In order to reduce the risks, provide for sufficient spaces while installing the unit.

To preserve these conditions, the areas around the appliance must always be:

- kept free of obstacles (e.g. ladders, tools, containers, boxes, etc.);
- clean and dry;
- well lit.

For the Customer's complete information, the residual risks remaining on the appliance are indicated below: such actions are deemed improper and therefore strictly forbidden.

Residual risk	Description of hazardous situation
Slipping or falling	The operator can slip due to water, any liquid or dirt on the floor
Burns/abrasions (e.g. heating elements, cold pan, cooling circuit plates and pipes)	The operator deliberately or unintentionally touches some components inside the appliance without using protective gloves.
Electrocution	Contact with live parts during maintenance operations carried out with the electrical panel powered
Crushing or shearing	Possible risk of injury to upper limbs during the closing operation of the appliance lid.
Tipping of loads	When handling the appliance or the packing containing it, using unsuitable lifting systems or accessories or with the unbalanced load
Chemical	Contact with chemical substances (e.g. detergent, rinse aid, scale remover, etc.) without taking adequate safety precautions. Therefore always refer to the safety cards and labels on the products used.

D GENERAL INFORMATION

D.1 Introduction

This manual contains information relevant to various appliances. The product images in this guide are only an example.

The drawings and diagrams given in the manual are not in scale. They supplement the written information with an outline, but are not intended to be a detailed representation of the appliance supplied.

The numerical values given on the appliance installation diagrams refer to measurements in millimeters and/or inches.

D.2 Intended use and restrictions

This appliance is designed for heating/cooking snacks. Any other use is deemed improper.



NOTE!

The manufacturer declines any liability for improper use of the product.

D.3 Testing and inspection

Our appliances have been designed and optimized, with laboratory testing, in order to obtain high performance and efficiency.

The appliance is shipped ready for use.

Passing of the tests (visual inspection - electrical test - functional test) is guaranteed and certified by the specific enclosures.

D.4 Copyright

This manual is intended solely for consultation by the operator and can only be given to third parties with the permission of Electrolux Professional SpA company.

D.5 Keeping the manual

The manual must be carefully kept for the entire life of the appliance, until scrapping. The manual must stay with the appliance in case of transfer, sale, hire, granting of use or leasing.

D.6 Recipients of the manual

This manual is intended for:

- the carrier and handling personnel;
- installation and commissioning personnel;
- the employer of appliance users and the workplace manager;
- operators for normal appliance use;
- specialised personnel - Customer Care service (see service manual).

D.7 Definitions

Listed below are the definitions of the main terms used in the manual. It is advisable to read them carefully before use.

Operator	appliance installation, adjustment, use, maintenance, cleaning, repair and transport personnel.
Manufacturer	Electrolux Professional SpA or any other service centre authorised by Electrolux Professional SpA.
Operator for normal appliance use	an operator who has been informed and trained regarding the tasks and hazards involved in normal appliance use.
Customer Care service or specialised personnel	an operator instructed/trained by the Manufacturer and who, based on his professional and specific training, experience and knowledge of the accident-prevention regulations, is able to appraise the operations to be carried out on the appliance and recognise and prevent any risks. His professionalism covers the mechanical, electrotechnical and electronics fields etc.
Danger	source of possible injury or harm to health.
Hazardous situation	any situation where an operator is exposed to one or more hazards.
Risk	a combination of probabilities and risks of injury or harm to health in a hazardous situation.
Protection devices	safety measures consisting of the use of specific technical means (guards and safety devices) for protecting operators against risks.
Guard	an element of a appliance used in a specific way to provide protection by means of a physical barrier.
Safety device	a device (other than a guard) that eliminates or reduces the risk; it can be used alone or in combination with a guard.
Customer	the person who purchased the appliance and/or who manages and uses it (e. g. company, entrepreneur, firm).
Electrocution	an accidental discharge of electric current on a human body.

D.8 Responsibility

The Manufacturer declines any liability for damage and malfunctioning caused by:

- non-compliance with the instructions contained in this manual;
- repairs not carried out in a workmanlike fashion, and replacements with parts different from those specified in the spare parts catalogue (the fitting and use of non-original spare parts and accessories can negatively affect appliance operation and invalidates the original manufacturer warranty);

- operations carried out by non-specialised personnel;
- unauthorized modifications or operations;
- missing, lack or inadequate maintenance;
- improper appliance use;
- unforeseeable extraordinary events;
- use of the appliance by uninformed and / or untrained personnel;
- non-application of the current provisions in the country of use, concerning safety, hygiene and health in the workplace.

The Manufacturer declines any liability for damage caused by arbitrary modifications and conversions carried out by the user or the Customer.

The employer, workplace manager or service technician are responsible for identifying and choosing adequate and suitable personal protection equipment to be worn by operators, in compliance with regulations in force in the country of use.

The Manufacturer declines any liability for inaccuracies contained in the manual, if due to printing or translation errors.

Any supplements to the installation, use and maintenance manual the Customer receives from the Manufacturer will form an integral part of the manual and therefore must be kept together with it.

D.9 Customer packaging checks

- The forwarder is responsible for the goods during transport and delivery.
- Make a complaint to the forwarder in case of visible or hidden damage.
- Specify any damage or shortages on the dispatch note.
- The driver must sign the dispatch note; the forwarder can reject the claim if the dispatch note is not signed (the forwarder can provide the necessary form).
- For hidden damage or shortages becoming apparent only after unpacking, request the forwarder for inspection of the goods within and no later than 15 days after delivery.

After packaging checks

1. Remove the packaging.
Take care when unpacking and handling of the appliance to not cause any shocks on itself.
2. Keep all the documentation contained in the packaging.

D.10 Storage

The appliance and/or its parts must be stored and protected from damp, in a non-aggressive place, free of vibrations and with room temperatures between $-10\text{ }^{\circ}\text{C}$ [$14\text{ }^{\circ}\text{F}$] and $50\text{ }^{\circ}\text{C}$ [$122\text{ }^{\circ}\text{F}$].

The place where the appliance is stored must:

- can take the appliance load,
- have a flat support surface to avoid deforming the appliance or damage to the support feet.

E TECHNICAL DATA

E.1 Appliance and manufacturer's identification data

The data plate gives the product identification and technical data.

An example of the marking or data plate on the appliance is given below:

F.Mod. []	Comm.Mod. []	Ser.No. []	[]
PNC []	[]	Type ref. []	[]
EL: []	- [] Hz	[] kW	I _{max} : [] A
			MW freq []
IPX			
Electrolux Professional SpA - Viale Treviso, 15 - 33170 Pordenone (Italy)			CE

The meaning of the various information given on it is listed below:

F.Mod.	factory description of product
Comm.Mod.	commercial description
PNC	production number code
Ser.No.	serial number
Type ref.	certification group of the appliance
V	power supply voltage
Hz	power supply frequency
kW	power input
A	absorbed current
MW freq	microwaves frequency
CE	CE marking
	WEEE symbol
IPX4	dust and water protection rating

E.2 Characteristics of power supply

The AC power supply to the machine must meet the following conditions:

- max. voltage variation $\pm 5\%$
- max. frequency variation $\pm 1\%$ continuous $\pm 2\%$ for a short period.

Harmonic distortion, unbalanced three-phase supply voltage, voltage pulses, interruption, dips and the other electric characteristics must respect the provisions of point 4.3.2 of Standard EN 60204-1 (IEC 60204-1).



WARNING

The machine's power supply must be protected against over-current (short circuits and overloads) by fuses or suitable thermal magnetic circuit breakers. A suitable high-sensitivity manual-reset differential omnipolar thermal-magnetic switch with contact gap enabling complete disconnection in category III overvoltage conditions and complying with the current regulations, must be installed between the power cable and the electric line.



WARNING

For protection against indirect contacts (depending on the type of supply provided for and connection of earths to the equipotential protection circuit) refer to point 6.3.3 of EN 60204-1 (IEC 60204-1) with the use of protection devices that ensure automatic cut-off of the supply in case of isolation fault in the TN or TT systems or, for IT systems, the use of isolation controllers or differential current protection devices to activate automatic power disconnection (an isolation controller must be provided for indicating a possible first earth fault of a live part, unless a protection device is supplied for switching off the power in case of a such a fault. This device must activate an acoustic and/or visual signal which must continue for the entire duration of the fault). For example: in a TT system, a differential switch with cut-in current (e. g. 30 mA) coordinated with the earthing system of the building where the machine is located must be installed ahead of the supply.

F INSTALLATION AND ASSEMBLY

F.1 Introduction



WARNING

Refer to "*Warning and safety information*".

To ensure correct operation of the appliance and maintain safe conditions during use, carefully follow the instructions given in this chapter.

Check and, if necessary, level the appliance after positioning. Incorrect levelling can cause appliance malfunctioning.

F.2 Customer's responsibilities

The tasks and works required of the Customer are:

- check the floor planarity on which the appliance is placed;
- arrange an earthed power socket of suitable capacity for the input specified on the data plate;



NOTE!

For information regarding the electrical connection, refer to "*A.6 Electrical connection*".

F.3 Appliance space limits

- A suitable space must be left around the appliance (for operations, maintenance, etc.).

- The passages enabling personnel to operate on the appliance must be at least 50 mm wide, except at the rear of the appliance.
- This space must be increased in case of use and/or transfer of other equipment and/or means or if exit routes are necessary inside the workplace.
- To be used to keep the correct distances indicated in the installation diagram.

F.4 Positioning



CAUTION

- This appliance is not designed for built-in installation.
- The appliance must be levelled.
- Do not obstruct the vent holes of the appliance.
- The weight of the appliance is 47 kg. Be careful!

Unpack the machine, carrying out the following operations:

1. Wear protective gloves. Refer to "A.2 Personal protection equipment" for further information.
2. Cut the straps and remove the protective film, taking care not to scratch the surface if scissors or blades are used;
3. Remove the cardboard top, the polystyrene corners and the vertical protection pieces.
4. Install the appliance, taking all the safety precautions required for this type of operation, also respecting the relevant fire-prevention instructions.

Install the appliance in a ventilated place. Refer to "Warning and safety information".

- Do not install the appliance adjacent to any high heat or grease producing piece of appliance, such as a range top, griddle, fryer, etc., that could allow radiant heat to raise the exterior temperature of the appliance.
- For the overall space required and connection dimensions, refer to the installation diagrams given on the first pages of this manual.

F.4.1 Adjustment of the minimal distance between the glass and the upper plate (models equipped only)

- 0 chock: H = approximately 13 mm
- 1 chock: H = approximately 24 mm
- 2 chocks: H = approximately 35 mm
- 3 chocks: H = approximately 46 mm
- 4 chocks: H = approximately 57 mm



NOTE!

The number of chocks is given starting from the top (see example).

- 4 chocks

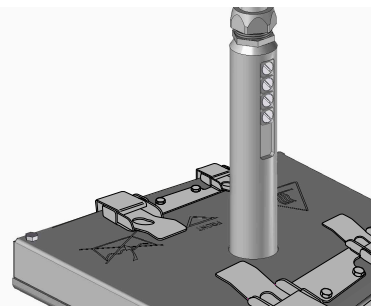

- 2 chocks

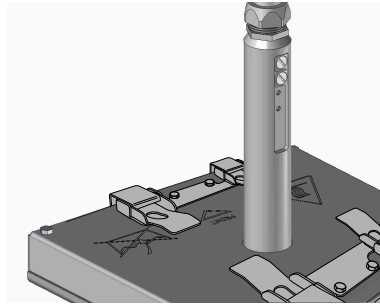

F.5 Workplace

All the laws, regulations and directives in force in the place of installation regarding the following must be observed.

- Correct lighting of workplaces.
- Safety in the workplace, accident prevention.
- Compulsory signs and signals.
- Hygiene.
- Work zones and separation of paths for hygienic purposes.
- Fire prevention.
- Low air pollution emissions.

F.6 Feet installation

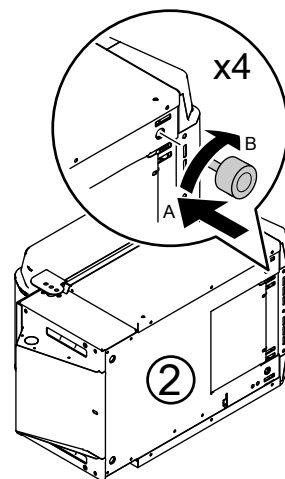
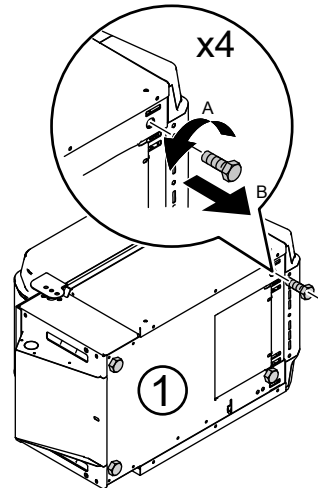

F.7 Anti-opening lid device (if available in your model)

During the moving of the appliance insert the special device to prevent accidental opening of the lid (see the following figure).

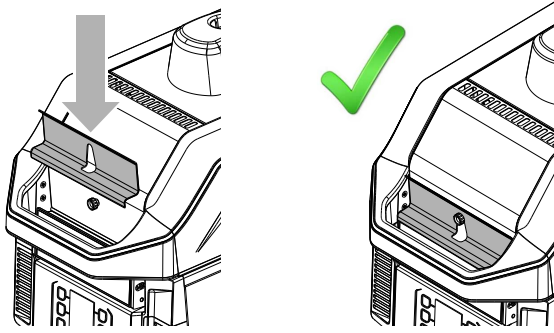

F.8 Electrical connection



WARNING

Refer to “*Warning and safety information*”



IMPORTANT

Connection to the power supply must be carried out in compliance with the regulations and provisions in force in the country of use.

- Make sure the system power supply is arranged and able to take the actual current load and that it is executed in a workmanlike manner according to the regulations in force in the country of use.
- The plug must be accessible after positioning the appliance in the place of installation. Make sure the plug is not crushed by the appliance. A damaged power cable can overheat and catch fire or cause a short circuit.
- Make sure the machine power supply voltage specified on the data plate matches the mains voltage.
- Make sure that the socket has an efficient ground contact.



IMPORTANT

For Japan three-phase models:

Connect the free wire terminals according to the sequence indicated in the wire marking L1 - L2 - L3. See following diagram:

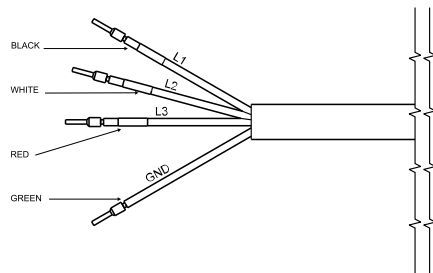

CAUTION

GROUNDING INSTRUCTIONS: This appliance must be grounded. In the event of an electrical short circuit, grounding reduces the risk of electric shock by providing an escape wire for the electric current. This appliance is equipped with a cord having a grounding wire with a grounding plug. The plug must be plugged into an outlet that is properly installed and grounded;



WARNING

Improper use of the grounding can result in a risk of electric shock.

Consult a qualified electrician or serviceman if the grounding instructions are not completely understood, or if doubt exists as to whether the appliance is properly grounded, and either:

1. If it is necessary to use an extension cord, use only a 3-wire extension cord that has a 3-blade grounding plug, and a 3-slot receptacle that will accept the plug on the appliance. The marked rating of the extension cord shall be equal to or greater than the electrical rating of the appliance, or
2. Do not use an extension cord, if the power supply cord is too short, have a qualified electrician or serviceman install an outlet near the appliance.



WARNING

Earthing is mandatory, using a green conductor.

Whenever the power cable has to be replaced, call a technical service agent and replace by original spare parts: only the manufacturer of the appliance is authorized to supply the replacement part and carry out disassembly and reassembly of the components, directly or through Authorized Assistance Centers.



IMPORTANT

Repair and maintenance work must be carried out only by qualified personnel authorized by the manufacturer.

Always install a main switch with thermal magnetic cut-out up line of the appliance in order to be able to isolate it from the rest of the system. Contact opening distance and maximum leakage current must comply with current regulations

- Connect the mains plug to the mains socket only at the end of the installation.
- Always use a correctly installed shockproof socket.
- Do not use multi-plug adapters and extension cables.
- Do not pull the mains cable to disconnect the appliance. Always pull the mains plug.
- Do not touch the mains cable or the mains plug with wet hands.
- The equipment must also be included in an equipotential system, whose connection is made by means of screw “EQ” (see “Installation diagram”) indicated by the symbol ∇ . The equipotential wire must have a section of at least 10 mm².

F.9 Disposal of packing

The packing must be disposed of in compliance with the current regulations in the country where the appliance is used. All the packing materials are environmentally friendly.

They can be safely kept, recycled, or burned in an appropriate waste incineration plant. Recyclable plastic parts are marked as follows:



Polyethylene

- Outer wrapping
- Instructions bag



Polypropylene

- Straps



Polystyrene foam

- Corner protectors

The parts in wood and cardboard can be disposed of, respecting the current regulations in the country where the appliance is used.

G NORMAL APPLIANCE USE

G.1 PRECAUTIONS TO AVOID POSSIBLE EXPOSURE TO EXCESSIVE MICROWAVE ENERGY

- Do not attempt to operate this oven with the door open since open door operation can result in harmful exposure to microwave energy. It is important not to defeat or tamper with the safety interlocks.
- Do not place any object between the oven front face and the door or allow soil or cleaner residue to accumulate on sealing surfaces.
- Do not operate the oven if it is damaged. It is particularly important that the oven door close properly and that there is no damage to the:
 - a. the door (bent)
 - b. hinges and latches (broken or loosened)
 - c. door seals and sealing surfaces
- The oven should not be adjusted or repaired by anyone except properly qualified service personnel.

G.2 Characteristics of personnel enabled to operate on the appliance

The Customer must make sure the personnel for normal appliance use are adequately trained and skilled in their duties.

The operator must:

- read and understand the manual;
- receive adequate training and instruction for their duties in order to operate safely;
- receive specific training for correct appliance use.



IMPORTANT

The Customer must make sure his personnel have understood the instructions received and in particular those regarding work hygiene and safety in use of the appliance.

G.3 Basic requirements for appliance use

- Knowledge of the technology and specific experience in operating the appliance.
- Adequate general basic education and technical knowledge for reading and understanding the contents of the manual, including correct interpretation of the drawings, signs and pictograms.
- Sufficient technical knowledge for safely performing his duties as specified in the manual.
- Knowledge of the regulations on work hygiene and safety.

H PRODUCT DESCRIPTION

H.1 Appliance overview

Use the appliance to cook or heat snacks.

The appliance has three different heating elements:

- contact plates,
- infrared radiation,
- microwaves.

Front view

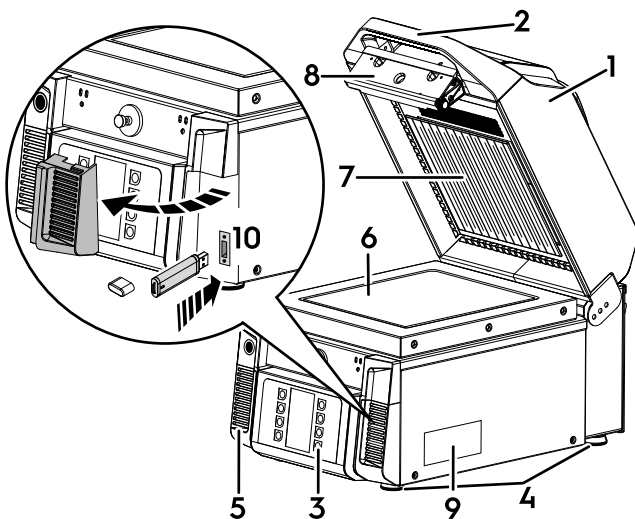

1. Lid
2. Handle
3. Control panel
4. Feet
5. Ventilation holes
6. Glass
7. Upper plate
8. Lock device
9. Data plate
10. USB key position

Rear view

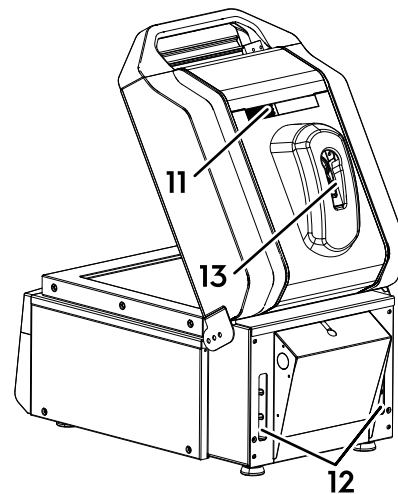

11. Steam evacuation chamber
12. Ventilation holes
13. Upper plate with respective locking device

H.2 Control panel overview

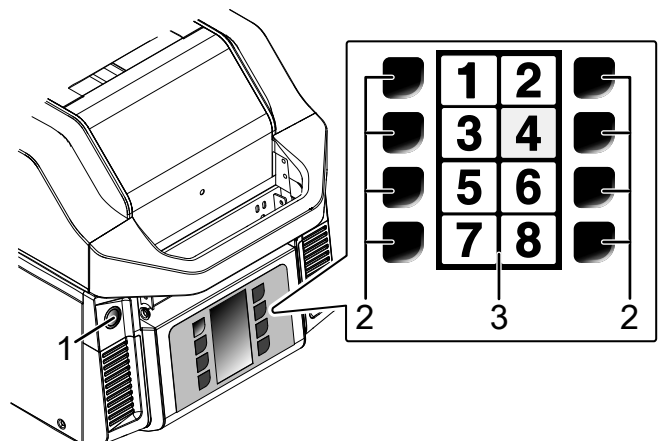

1	ON OFF button
2	Program selection buttons
3	Display

H.2.1 Display

The display is divided in 8 equal parts. Each part is linked to a program button.

When you press a program button the corresponding part of the display is on.

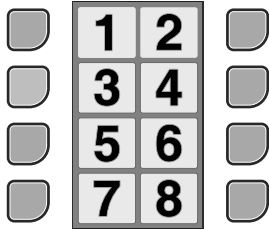

Fig. 1 Display structure



NOTE!

This display is not a touch screen. To select the desired program, press the relevant side button.

The appliance has 8 preset programs. To modify them refer to paragraph I.5 *Advanced settings*.

H.3 Non-stick tray

The tray allows to keep cleaner the appliance and reduce the cleaning time.



IMPORTANT

The tray is strongly recommended for use with this appliance.



You can also use a sheet of baking paper on the glass, to protect it from food residue.

Place the baking paper on the glass:



NOTE!

It is not necessary if you use the provided tray.

1. Clean the glass (refer to K.3.2 *Glass and lid*).
2. Lay the baking paper on the glass.

It must cover only the glass surface, do not exceed over the glass surface.

I OPERATING



WARNING

Refer to “Warning and safety information”.

I.1 Start up

Press the ON/OFF button to switch on the appliance.

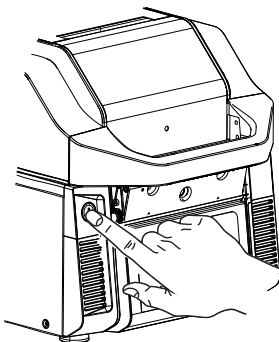

- The display shows first the “Welcome” screen;
- The lid opens automatically. The preheating takes about 20 minutes;
- During preheating, the appliance shows the QR code, which you can scan to register the product or access the documents you need;

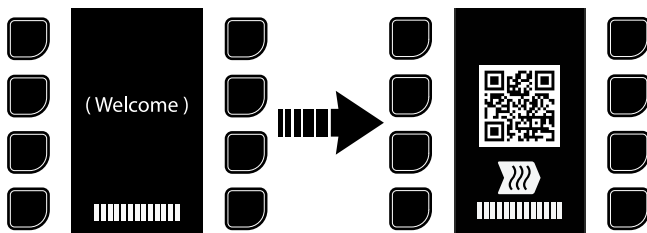

NOTE!

You can recall the QR code at any time by the programs page and pressing the button 1 and 3 at the same time for 2 seconds (refer to Fig. 1 *Display structure*) or by entering the setting menu with the

provided password and pressing the icon

- During this time, it is not possible to carry out any action.
- At the end of the preheating mode the display shows all the available programs.

The appliance is now ready to use.

I.2 Set a program

- To start the required program, close the lid and press the corresponding program button.

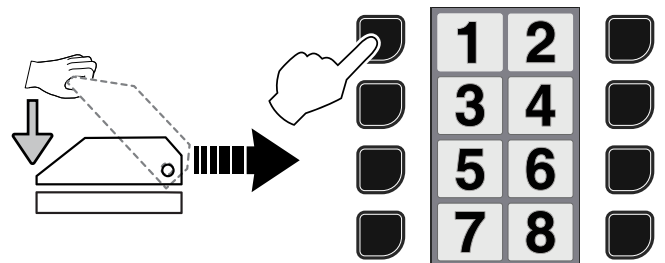

IMPORTANT

According to your model, the keyboard may be different. In this case, consider that the “3/4” button corresponds to number “3” and “S” button corresponds to number “4” while setting the programs.

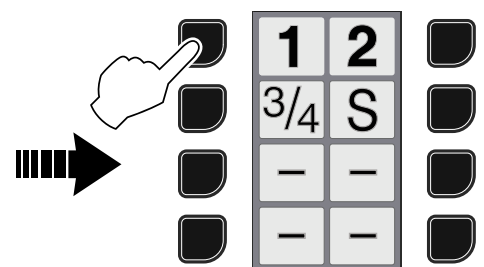

NOTE!

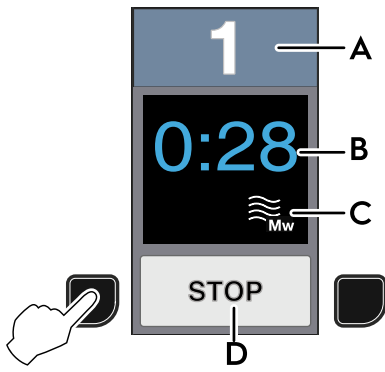

The symbol “-” means that the program was deleted. To set up a program enter a cycle duration. To delete a program, reset the cycle duration.

- When the cycle starts, the display shows the following information:



- A. Program number
- B. Program timer/countdown
- C. Microwave phase running
- D. Program STOP option (to be carried on by pressing the buttons "7" or "8" within 9 seconds).



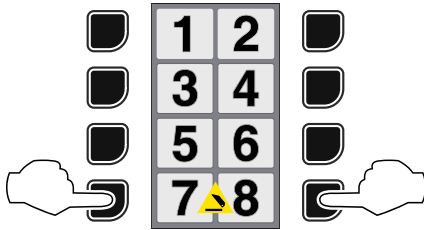

NOTE!
If you open the lid before the end of the program, the display shows the icon  and an acoustic signal sounds for 5 seconds. When the acoustic signal stops, the icon  remains visible, at bottom of the display.
To remove this icon press simultaneously the buttons "7" and "8" for 4 seconds. When the password menu activates enter the required password. The icon disappears.

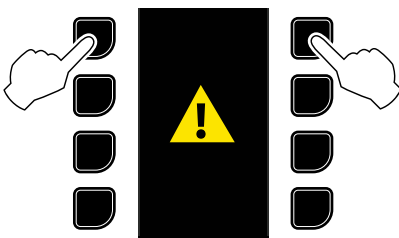

Yellow triangle icon

- When the display shows the yellow triangle icon switch the appliance OFF and ON.
- If the same icon shows up again on the display press simultaneously the buttons "1" and "2" for 4 seconds until an error code appears on the display. Inform the Service about the indicated error.



NOTE!
Pressing simultaneously the buttons "1" and "2" activates the alarm LOG on the display. Alarm events are recorded with date and time. Press the arrows buttons to scroll all the alarms.
Once selected the required event, press  button to display more information about the occurring problem.

Red triangle icon

- When the appliance is used for too long it may overheats. In this case the display shows a red triangle icon; wait for the overheated appliance to cool down.
- In some cases after cooling the display shows the text "Restart"; switch OFF and then ON the appliance.

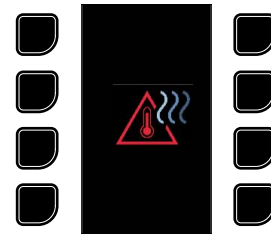

Stand-by

- After a certain time of inactivity (the time out is adjustable), the appliance switches automatically in stand-by status to save energy.
- During stand-by status, if the lid is closed the appliance shows the QR code, which you can scan to register the product or access the documents you need.



NOTE!
You can recall the QR code at any time by the programs page and pressing the button 1 and 3 at the same time for 2 seconds (refer to Fig. 1 *Display structure*) or by entering the setting menu with the provided password and pressing

the icon .

- If it is necessary to put the appliance in Standby before the time out press simultaneously the buttons "5" and "6".



NOTE!
It is possible that the buttons show dashes instead of numbers, in this case press the corresponding positions.

I.3 Basic set up settings

To access the "Basic Setting Menu" , you must insert a password.

1. Press simultaneously buttons "7" and "8" (or "-" and "-" , depending on the model) for two seconds until the password menu activates.

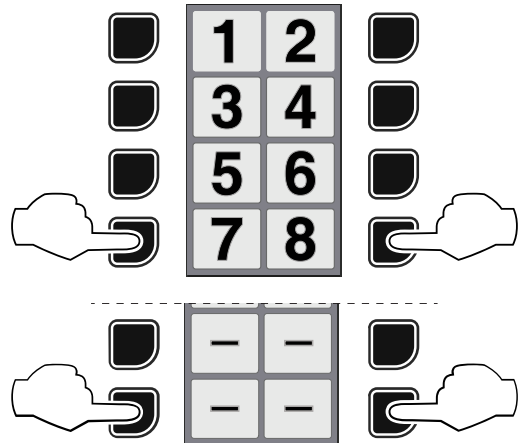

2. The default factory password is "1111". Press the corresponding buttons to insert the password.

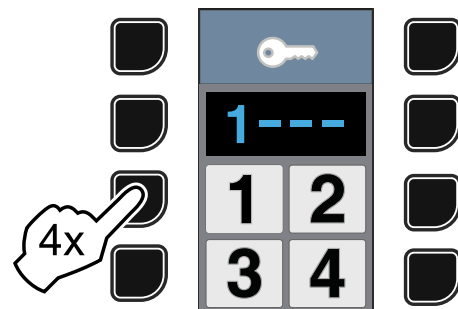



NOTE!
Only the Store Manager can access to the Basic settings.

If you want to change the password see I.5.13 *CHANGE PASSWORD* table in I.5 *Advanced settings* paragraph.

I.4 Basic settings

I.4.1 UPLOAD / DOWNLOAD APPLIANCE AND PROGRAM SETTING INTO / FROM USB KEY

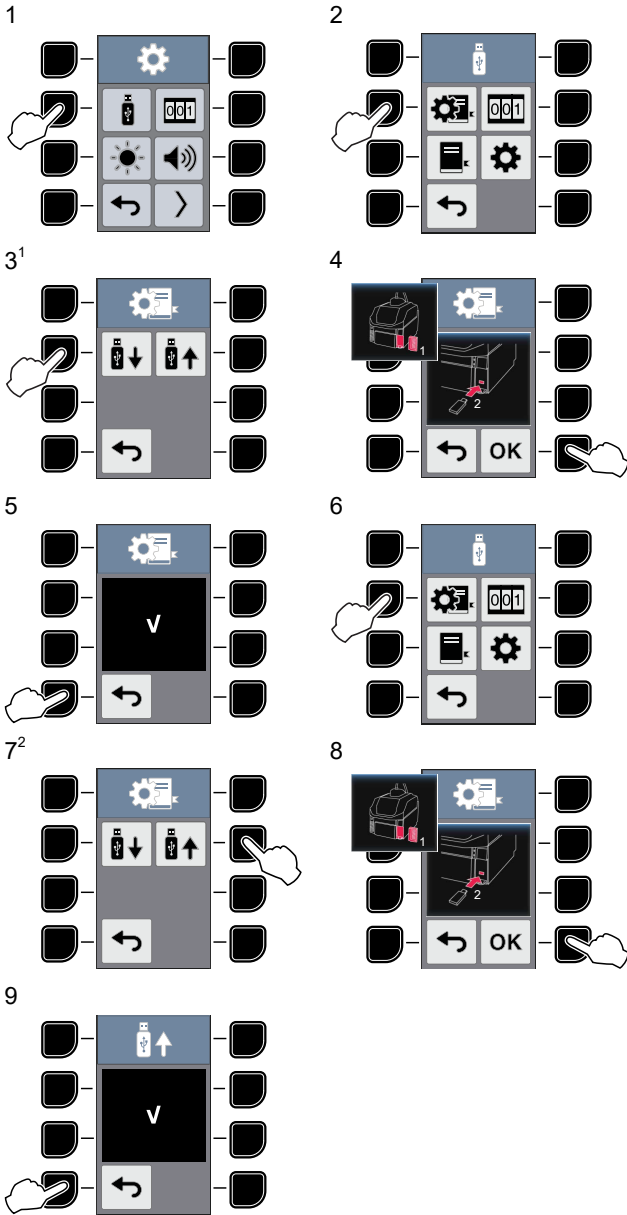

1. Download appliance settings into USB key.
2. Upload appliance settings from USB key.

I.4.2 DOWNLOAD LOG CYCLE INTO USB KEY

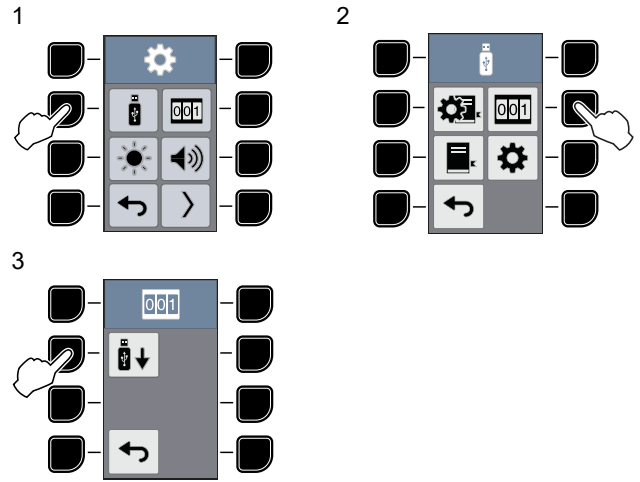

For the next steps, please refer to points 4 and 5 of I.4.1 *UPLOAD / DOWNLOAD APPLIANCE AND PROGRAM SETTING INTO / FROM USB KEY* table.

I.4.3 UPLOAD / DOWNLOAD PROGRAM SETTINGS INTO / FROM USB KEY

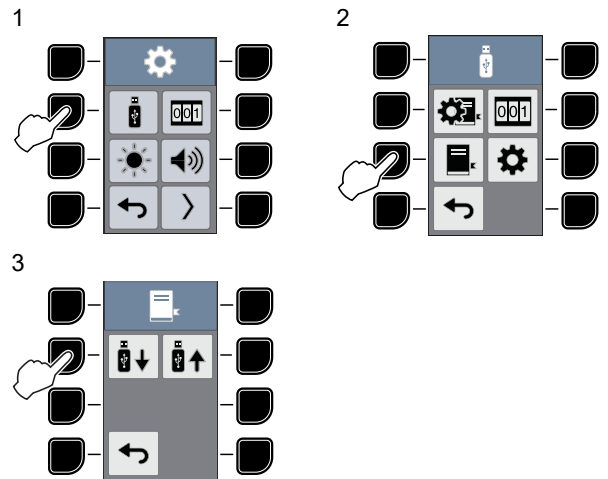

For the next steps, please refer to points 4 – 5 and to points 7 – 8 – 9 of I.4.1 *UPLOAD / DOWNLOAD APPLIANCE AND PROGRAM SETTING INTO / FROM USB KEY* table.

I.4.4 UPLOAD / DOWNLOAD APPLIANCE SETTINGS INTO / FROM USB KEY

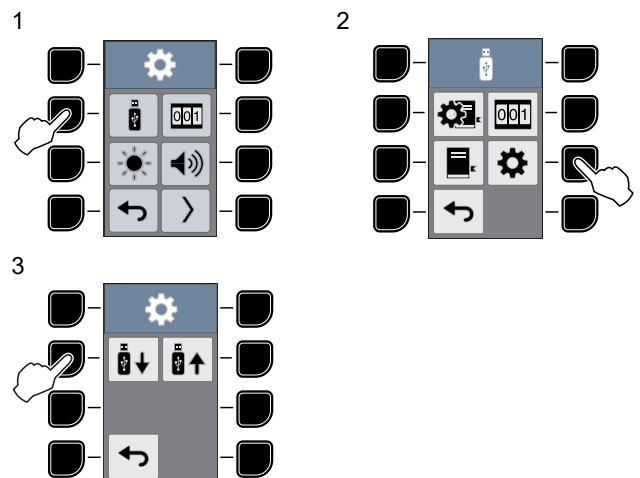

For the next steps, please refer to points 4 – 5 and to points 7 – 8 – 9 of I.4.1 *UPLOAD / DOWNLOAD APPLIANCE AND PROGRAM SETTING INTO / FROM USB KEY* table.

I.4.5 COUNTERS CONTROL

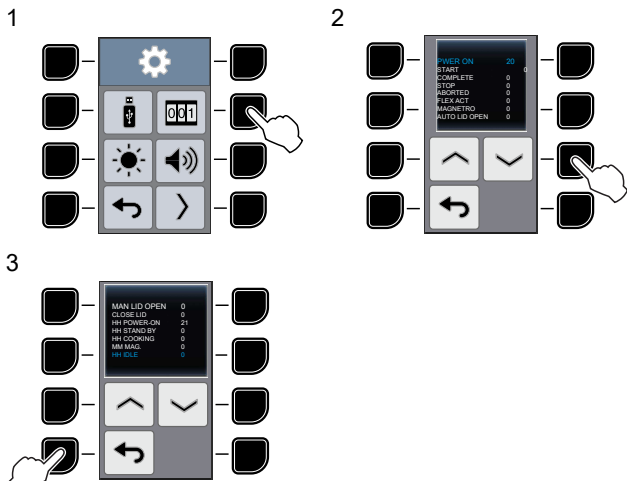

I.4.6 BRIGHTNESS

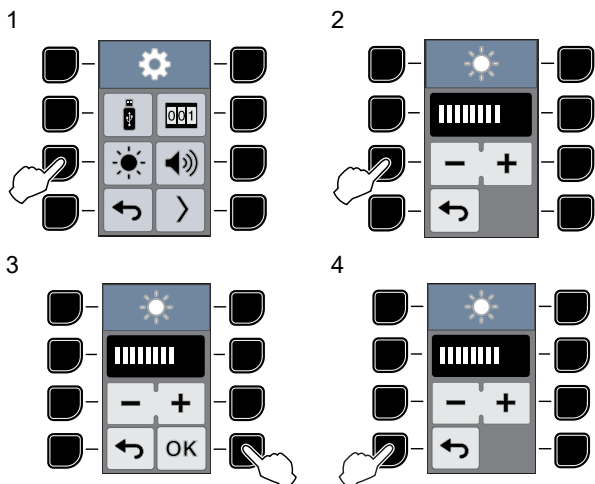

I.4.7 BUZZER SET UP

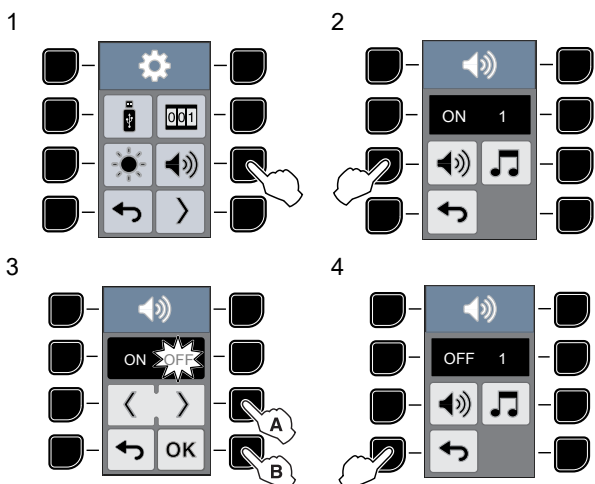

I.4.8 MELODY SET UP

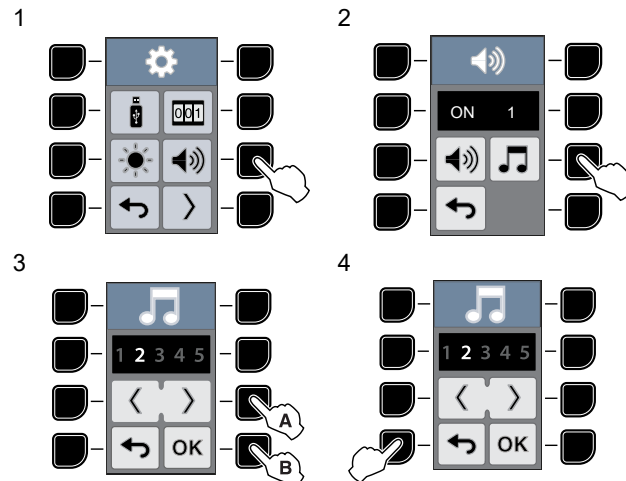

I.4.9 TIME SETTING

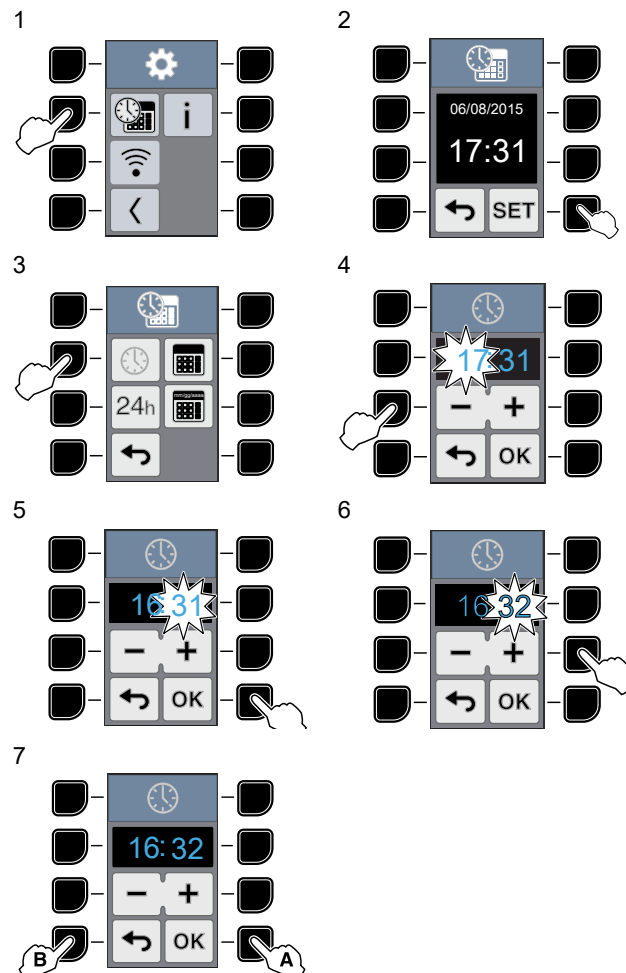

I.4.10 INFO DATA

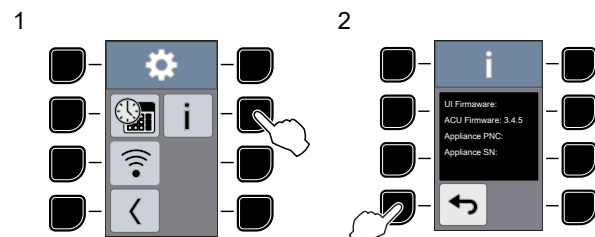

I.4.11 CONNECTIVITY

1

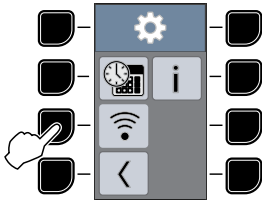

This function allows to connect the appliance to the Service remotely. The Service will be able to check any errors that may arise in the appliance.

2 SIGNAL CONTROL SELECTION

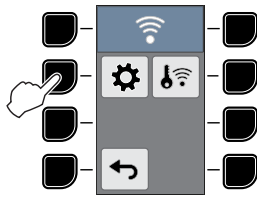

It is advisable to check the signal quality before putting the appliance in remote.

3 SIGNAL READING

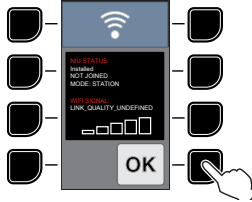

This screen displays the Wi-Fi signal power and the Connecting Board status. Confirm to exit.

4 REMOTE CONTROL ACTIVATION

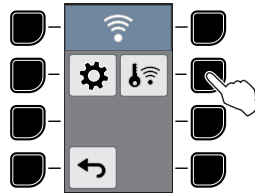

5 REMOTE CONTROL CONFIRMATION

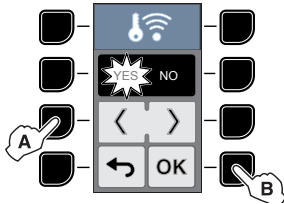

If it is necessary to interrupt the remote connection with the Service press simultaneously the buttons "7" and "8" and go straight to step 8 CONNECTION EXIT.

6 REMOTE CONTROL RUNNING

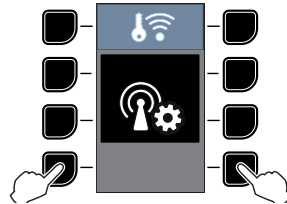

7 REMOTE CONNECTION ENDED

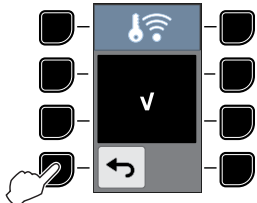

8 CONNECTION EXIT

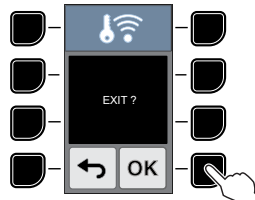

I.5 Advanced settings

I.5.1 Access to Advanced settings

To access the "Advanced Settings" , insert the required password.

1. Press simultaneously buttons "7" and "8" (or – and –) for two seconds to activate the password menu.

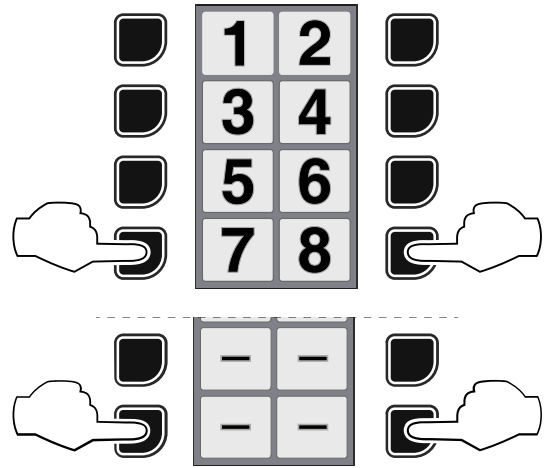

2. Press the corresponding buttons in the correct sequence to insert the password.

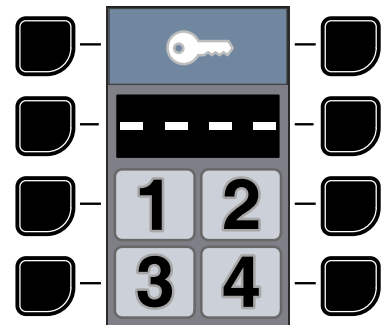

NOTE!

Only the Chef can access to the Advanced settings.

I.5.2 PROGRAM SETTING - Single Phase

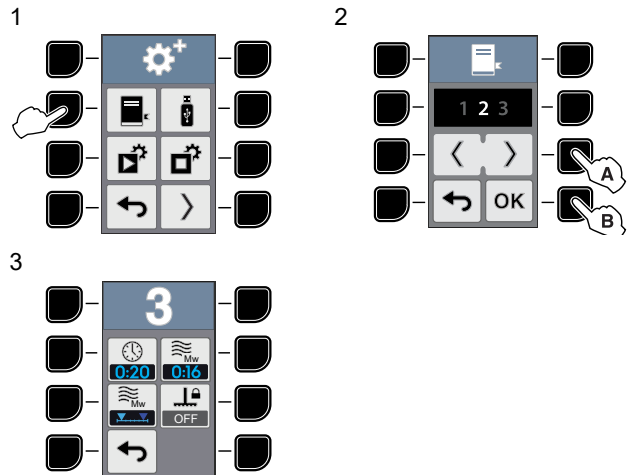

Full program duration

- Increase or decrease the full duration of the program.



Microwave phase duration

- Increase or decrease the full duration of the phase.



Set microwave starting

- You can set the microwave start at the beginning or at the end of the program.

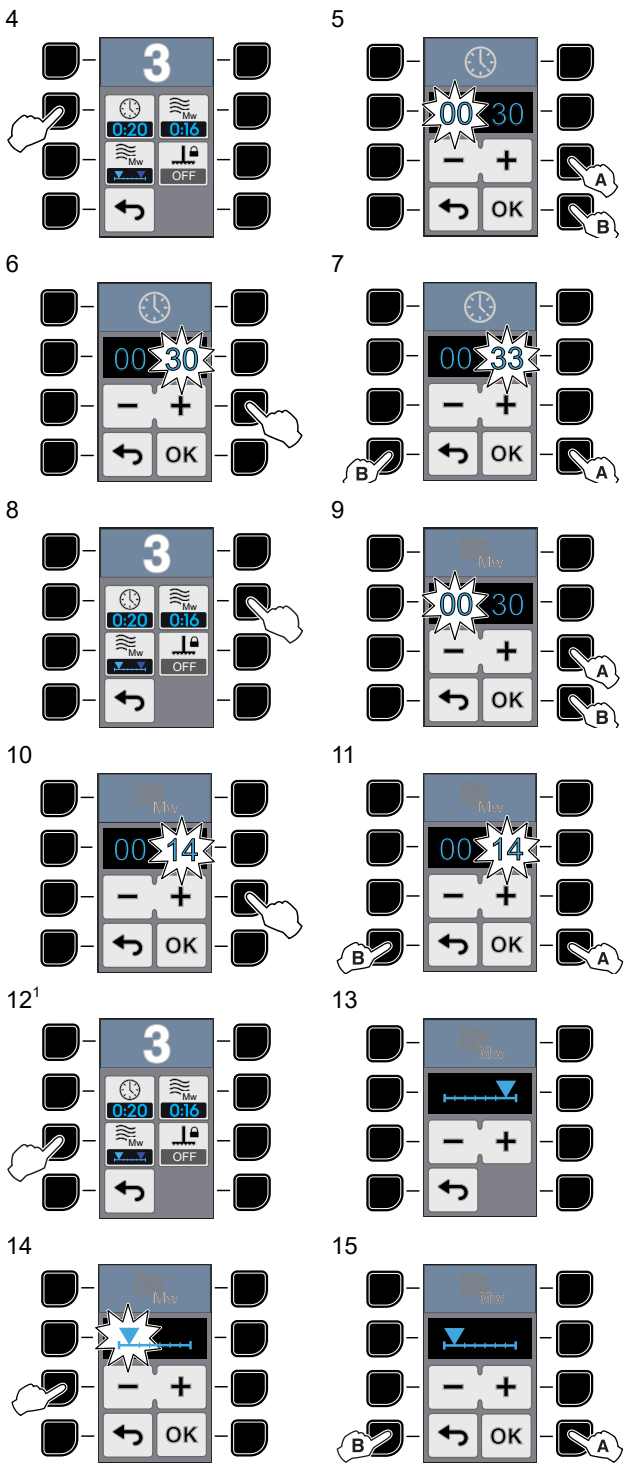

1. With this option, it is possible choose when the microwave phase starts (at the beginning or at the end of the cooking cycle).



WARNING

When setting the cooking cycle, it is recommended to select the minimum necessary microwave value in relation to the result you want to achieve on the sandwich.

In any case to ensure continuity of service in the case of rush hour service, we recommend NOT to exceed the following MW percentages in recipe composition according to your model:

Max amount of MW in %	Model
60%	200V - 230V models
75%	400V - 420V models
no limit	PEP Monomagnetron models

I.5.3 FLEX (models equipped only)

The Flex use allows you to cook food without being crushed by the upper plate. With this option, it is possible to adjust the Flex if the parameter is activated (models equipped only).

16 (models equipped only)

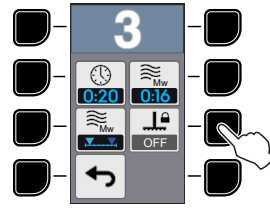

17

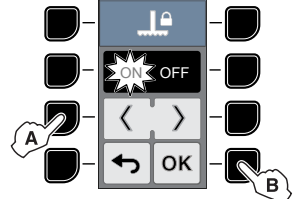

18 FLEX

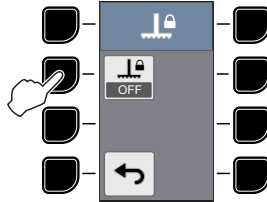

19 FLEX INSTRUCTIONS

With Flex ON the upper plate returns to the initial position at the end of the cooking cycle (models equipped only).

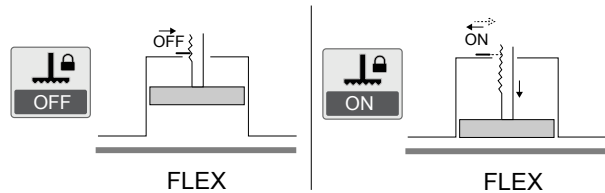

NOTE!

If necessary it is possible to lower the upper plate; press simultaneously the buttons "1" and "8" with the appliance only ready for cooking and displaying the following screen.

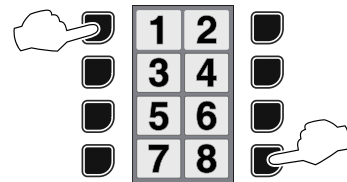

I.5.4 PROGRAM SETTING Multiphase

1

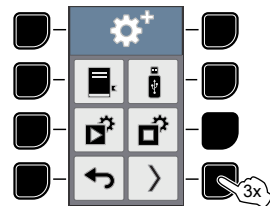

2

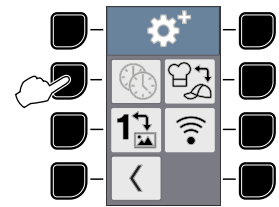

3

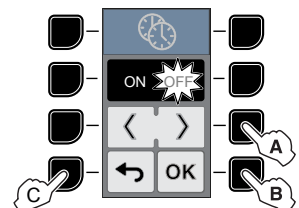

NOTE!

It is possible to activate the Mul-Phase if the parameter is enabled.

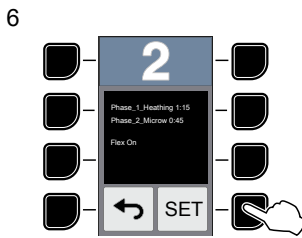
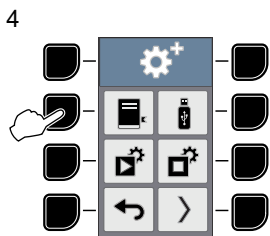

For the next steps, please refer to points 17 – 18 of I.5.2 PROGRAM SETTING - Single Phase table.

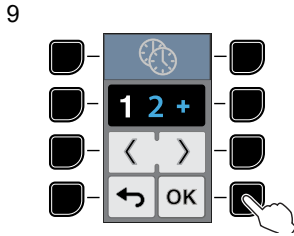

For the next steps, please refer to points 5 – 6 – 7 of I.5.2 PROGRAM SETTING - Single Phase table.

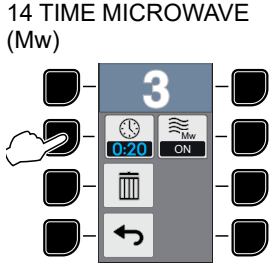
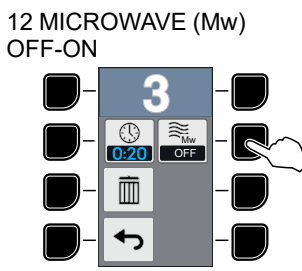

NOTE!
 In the Multiphase cycle the MW can be set only for one phase of the cycle (ON / OFF on the display).
 The MW duration time ranges from a minimum of 15 seconds to a maximum of 1 minute.
 The duration time of MW + plates = 4 minutes maximum.
 To eliminate the phase with the MW is necessary to set OFF and then reset the time.

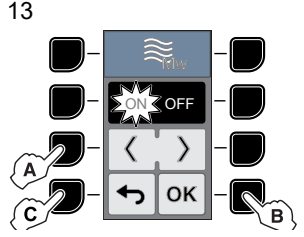
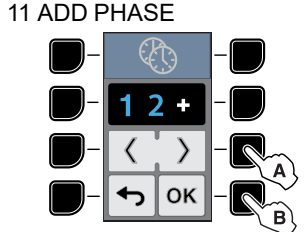
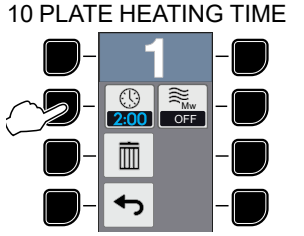
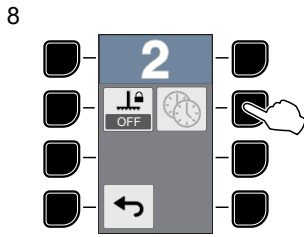
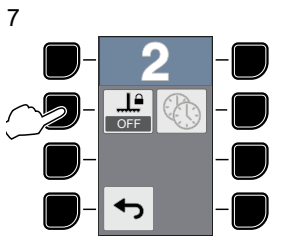
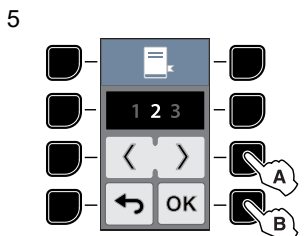

For the next steps, please refer to points 5 – 6 – 7 of I.5.2 PROGRAM SETTING - Single Phase table.

I.5.5 UPLOAD / DOWNLOAD APPLIANCE AND PROGRAM SETTING INTO/FROM USB KEY

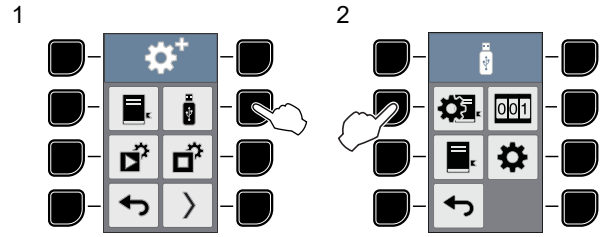

For their setting see I.4 Basic settings chapter.

I.5.6 START MODE SETTING

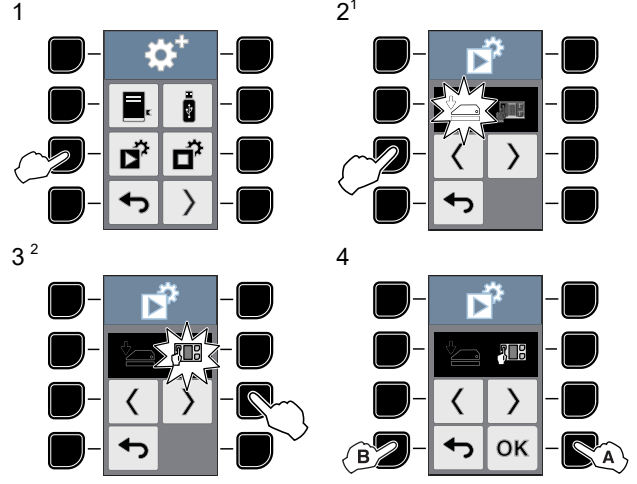

1. With lid closed, the cooking program starts.
2. When you press the required program, the cooking program starts.

I.5.7 STOP CYCLE OPTION SETTING

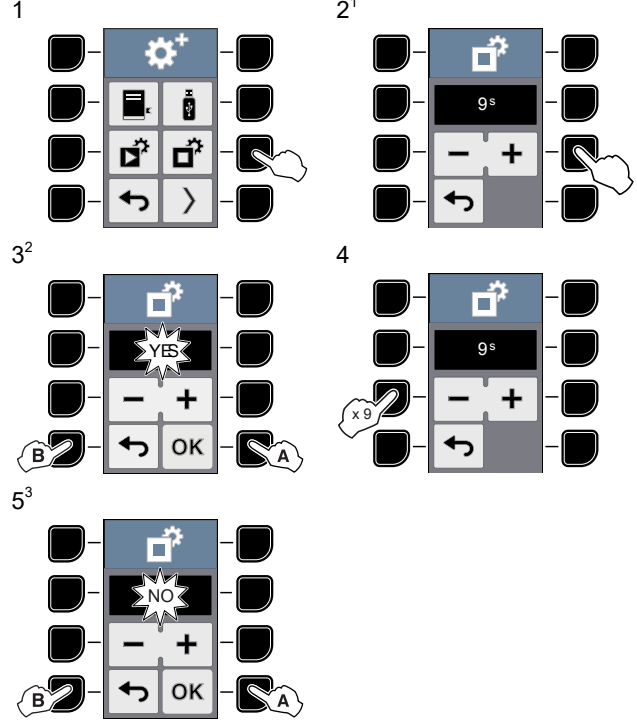

1. Appearance time of STOP button (from 1s to 9s).
2. STOP option available on the display.
3. STOP option unavailable on the display.

I.5.8 UPPER PLATE AND GLASS TEMPERATURE SETTING

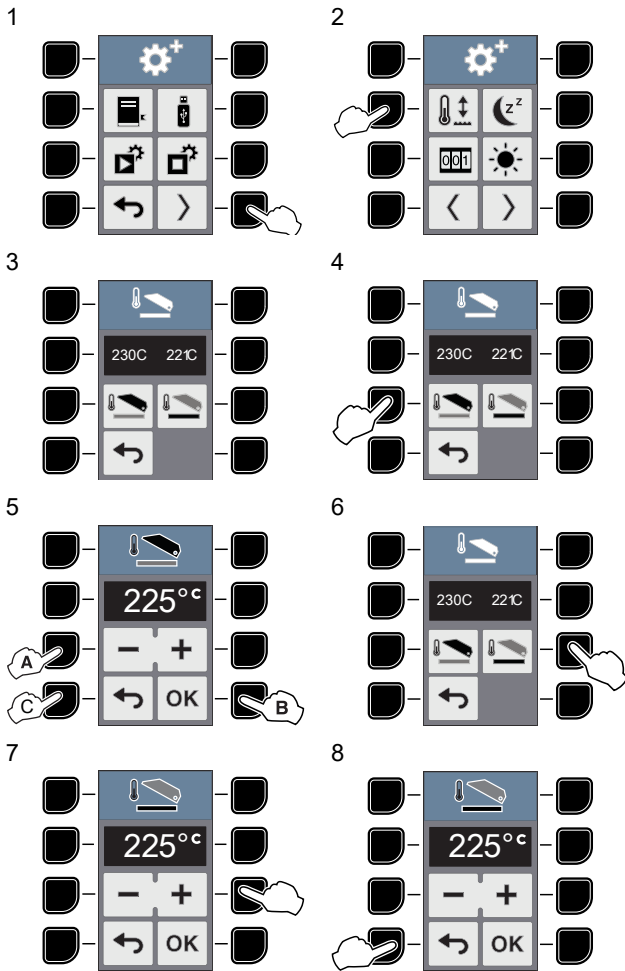

NOTE!
Once the temperature of the glass and the upper plate are set, all stored programs will run at those temperatures; you cannot specify different temperatures for each individual program.

I.5.9 STAND-BY SETTING

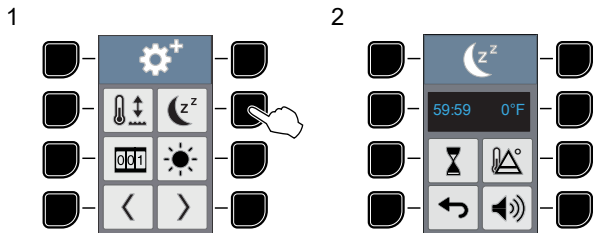

Stand-by time

- You can set the "Stand-by" up to 59 minutes and 59 seconds.



Upper plate and glass temperature during Stand-by

- During the "Stand-by" you can set the upper plate and the glass up to 80°C or 176°F less than the operating temperature.

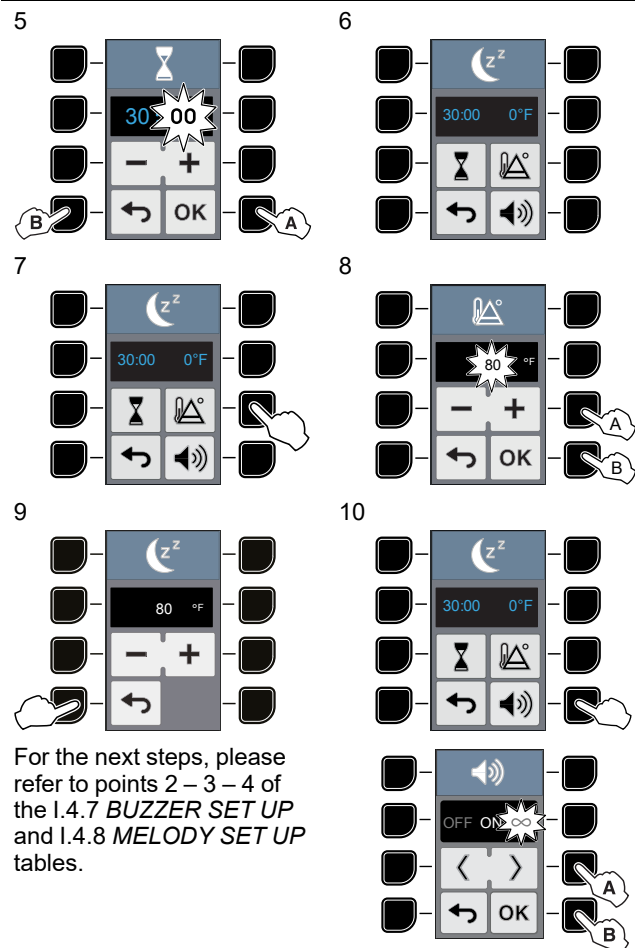
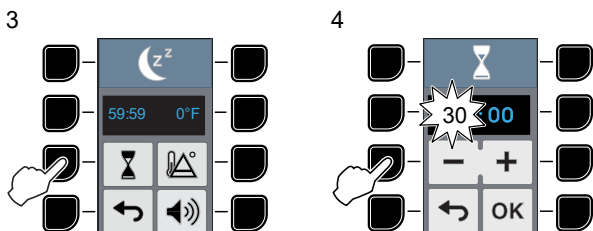

For the next steps, please refer to points 2 – 3 – 4 of the I.4.7 **BUZZER SET UP** and I.4.8 **MELODY SET UP** tables.

I.5.10 COUNTERS CONTROL

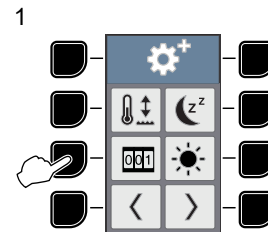

For its setting see I.4.5 **COUNTERS CONTROL** section described in I.4 **Basic settings** chapter.

I.5.11 BRIGHTNESS

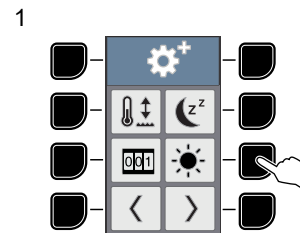

For its setting see I.4.6 **BRIGHTNESS** section in I.4 **Basic settings** chapter.

I.5.12 BUZZER SET UP – TIME SETTING – INFO DATA

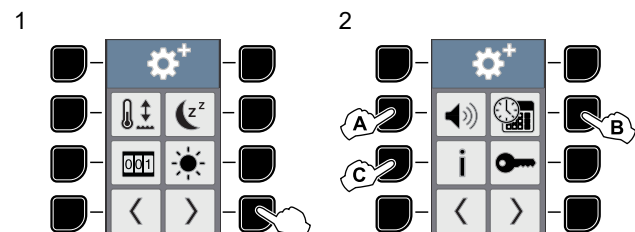

A BUZZER SET UP

- Please see I.4.7 **BUZZER SET UP** table in I.4 *Basic settings* chapter.

B TIME SETTING

- Please see I.4.9 **TIME SETTING** table in I.4 *Basic settings* chapter.

C INFO DATA

- Please see I.4.10 **INFO DATA** table in I.4 *Basic settings* chapter.

I.5.13 CHANGE PASSWORD

1

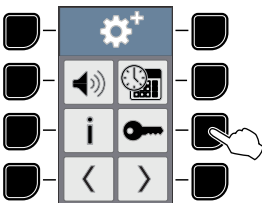

2 BASIC SETTINGS

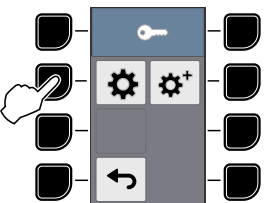

3

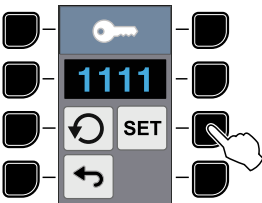

4¹

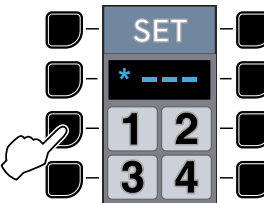

5 ADVANCED SETTINGS

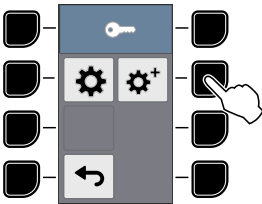

6 ADVANCED SETTINGS

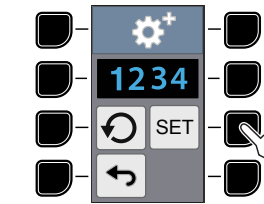

7¹

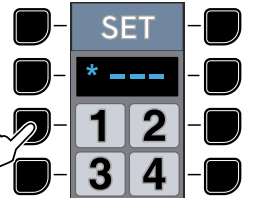

1. Insert 4 digit to set a new password.

I.5.14 RESET PASSWORD

1

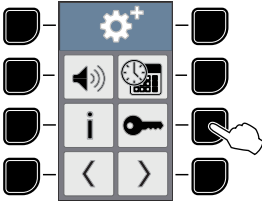

2 BASIC SETTINGS

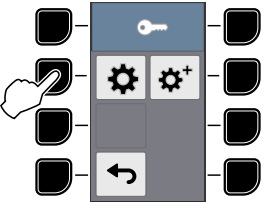

3

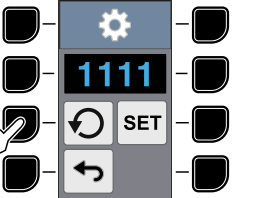

4

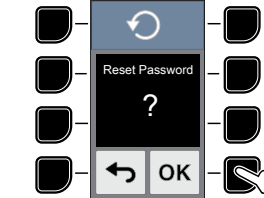

5 ADVANCED SETTINGS

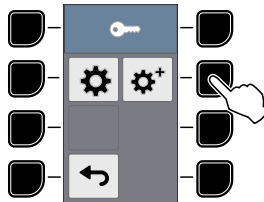

6

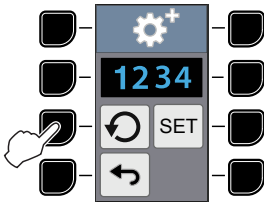

7

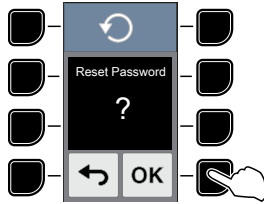

I.5.15 EXPERT - UNEXPERT SETTING

1

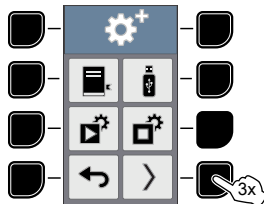

2 EXPERT/UNEXPERT SELECTION

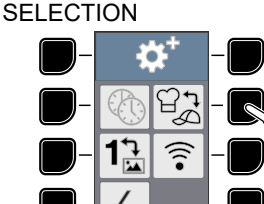

3 EXPERT/UNEXPERT SETTING

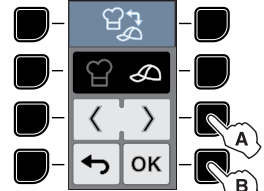

UNEXPERT mode becomes useful when switching from FLEX ON program to FLEX OFF one and viceversa.

In the first case after a FLEX OFF program (before it was

set ON), the icon  appears in order to advice to raise the plate. Raise the plate and press the OK button to confirm.

i NOTE!
If the OK button is not pressed, the lid opens again.

In the second case after a FLEX ON program (before it was

set OFF), the icon  appears in order to advice that the plate lowers automatically.

i NOTE!
EXPERT mode does not provide any action, except for lowering automatically the plate when the operator forgets to do it.

I.5.16 IMAGE MENU SETTING

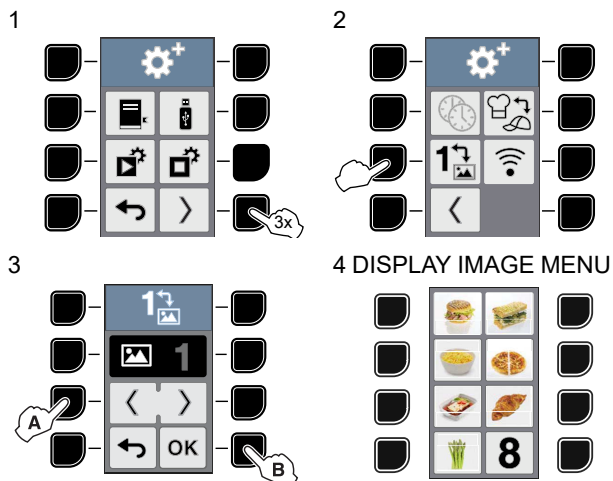

In this mode the program numbers are replaced by IMAGES that can be uploaded in the appliance from an USB key.

To upload the IMAGES:

1. Switch the appliance OFF.
2. Insert the USB key with the IMAGES file.
3. Switch the appliance ON.

Create the IMAGES file with the special program "Menu Icons Editor" in the area "My Professional" at the following WEB site:

<https://electroluxprofessional.com> (to enter this site you need to register).

I.5.17 CONNECTIVITY SETTING

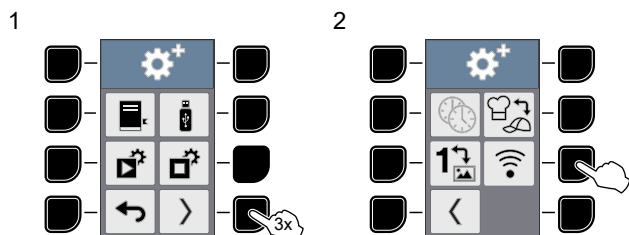

This function allows to connect the appliance to the Service remotely. The Service will be able to check any errors that may arise in the appliance.

For this function, see the steps described in the I.4.11 CONNECTIVITY paragraph in I.4 Basic settings chapter.

I.5.18 RECIPES MANAGEMENT FROM CLOUD (if available in your model)

This function allows to receive/send recipes from/to cloud once the appliance is connected remotely.

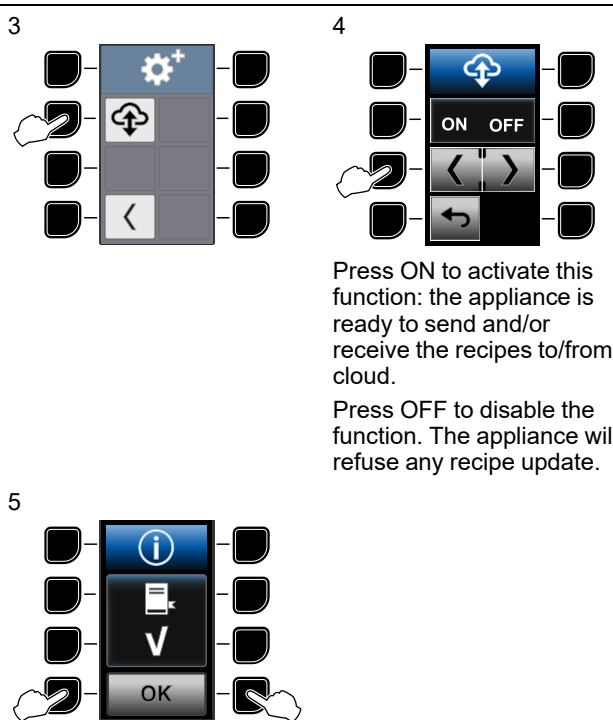
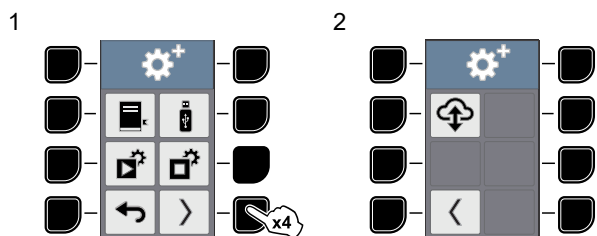

Press ON to activate this function: the appliance is ready to send and/or receive the recipes to/from cloud.

Press OFF to disable the function. The appliance will refuse any recipe update.

This pop up informs that some recipes have been updated remotely. Press button "7" or "8" to confirm. There is no possibility to refuse the update.

I.6 Daily use



CAUTION

Starting a cycle without a sandwich can cause malfunction and damage to the appliance.





WARNING

Risk of burning. The glass and the upper heating plate are hot.

1. Place the sandwich on the glass or on the tray making sure that the sandwich/tray is fully under the upper heating plate.
2. Close firmly the lid.
3. Press one of the "8" program buttons to set the required cycle.
4. At the end of the program, you can hear an acoustic signal:
 - The display shows a message about lid opening.
 - The lid opens automatically.
5. Remove the sandwich from the glass or the tray by means of the delivered plastic spatula (ANC 653625) or similar tool.



IMPORTANT

With intensive use of high microwave cycles the appliance may overheat and the symbols  and  could appear: leave the lid open, remove the tray and wait a few minutes for the screen with programs to reappear on the display.



NOTE!

To interrupt the cycle press the buttons "7" and "8" or open the lid within 9 seconds after the program start. To restart the appliance again close the lid and select a program again.

**CAUTION**

- Pay attention when the lid is opening, do not block the lid movement.
- Cooking surfaces are strong but not unbreakable and can be damaged by hard or sharp objects if falling on the top with a certain force.
- Do NOT use the appliance in the event of breaks, flaws or cracks.

**CAUTION**

As in any Microwave appliance, it can occur to have sparks inside the cooking chamber. These sparks do not influence the safety of the user nor the appliance nor the quality of the sandwich. If, as a consequence of the sparking, a dark mark on the metal parts is visible, this can be cleaned with a damp cloth.

**IMPORTANT**

Risk of overcooking. The glass and the upper heating plate are heating also when the lid is opened. Do not leave the sandwich on the glass long before and long after the cooking cycle.

**CAUTION**

Press the control panels buttons only with the fingers.

J REMOVABLE TEFLON PLATE (RTP)**J.1 Precautions for use****CAUTION**

Carefully follow these instructions on using the Removable Teflon Plate (RTP) in order to ensure the proper operation and service life of the appliance.

The Removable Teflon Plate can be used on both sides. Each side can be used up to about 2500 cooking cycles.

- To ensure durability, clean both sides because the hidden side also can get dirty during use.
- We suggest a consecutive use of the same side, until 2500 cycles are reached, before starting to use the other side.

The RTP is fixed to the top heating plate by means of 4 clips. To reach these clips, the upper heating plate has to be removed. Proceed as described here below.

**WARNING**

The upper heating plate and the glass can be hot. Make sure to fix the RTP only when the top heating plate is cold. If not, use protective gloves for high temperature.

J.2 Unlock the upper plate**NOTE!**

Switch off the appliance and unplug the power cable.

1. Open the lid and put the silicon protector "A" on the glass to avoid damaging it.
2. Unlock the upper heating plate by pushing the unlocking nut backwards "B".

3. Help the descent of the upper heating plate by guiding the flexible tube "C".

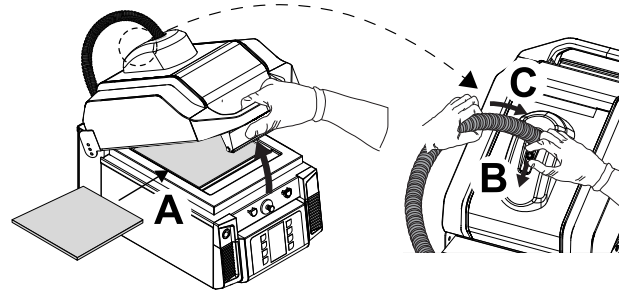

4. The upper plate must be placed exactly on top of the silicone protector and must not be rotated during the descent.

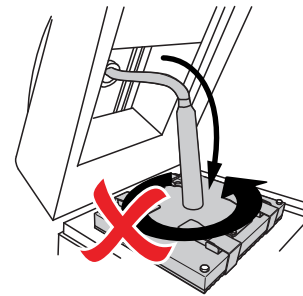

The RTP fixing clips are visible on the upper part of the top heating plate.

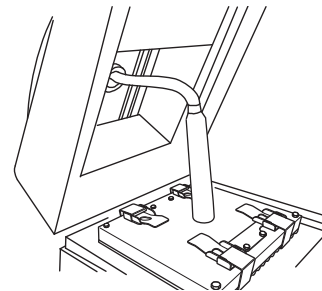

J.3 Replace the Removable Teflon Plate

1. Just release the 4 clips and remove the RTP, replace it.

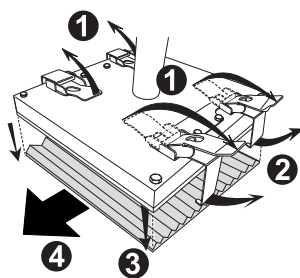

2. Place the replaced RTP on the clean upper plate with the grooves in the same direction and secure it with the 4 clips.

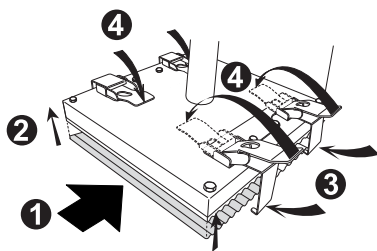

NOTE!

Make sure to fix the RTP only when the upper heating plate is clean.



IMPORTANT

It is advisable to purchase 2 RTPs in order to have one always available for immediate replacement if the other is worn from use.

J.4 Fix the upper plate in the lid

1. Fit back the upper plate in the lid respecting right position of the upper heating plate. Have high care not to turn the upper heating plate that would provoke flexible hose damages (the symbols must be in the front).

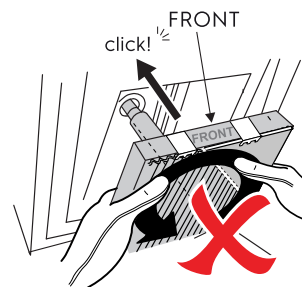

2. Guide the flexible tube to avoid damages.

A segment is permanently marked along the length of the tube: be sure to keep this segment in a straight line to ensure proper repositioning of the top plate and to avoid damaging the tube and wiring.

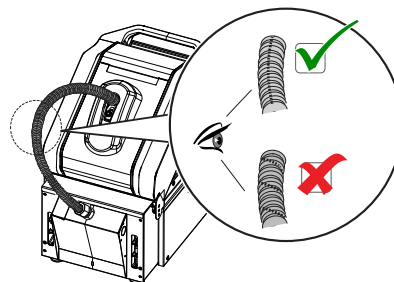

K APPLIANCE CLEANING

K.1 Cleaning introduction



WARNING

Use heatproof gloves when operating with hot parts.

In order to reduce the environmental impact of pollutants it is advisable to clean the appliance (externally and, where necessary, internally) with products that are more than 90% biodegradable.



CAUTION

- Do not use solvent-based detergents (e. g. trichloro-ethylene) or abrasive powders for cleaning.
- Do not use chemical products such as sodium hypo chlorite (bleaching powder), hydrochloric acid (muriatic acid) or other acids to clean the surfaces of the appliance.
Do not use the above products even for cleaning zones next to the appliance, their vapours can damage it.
- Do not use steel brushes, steel wool, copper cloths, sand-based or similar products for cleaning.
- Do not use any razor blade or metallic tool on the tray (if present) and glass, they will be damaged.



WARNING

When using chemicals, comply with the safety notes and dosage recommendations printed on the packaging. Refer to the chapter *A.2 Personal protection equipment* for handling chemical products.



IMPORTANT

- While using the appliance grease and carbon deposit can be burnt by the microwave; remove all the debris in the cooking area, risk of lighting!
- Never immerse cords, plugs or appliance in water.

K.2 External cleaning



NOTE!

To easily clean the appliance, remove the dirty when it has just formed.

- Clean both sides and the rear of the appliance. Take care not to introduce water into the appliance through the openings.
- In case of encrusted dirt, grease or sandwich residue, use a cloth/sponge wiping with the grain of the satin finish and rinse often.
- Rubbing in a circular motion combined with the particles of dirt on the cloth/sponge could damage the steel's satin finish.

K.3 Daily cleaning

K.3.1 Preliminary actions



CAUTION

Perform the cleaning with the appliance in high temperature to guarantee the efficiency of the cleaning product.



WARNING

Refer to “*Personal protection equipment*”.

1. Remove the tray from the appliance and follow the instruction given in paragraph K.3.5 *Food tray cleaning*, once you have completed cleaning the appliance.
2. Switch the appliance OFF and unplug the power cable.
3. Open the lid and allow the appliance to cool down 7 minutes before proceeding.

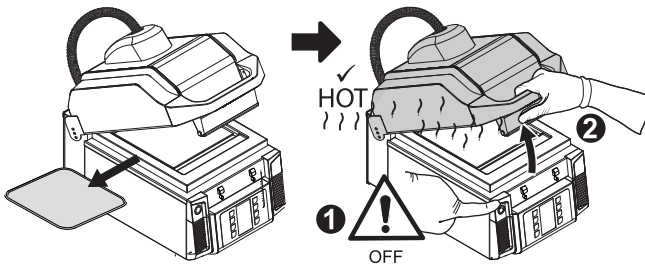

K.3.2 Glass and lid

4. Place a piece of paper in the gap between the working top and the lid to prevent food debris from getting into it.

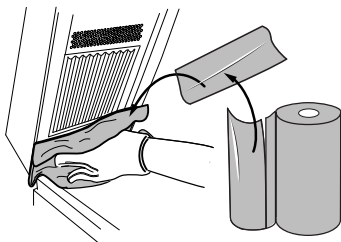

5. Pour the specific degreaser over the glass and spread it over the entire surface with the brush for at least one minute to allow the product to activate.



IMPORTANT

- The glass must be hot to achieve an effective degreasing action.
- Continue stirring the product until it gets darker and stops bubbling.

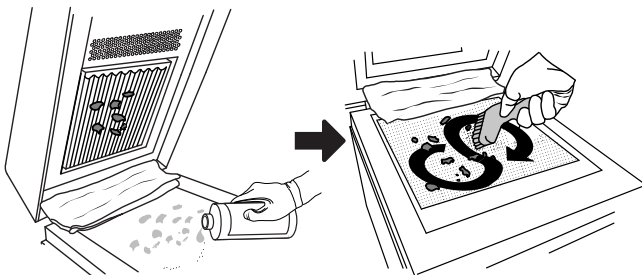

CAUTION

Be very careful not to damage the silicone sealing to prevent grease or dirt from seeping in.

6. Spread the specific degreaser used before on the glass, also on the upper plate using the brush.



CAUTION

Never spray the specific degreaser directly onto the plate.

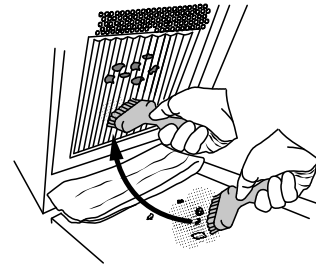

7. Scrub the upper plate with the brush.



8. Wipe with paper to remove detergent and dirt residue.

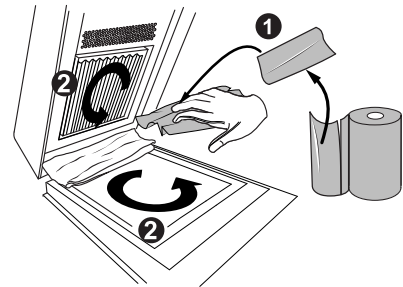

9. Rinse with a damp cloth:
 - the glass and the working top,
 - the upper plate,
 - the lid.

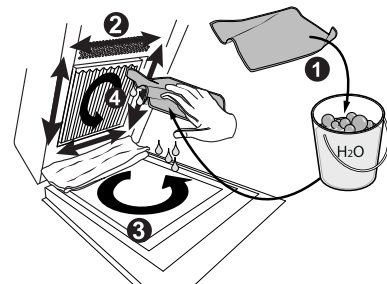

K.3.3 Choke or choke cover cleaning

If the lid of your model has the following structure, perform choke cleaning, refer to K.3.3.1 *Choke cleaning*.

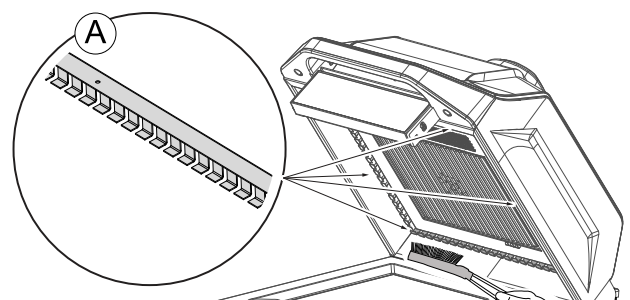

Otherwise, perform the *Choke cover cleaning* as shown below.

Choke cover cleaning

- Wipe the choke cover with a cloth and rinse using another damp cloth. Ensure removal of any grease or food residue to prevent early failure due to charring effect.



IMPORTANT

Pay attention not to dent, scratch, cut or otherwise damage the choke cover, its surface and the silicon around it: this will result in shorter life span of the component. Use only soft wet clothes.

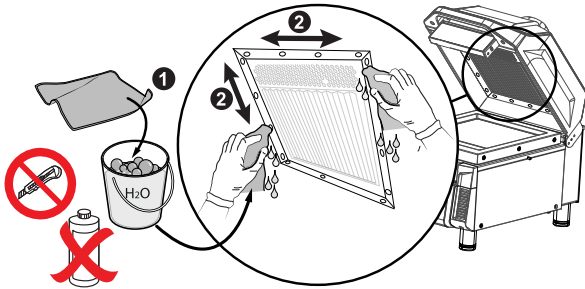

K.3.3.1 Choke cleaning



CAUTION

Do not use detergents or chemicals for cleaning the choke.



IMPORTANT

- Clean the choke only with the supplied brushes.
- Use cut-resistant protective gloves.

- Put a cloth-paper on the working top to protect it.
- Use the brass bristle brush to remove any food incrustations.

Clean the choke by carefully rubbing the brush in two different directions, as shown in the figures.

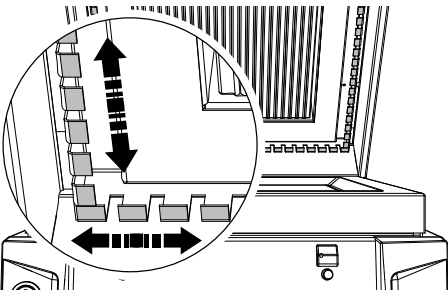

- Then, use the nylon bristle brush to remove cleaning residues.

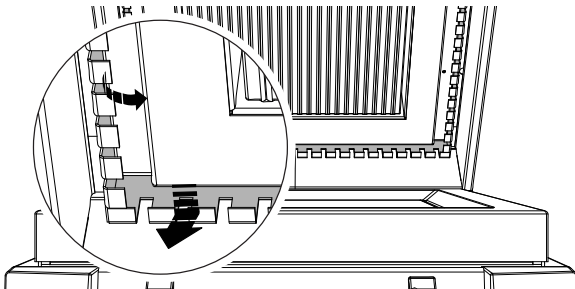

Ensure the complete removal of any grease or food residual to prevent carbonization effect.



IMPORTANT

Do not deform the choke gills. In case of deformation, suspend the use of the appliance and contact the Customer Care Service.

- Remove the cloth-paper from the working top.

K.3.4 Cooking chamber

- Push the upper plate to the highest point until it locks.

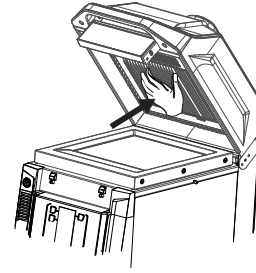

- Clean the cooking chamber with a damp cloth.

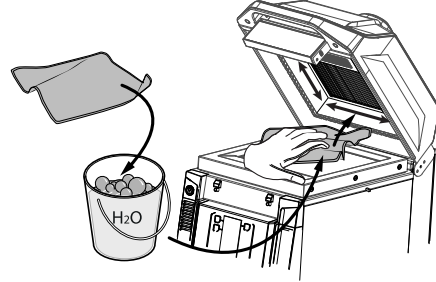

- Finally remove dirt and food residues from the rear slot between the working top and the lid by sliding the paper.

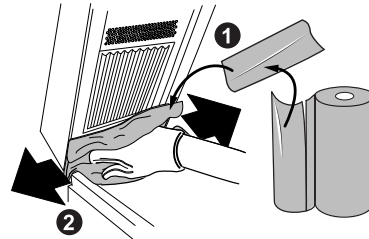

K.3.5 Food tray cleaning

The tray coating material is easily cleaned but the tray life is greatly determined by its handling and care.

Refer to the instructions enclosed with the tray.

- Wipe the tray with a damp soft cotton cloth (or dish towel), neutral detergent and warm water. Do not use scrubbing pads, scrapers or any hard brushes to remove the grease and burned deposit.



- Shake off the excess of water and lay flat to dry. Do not submerge or soak the tray in water.



CAUTION

Do not place the tray in dishwashers. Never cut or use sharp metallic tools on the tray surface. Never scrape the special tray coating off of the substrate. Do not fold the tray.

K.3.6 Steam exhaust chamber

19. Close the lid and unscrew the front knob to remove the front top cover.

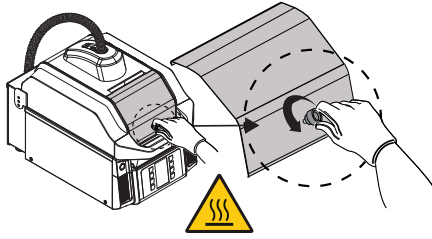

20. Using a damp cloth or a sponge soaked with the detergent, clean both the steam exhaust chamber and the inside of the front top cover.

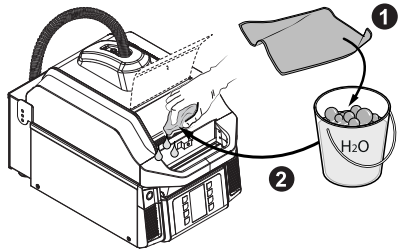

21. Fit back in place the front cover and secure it by screwing the knob before using the appliance.



IMPORTANT

Before using the appliance, be sure to have re-installed properly the front top cover; Check the complete cleanliness before re-installing the front top cover. Be sure that there is nothing (cloth, sponge, paper towel ...) left inside the steam evacuation chamber.

For FLEX versions only

- At the end of the cleaning process, after having turned the appliance back on, when the preheating phase is completed, it is possible to reactivate the FLEX function (automatic adjustment of the top plate) by pressing buttons "1" and "8" simultaneously.

K.4 Weekly cleaning

Once a week perform all steps of the *Daily cleaning* in the order listed above until the cooking chamber cleaning is complete, refer to K.3.4 *Cooking chamber*. After that, proceed as follows:

K.4.1 Clean the Removable Teflon Plate

1. Unlock the upper plate, referring to paragraph J.2 *Unlock the upper plate*.
2. Open the clips of the RTP.

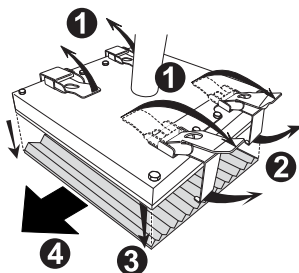

3. Spray the RTP over both sides with a soft detergent.

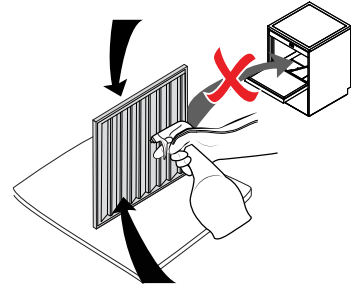

NOTE!

If the plate is very dirty, it is recommended to soak it for a few minutes and then clean it

4. Scrub the RTP with the provided brass bristles brush
5. Wipe the RTP with a cloth-paper and rinse it with a new wet cloth-paper.
6. After cleaning, place the RTP under the upper heating plate and secure it closing the clips.

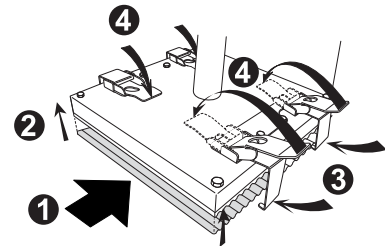

K.4.2 Cooking chamber deep cleaning

1. Place a piece of paper in the gap between the working top and the lid; use more paper to completely cover/protect the top plate.



IMPORTANT

Do not use detergent on newly placed paper.



2. Spray a degreaser all inside the cooking chamber. Allow to soak for 1 minute.

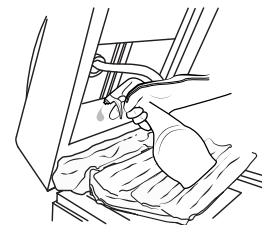

3. Wipe with paper to remove detergent and dirt residue.

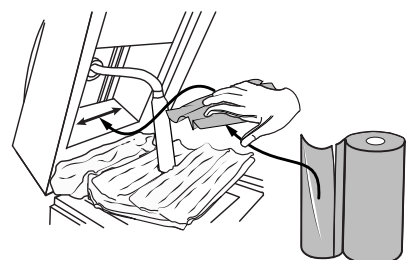

4. Rinse with a damp cloth.



5. Remove the protective paper from the upper plate.
6. Fit back the upper plate by referring to paragraph J.4 *Fix the upper plate in the lid.*

K.4.3 Filters cleaning

7. Use a Phillips screwdriver (type PH1 or PH2) to unlock the left and right front bezels.
8. Gently lift the bottom of the covers and slide them downwards.
9. Remove the filters from the masks and carefully clean them from grease, crumbs and dust, then dry the filters.
10. Separately clean the masks eliminating any deposits deposited in the ventilation grooves, especially from the inside, then dry the masks carefully.

11. Use a vacuum cleaner to remove any dirt or dust from the left and right front louvers prior to reposition the bezels.

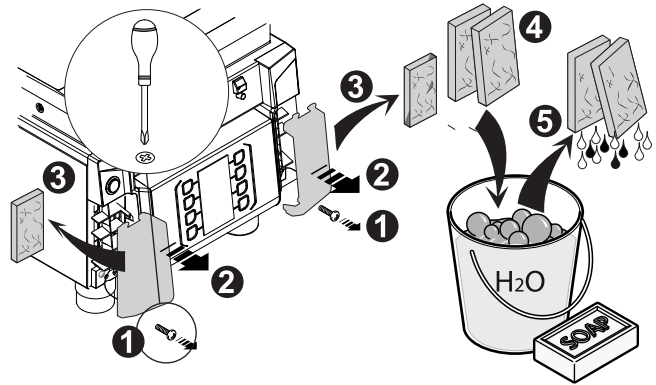

12. Reposition the dry filters in the masks and gently insert them into the front until they adhere to the edges.

13. Tighten the screws to fix the covers.

Then continue with the steps of daily cleaning with the cleaning of the tray, refer to K.3.5 *Food tray cleaning* and then with the cleaning of K.3.6 *Steam exhaust chamber*.

L APPLIANCE MAINTENANCE



WARNING

Refer to “*Warning and safety information*”.

L.1 Care information

Care operations have to be carried out by the owner and/or user of the appliance.



IMPORTANT

Problems resulting from poor or lack of care as hereinafter described will not be covered by the warranty.

Intensive use of the appliance can lead to situations where the limit of use is reached prematurely. Therefore in case the upper plate, the upper plate flex or the lid have difficulty in automatically disengaging, we suggest to lubricate the points as indicated in the following pictures.

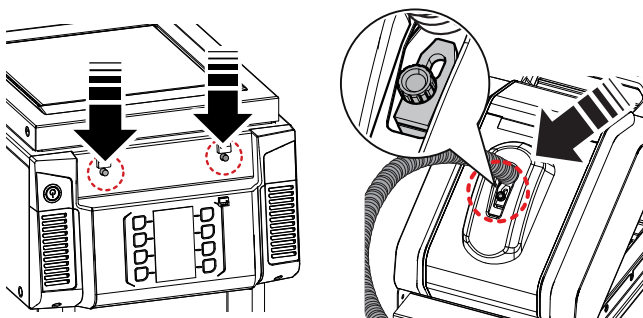

L.4 Maintenance intervals

It is advisable to carry out the checks with the frequency given in the following table:

L.2 Decommissioning

If the machine cannot be repaired, carry out the decommissioning operations, signalling the failure with a suitable sign, and request assistance of the manufacturer's Customer Care service.

L.3 Disassembly

If the appliance has to be disassembled and then reassembled, make sure the various parts are assembled in the correct order (if necessary mark them during disassembly).

Before disassembling the machine, make sure to carefully check its physical condition, and in particular any parts of the structure that can give or break. Before starting disassembly:

- disconnect the power supply;
- place a sign on the Main Electrical Panel indicating that the machine is undergoing maintenance and not to carry out manoeuvres;
- enclose the work area;
- remove all the pieces (if present) in the machine;
- carry out the disassembly operations.

Maintenance, inspections, checks and cleaning	Frequency	Responsibility
Ordinary cleaning <ul style="list-style-type: none"> • general cleaning of appliance and surrounding area 	<ul style="list-style-type: none"> • Daily 	<ul style="list-style-type: none"> • Operator
Mechanical protection devices <ul style="list-style-type: none"> • check their condition and for any deformation, loosening or removed parts 	<ul style="list-style-type: none"> • Monthly 	<ul style="list-style-type: none"> • Service
Control <ul style="list-style-type: none"> • check the mechanical parts, for cracks or deformations, tightening of screws: check the readability and condition of words, stickers and symbols and restore if necessary 	<ul style="list-style-type: none"> • Yearly 	<ul style="list-style-type: none"> • Service
Appliance structure <ul style="list-style-type: none"> • tightening of main bolts (screws, fixing systems, etc.) of appliance 	<ul style="list-style-type: none"> • Yearly 	<ul style="list-style-type: none"> • Service
Safety signs <ul style="list-style-type: none"> • check the readability and condition of safety signs 	<ul style="list-style-type: none"> • Yearly 	<ul style="list-style-type: none"> • Service
Electrical control panel <ul style="list-style-type: none"> • check the electrical components installed inside the electrical control panel. Check the wiring between the electrical panel and appliance parts 	<ul style="list-style-type: none"> • Yearly 	<ul style="list-style-type: none"> • Service
Electrical connection cable and plug <ul style="list-style-type: none"> • check connection cable (replace it if necessary) and plug. 	<ul style="list-style-type: none"> • Yearly 	<ul style="list-style-type: none"> • Service
General appliance overhaul <ul style="list-style-type: none"> • check all components, electrical equipment, corrosion, pipes... 	Every 10 years ¹	<ul style="list-style-type: none"> • Service
Preventive maintenance <ul style="list-style-type: none"> • remove any deposits of dirt inside the appliance. 	Every 6 months ²	<ul style="list-style-type: none"> • Service
Control <ul style="list-style-type: none"> • check the conditions of the internal parts. • check and clean the discharge system. 	Every 6 months ²	<ul style="list-style-type: none"> • Service

1. The appliance is designed and built for a duration of about 10 years. After this period of time (from commissioning) the appliance must undergo a general inspection and overhaul.

2. In particular conditions (e. g. intensive use of the appliance, salty environment, etc.) the preventive maintenance should be more frequent.

L.5 Periods of non-use

If the appliance is not going to be used for some time, take the following precautions:

- disconnect the power supply or remove the plug from the power socket, if present;
- carry out a thorough cleaning, following both the daily and weekly cleaning guidelines described in this manual.

- after finishing the deep cleaning, insert the high temperature silicone pad into the appliance to protect the glass.
- remove the frontal bezels and clean / replace the cooling air intake filters
- periodically air the premises.

M TROUBLESHOOTING

M.1 Introduction

Certain faults may occur during normal use of the appliance. In some cases, faults can be eliminated easily and quickly by following the indication below.

The display, if present, always shows a warning message or alarm describing the occurring fault.

With some anomalies, you can hear some acoustic signals.



Warnings icon

2. Switch off the safety circuit breaker ahead of the appliance;
3. Remember to specify:
 - the type of fault
 - the appliance PNC (product number code)
 - the Ser. No. (appliance serial number).



IMPORTANT

The appliance PNC and serial number are essential for identifying the type of appliance and date of manufacture.

If the fault persists, contact the Customer Care Service:

1. Disconnect the appliance from the main power supply;

M.2 Suggestions for quality cooking

Problem	Solution
The sandwich is not enough or too much cooked.	Select another program.
The core temperature of the sandwich is too cold	<ul style="list-style-type: none"> • Increase the time of microwave. • If the time of microwave is more than the total time, increase also the total time.
The core temperature of the sandwich is too hot	Decrease the time of microwave.
The top of the sandwich is burned	Decrease the upper heating plate temperature and (or) decrease the total time. Make sure the RTP is clean and there are no burnt residues that can act as an insulator. Make sure that there is not any dirt between the upper heating plate and the RTP.
The top of the sandwich is not enough cooked	Increase the upper heating plate temperature and (or) increase the total time.
The bottom of the sandwich is burned	Decrease the bottom glass temperature and (or) decrease the total time.
The bottom of the sandwich is not enough cooked	Increase the bottom glass temperature and (or) increase the total time.



IMPORTANT

- The temperature of the upper heating plate is the same for all the programs.
- The temperature of the bottom glass is the same for all the programs.



NOTE!

To modify the parameters refer to paragraph I.5 *Advanced settings*.

M.3 Anomaly table





Anomaly	Anomaly type	Description	Possible causes	Actions
Display shows a BIG YELLOW TRIANGLE	Blocking machine	An error occurred. LOG access is needed to discover the error.	See cause/s relevant to the error LOG report.	<ol style="list-style-type: none"> 1. Press simultaneously buttons "1" and "2" to access the error list; 2. Select the line reporting the latest generated error; 3. Press ENTER (bottom left side hand button) and read the error description; 4. Report to call centre.
Display shows a BIG RED TRIANGLE WITH ONE BLUE AIR WHIFFLE	Warning	Cooling phase because of overtemperature detected at the transformer.	Many sandwiches cooked in quick sequence using microwaves.	<ol style="list-style-type: none"> 1. Wait for the appliance to cool down; 2. Reduce microwaves cooking intensity;
Display shows a BIG RED TRIANGLE WITH TWO BLUE AIR WHIFFLES	Warning	Cooling phase because of overtemperature detected at the magnetron.	<ol style="list-style-type: none"> 1. Long time microwaves use. 2. Room temperature above 35°C/95°F. 3. Magnetron fault. 	<ol style="list-style-type: none"> 1. Wait for the appliance to cool down; 2. Reduce microwaves cooking intensity; 3. In case the warning does not disappear after some minutes, call Service;
Display shows a BIG RED TRIANGLE WITH THREE BLUE AIR WHIFFLES	Warning	Cooling phase because of overtemperature detected on the glass.	<ol style="list-style-type: none"> 1. Cooking with no food on the glass; 2. PT1000 WT temperature sensor not in contact with glass. 	<ol style="list-style-type: none"> 1. Wait for the appliance to cool down; 2. Be sure food is in place before starting a consistent cooking cycle; 3. In case of persistent warning even after setting the cooking in the proper way, call Service.
COMM	Blocking machine	Communication error between ACU and UI boards.	<ul style="list-style-type: none"> • Internal error; • ACU and UI disconnected; • MW internal leakage; • Faulty ACU - Faulty UI. 	If the error persists, call Service.
NTC_HVT	Blocking MW	HV transformer: NTC sensor mal-function (disconnected or in short circuit).	Internal error; NTC HVT not properly cabled; NTC HVT failure.	<ul style="list-style-type: none"> • Turn machine OFF and on; • If the error persists, call Service.

Anomaly	Anomaly type	Description	Possible causes	Actions
T_WT	Blocking machine	Working Top PT1000 sensor mal-function (disconnected or in short circuit).	PT1000 WT not properly cabled; PT1000 WT failure.	<ul style="list-style-type: none"> Check if burned spots are visible in the centre of the glass; Call Service and report the above findings.
T_UP	Blocking machine	Upper Plate PT1000 sensor malfunction (disconnected or in short circuit).	PT1000 UP not properly cabled; PT1000 UP failure.	Check if any visible damages at the flexible tube of the lid; Call Service and report the above findings if any.
ZC_FAIL	Blocking machine	ZC signal absent. Lack of power to heaters and magnetrons.	KLX3 open (components over temperature); J18 on board disconnected; KM malfunction; RL5 on ACU malfunction: faulty ACU.	Check if the machine is exposed to external heat sources; Call Service and report the above findings.
LID_BLK	Blocking machine	Locked lid: the machine cannot open the lid.	<ul style="list-style-type: none"> The lid is blocked; The lid is intentionally either lowered for slightly warming up the sandwich or kept closed at the end of the cooking cycle for increasing the heating of the sandwich; Lid unlocking group disconnected/fault/dirt/gripped.	<ul style="list-style-type: none"> Turn OFF and ON the appliance. Lid should unlock; Verify if the handle can move freely; Check if there are food residuals or other foreign bodies on the pushers and to check if there is anything hindering the movement of the handle; Try to open handle and gently force open the lid. Either clean or lubricate the pushers. If the problem persists, call Service.
MAG1	Only logged: no warning	Possible high voltage electrical circuit malfunctioning.	MAG1 signal absent; HV Capacitor C1 fault; Diode box D1 fault; MAG1 fault; If MAG1 & MAG2 check KS2.	
MAG2	Only logged: no warning	Possible high voltage electrical circuit malfunctioning.	MAG2 signal absent; HV Capacitor C1 fault; Diode box D1 fault; MAG2 fault; If MAG1 & MAG2 check KS2.	
R_WT	Blocking machine	Working top heater malfunction: no current on the heater	Triac TY2 fault on ACU; Heater not properly cabled; Heater fault.	Check if possible to feel heat from the glass (WITHOUT TOUCHING IT!!!)
R_UP	Blocking machine	Upper plate heater malfunction: no current on the heater.	Triac TY1 fault on ACU; Heater not properly cabled; Heater fault.	Check: <ol style="list-style-type: none"> If possible to feel heat from the upper plate (WITHOUT TOUCHING IT!!!); If any visible damages at the flexible tube of the lid; Call Service and report the finding.
WT_TO	Blocking machine	The working top heating element has current, but doesn't heat enough.	Heater damaged.	Try to reset the Error by switching Off/On: if Off/On unsuccessful, call Service.
UP_TO	Blocking machine	Upper plate heater element has current, but doesn't heat enough.	PT1000 temp. sensor not in contact with heating plate; Heater damaged.	Try to reset the Error by switching Off/On: if Off/On unsuccessful, call Service.

Anomaly	Anomaly type	Description	Possible causes	Actions
FAN1_SP	Warning	Fan 1 is not running properly.	Air duct or Fan 1 dirty; Fan 1 fault.	Check: 1. If any visible dirt at the filters louvers; 2. If any fan sound can be heard when operating with the machine Report to service if needed. Report to service if needed.
FAN1_F	Warning	Fan 1 is not running	Fan 1 not properly cabled; Air duct or Fan 1 dirty; Fan 1 fault.	Check: 1. If any visible dirt at the filters louvers; 2. If any fan sound can be heard when operating with the machine
FAN2_SP	Warning	Fan 2 is not running properly.	Air duct or Fan 2 dirty.	Check: 1. If any visible dirt at the filters louvers 2. If any fan sound can be heard when operating with the machine Report to service if needed.
FAN2_F	Warning	Fan 2 is not running.	Fan 2 not properly cabled; Air duct or Fan 2 dirty; Fan 2 fault.	Check: 1. If any visible dirt at the filters louvers 2. If any fan sound can be heard when operating with the machine Report to service if needed.
HVTF_F	Warning	High Voltage; Transformer fan is not running.	HVTF not properly cabled; HVTF fault.	Check: • If any visible dirt at the filters louvers; • If any fan sound can be heard when operating with the machine. Report to service if needed.
KS1_OP	Blocking machine	KS1 open when the lid is closed.	KS1 or S1 disconnected/fault; KS1 auxiliary contact disconnected/fault; Harness; Check MW fuse Fs.	Try to reset the Error by switching Off/On: if Off/On unsuccessful, call Service.
KS2_OP	Blocking machine	SSR (Solid State Relay); KS2 doesn't close.	The lid is not properly closed/the sandwich size exceeds the cooking area; The lid is bumped during closing; Harness; KS2 disconnected/fault; S2 disconnected/fault.	The Error might be caused either by wrong positioning of the sandwich or by too light or heavy handling of the lid while closing it: 1. Reset the Error by switching Off/On 2. Ensure the food is centered in the middle of the plate and does not interfere with the borders 3. Gently close the lid and ensure the handle is correctly engaged If the problem persists call service.
HV_FUS	Blocking MW	HV transformer protection fuse has blown.	Short circuit at primary or secondary coils of HVT.	It is possible to cook with no microwaves: if MW are needed call Service.
LID_OP	Warning	Manual opening of the lid by the operator during a cycle.	Manual opening of the lid before the cooking cycle ends.	Use the STOP button to interrupt a cooking cycle. Remove the warning according to User Manual procedure.

Anomaly	Anomaly type	Description	Possible causes	Actions
MW_FUS	Blocking Machine	Monitor fuse has blown. Replace it.	KS1 auxiliary contact disconnected; S3 monitor switch in short circuit; Fuse Fs blown.	Disconnect power and call Service.
KLX1	Blocking Machine	Magnetron 1 over temperature.	Air duct or FAN 1 dirty/disconnected/fault; Air duct not properly assembled; Magnetron1 fault.	Wait for the appliance to cool down and reset the Error by switching Off/On. If the error re-occurs call Service.
KLX2	Blocking Machine	Magnetron 2 over temperature.	Air duct or FAN 2 dirty/disconnected/fault; Air duct not properly assembled; Magnetron2 fault.	Wait for the unit to cool down and reset the Error by switching Off/On. If the error re-occurs call Service.
ACU_OT	Blocking Machine	ACU board over temperature.	ACU board over temperature; Air duct dirty; Any of Fan1, Fan2 or HVTF fans fault	Wait for the unit to cool down and reset the Error by switching Off/On. If the error re-occurs call Service.
UP_OT	Blocking Machine	PT1000 upper plate over temperature.	Check integrity of PT1000 up/replace it; Triac in short circuit-Replace ACU.	Wait for the unit to cool down and reset the Error by switching Off/On. If the error re-occurs call Service.
WT_OT	Blocking Machine	PT1000 working top over temperature.	PT1000 temp. sensor not in contact with glass; Triac in short circuit. Replace ACU	Wait for the unit to cool down and reset the Error by switching Off/On. If the error re-occurs call Service.
SMPS_F	Warning	SMPS output voltage too low.	MW internal leakage; SMPS faulty.	Remove the warning according to User Manual procedure. Call service if the warning is repetitive.
BRIDGE	Blocking Machine	Only PEP: is the bridge on J7 jump of ACU.	Poor connection at the bridge of J7 on ACU; Fault on bridge of J7 on ACU.	Reset the Error by switching Off/On. If the error re-occurs, call Service.
LINE	Blocking Machine	A 50Hz appliance is connected to a 60Hz power supply or viceversa.	The appliance has detected a wrong power supply line frequency. Not possible to operate. Please refer to the data plate for correct operational frequency (50 or 60 Hz)	Check the data plate of the machine and report to Service.
LID_WARN	Warning	The lid is not closed properly (twisted) or breakdown of the reed contact S1 or S2.	Reed S1: broken; Reed S2: broken; Lid: twisted; Reed's magnet: lost.	Close the lid ensuring that: 1. the food is correctly positioned in the middle of the plate and does not interfere with the borders; 2. the handle is correctly engaged If the problem persists, call Service.
LID_DAMAG	Blocking machine	The lid is not closed properly. After 5 consecutive times the appliance is blocked and a technician is requested. There is a mechanical or electric issue on the lid.	Reed S1: broken; Reed S2: broken; Lid: twisted; Reed's magnet: lost.	Switch the unit OFF/ON. Close the lid ensuring the handle is correctly engaged. If the anomaly shows up again, call Service.

Anomaly	Anomaly type	Description	Possible causes	Actions
The appliance does not switch on.		Pressing ON/OFF button the machine does not react.	External supply energy missing or interrupted; Machine internal breakage.	Carefully check that the machine cable is intact and that the plug is inserted correctly into the power socket (the power socket has to be functioning). If the problem persists call service.
The appliance shuts off unexpectedly.	Blocking machine	While working, the machine switches OFF with no apparent action from the operator side.	Temporary blackout or false contacts or unintentional power interruptions.	Check the ON/OFF button is correctly pressed or that the cable plug is correctly inserted. If the anomaly re-appears, call service.
The lid doesn't keep closed when the machine is in operating mode	Blocking machine	The operator closes the lid but the lid re-opens.	Dirt accumulation interferes with the closure; Lid unlocking group disconnected/fault.	Remove the dirt from the handle hooks and the front teeth; try to close the lid again: in case still not possible to close the lid, call Service.
The lid doesn't open and the display shows the symbol with the BIG YELLOW TRIANGLE	Blocking machine	Refer to the anomaly: LID_BLK		
The lid does not open completely	Warning	It is needed to keep the lid manually opened.	Lid springs need adjustment or mechanical interference does not allow the lid to open completely.	Remove dirt/debris from the lid hinging area and tilt the lid up and down. Call service if the lid opening cannot be restored.
Much force needed to close the lid or the lid opens violently	Warning	Much force needed to close the lid or the lid opens violently.	Lid springs pulling too much.	<ol style="list-style-type: none"> 1. Hang a weight of about 0,8 kg (Flex version) on the handle of the lid to check whether it tilts down or not: if not, call Service (for standard versions use 1.1 kg weight); 2. Free up space at the back of the unit for preventing damages on the flexible conduit of the lid.
The lid cannot be closed	Blocking Machine	It is not possible to complete the lid closure.	Mechanical interference or lid offset.	Remove any debris from the areas where a mechanical interference could prevent the lid to close. Tilt the lid up and down and check whether the motion is straight or not. In case still not possible to close the lid, call Service.
Light button does not work or display shows even purple colour	Blocking Machine	It is not possible to operate with the buttons or not possible to distinguish any symbol on the display.	Flat cable disconnection.	Call Service.
Buttons do not work	Blocking Machine	Pressing the button (s) there is no consequent action.	Button(s) false contact or worn contact.	Try to switch the machine OFF/ ON. If the button(s) still do not work, call Service.

Anomaly	Anomaly type	Description	Possible causes	Actions
The sandwich is cold inside	Blocking MW	The cooking result does not provide heat inside the sandwich.	The Microwave does not work because of the magnetrons or transformer breakage: other cases are covered by alarms or warnings shown by the display.	EASY TEST: Run a MW cooking cycle: hot air should come out from the back of the machine: if no warm air coming from the back of the machine go for the ACCURATE TEST: Test MW functionality with a 30s MW cycle and a glass (suitable for MW) of cold water in the cavity: if at the end of the cycle the water is still cold, call Service.  CAUTION High care when closing the lid with the glass inside.
Sparks noise is coming from the appliance during a cooking phase	Warning	Sparks noise is coming from the appliance during a cooking phase with use of MW.	1. With MW cycle the food load is absent or too light 2. Lack of cleanness provokes antenna effect with MW	1. Reduce MW time or increase the food load accordingly; 2. Thoroughly clean the machine.
Stains can be seen under the cooking surface	Warning	After cleaning the cooking areas it is clearly noticeable the presence of infiltration under the cooking surface.	Deterioration of the cooking surface sealing.	Clean the cooking surface more frequently and do not use sharp tools for removing the debris/dirt from the sealing path. Call Service if stains increases.
The cooking surface is cracked	Warning	Quarz glass shows fractures.	Misuse.	Stop operating: call Service
The upper plate does not get down	Warning	When trying to unlock the upper plate it does not move.	The tube of the upper plate or the upper plate locking latch are gripped in the upper position.	Carefully try to unlock the tube.  WARNING Risk of burning - cool the machine or use gloves against the heat. Lubricate the unlocking mechanism and the tube; if the problem persists call Service.
The sandwich has no grilling textures	Warning	When the cooking cycle is completed there is no grilling texture on the upper side of the sandwich.	The tube of the upper plate or its mechanical block are stuck in the upper position,	Carefully try to unlock the tube.  WARNING Risk of burning - cool the machine or use gloves against the heat. Call Service.
The sandwich is squashed	Warning	When the cooking cycle is completed the sandwich lays squashed on the cooking surface.	The tube of the upper plate or the upper plate locking latch are gripped in the lower position.	Carefully try to unlock the tube.  WARNING Risk of burning - cool the machine or use gloves against the heat. Call Service.
Smell of burnt	Warning	The appliance releases excessive flavour of burnt.	Lack of cleaning or accumulation of grease/dirt/debris.	Thoroughly clean the appliance and increase the cleaning frequency. If the smell persists, call Service.
Choke cover: dirt or damaged	Warning	The choke cover shows traces of dirt or dark areas or holes	1. Lack of cleaning or accumulation of grease/dirt/debris; 2. Microwaves cooking with empty cavity or low mass of food.	1. Thoroughly clean choke cover for removing grease/dirt/debris; 2. Increase frequency of cleaning; 3. In case of damages (cracks/holes. call service for booking the replacement of the choke cover.

Anomaly	Anomaly type	Description	Possible causes	Actions
Lid conduit: too rigid or damaged.	Warning	The flexible tube connecting the upper plate wiring is excessively rigid or shows damages.	Conduit rigidity increases because of the upper plate wires twisted too many times in the same direction while cleaning the upper plate. Damages will occur consequently to the increased rigidity.	<ol style="list-style-type: none"> 1. Set free the upper plate as for cleaning routine; 2. Find the correct twisting direction for restoring the original flexibility of the conduit; 3. In case of conduit damages, call service and report findings.
Dirt Filters	Warning	The air filters show traces of dirt / dust / grease / debris: risk of overheating	High duty cycle and pollution from the room.	<ol style="list-style-type: none"> 1. Remove the dirt using a rag; 2. Remove the grease from the louvers surface using a rag soaked with degreaser; 3. Remove dust using a vacuum cleaner; 4. Call Service and report the above: filters replacement may be needed.

N APPLIANCE DISPOSAL

N.1 Procedure regarding appliance disposal

At the end of the product's life-cycle, make sure it is not dispersed in the environment.

Different regulations are in force in the various countries, therefore comply with the provisions of the laws and competent bodies in the country where appliance disposal takes place.

The appliance's parts must be disposed of in a differentiated way, according to their different characteristics (e.g. metals, oils, greases, plastic, rubber, etc.).

Before disposing of the appliance, make sure to carefully check its physical condition, and in particular any parts of the structure that can give or break during dismantling.

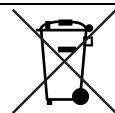

The symbol on the product indicates that this product should not be treated as domestic waste, but must be correctly disposed of in order to prevent any negative consequences for the environment and human health. For further information on the recycling of this product, contact the local dealer or agent, the Customer Care service or the local body responsible for waste disposal.



NOTE!

When dismantling the appliance, any marking, this manual and other documents concerning the appliance must be destroyed.

CE