

# “You are what you eat”

**L. Feuerbach, German philosopher, 1804-1872**

Feuerbach created this maxim in his conclusion to an 1850 work devoted to the theme of nutrition. Naturally he was right. It is what we eat that makes us what we are or what we will be in the near future. So it is important for us to eat healthily.

It is not only how appetising dishes look that is very important, but also the nutritious elements and vitamins they contain.

We have developed the Plug&Cook Combi Oven to enable you to satisfy these criteria with ease.

## Have a good meal!

# Compact Combi Oven

## INSTRUCTIONS FOR USE

### Table of contents

Description of your Plug&Cook Combi Oven.....	18
Safety instructions.....	20
Functions and settings.....	22
Before each use.....	24
Cooking problems and solutions.....	25
Cleaning.....	26
Assembly and disassembly of internal parts.....	26
Technical data.....	27
Installation diagram.....	28



The symbol  on the product indicates that this product should **not** be treated as domestic waste, but must be correctly disposed of in order to prevent possible negative consequences for the environment and the human health. Regarding the recycling of this product, please contact the sales agent or dealer of your product, your after-sales service or the appropriate waste disposal service.

# Description of your Plug&Cook Combi Oven

## General view

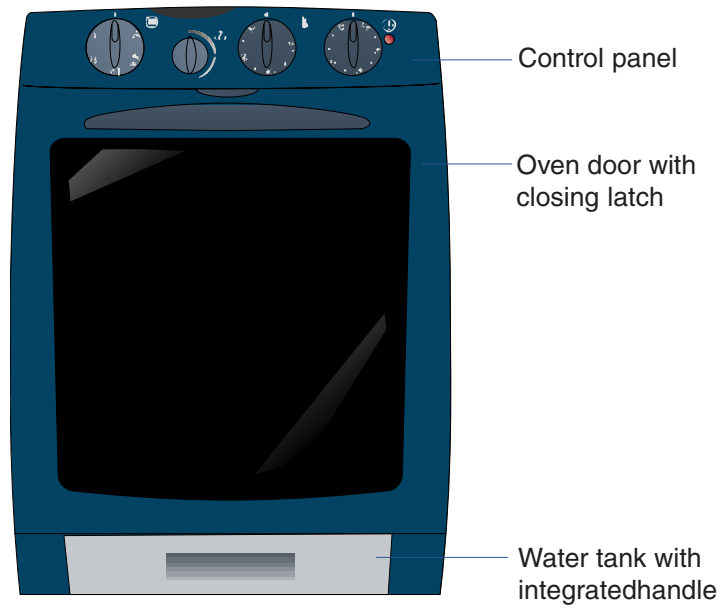

## Control panel

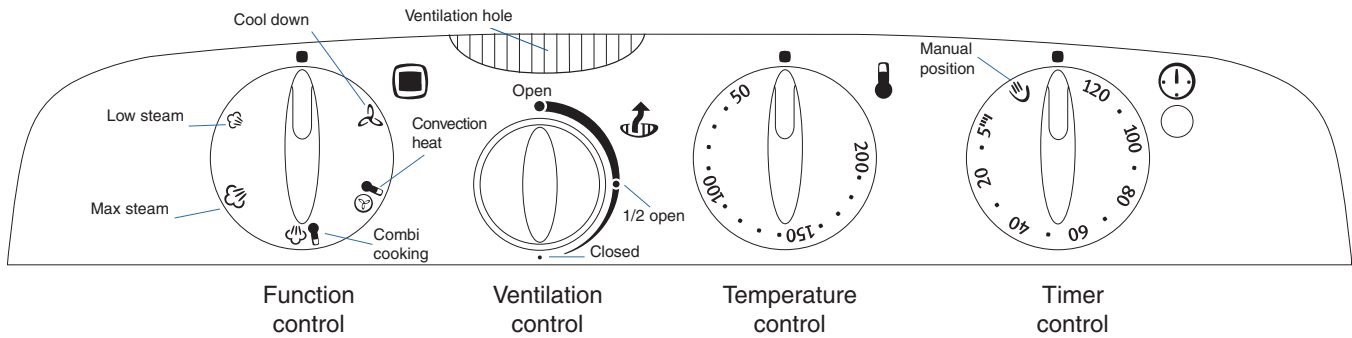

## Oven interior

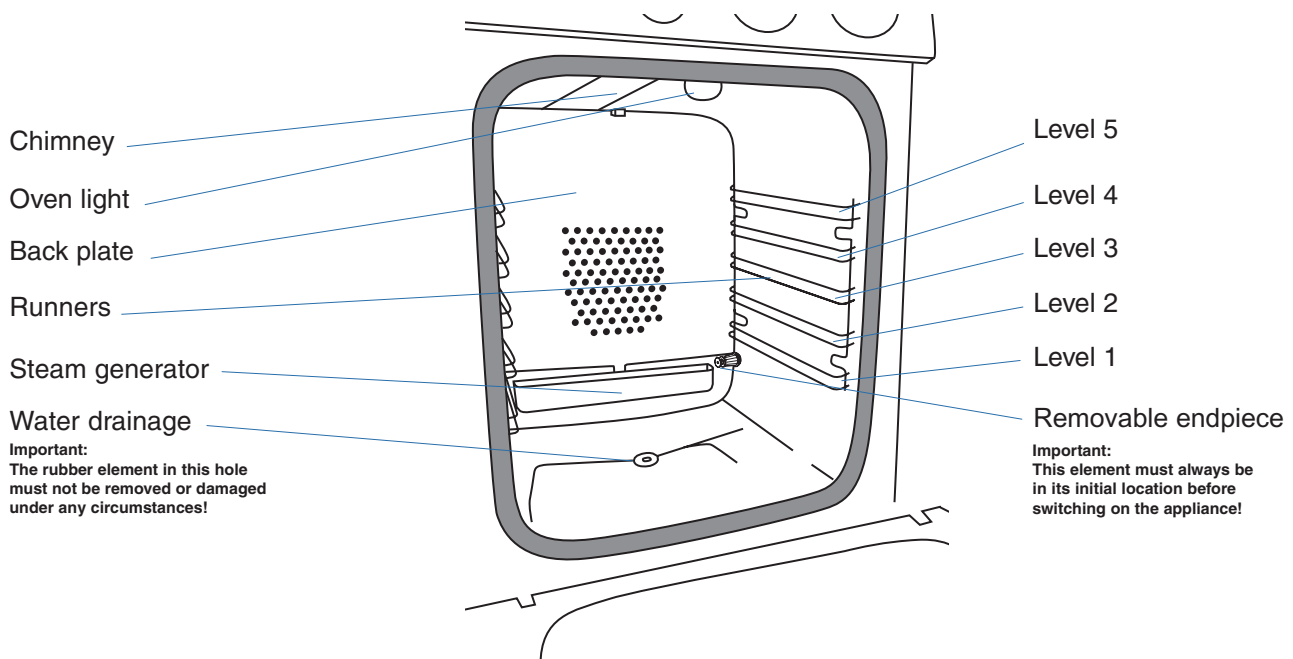

## Water tank

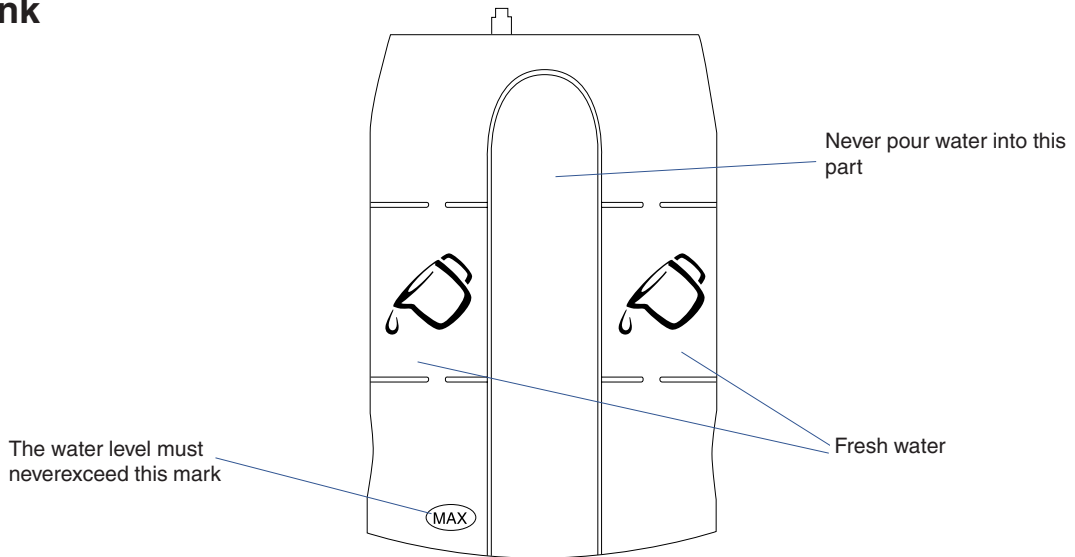

## Lid of tank

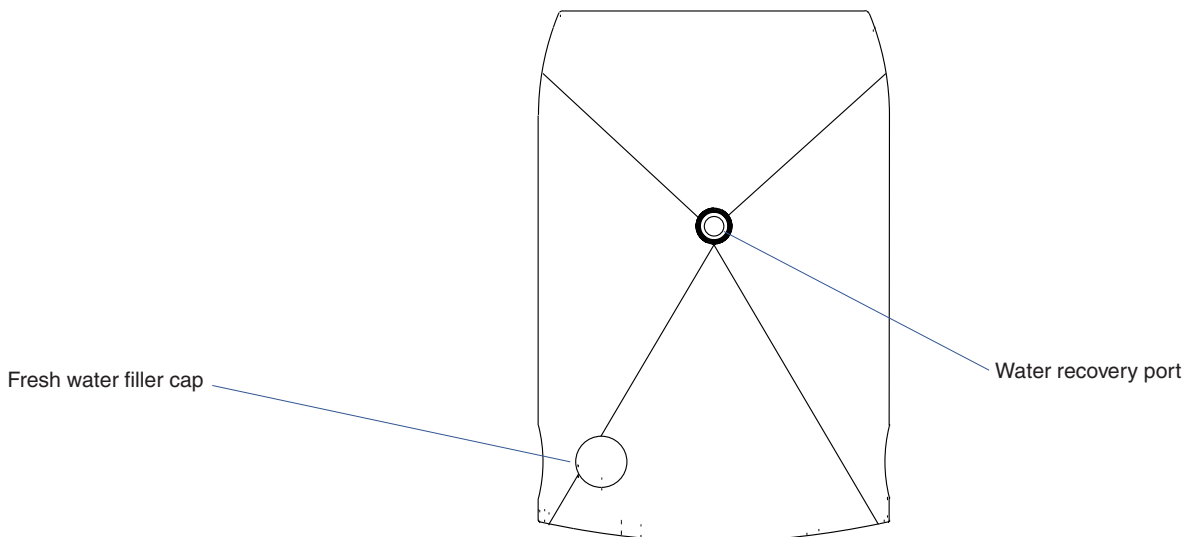

## Positioning the tank fitted with its lid

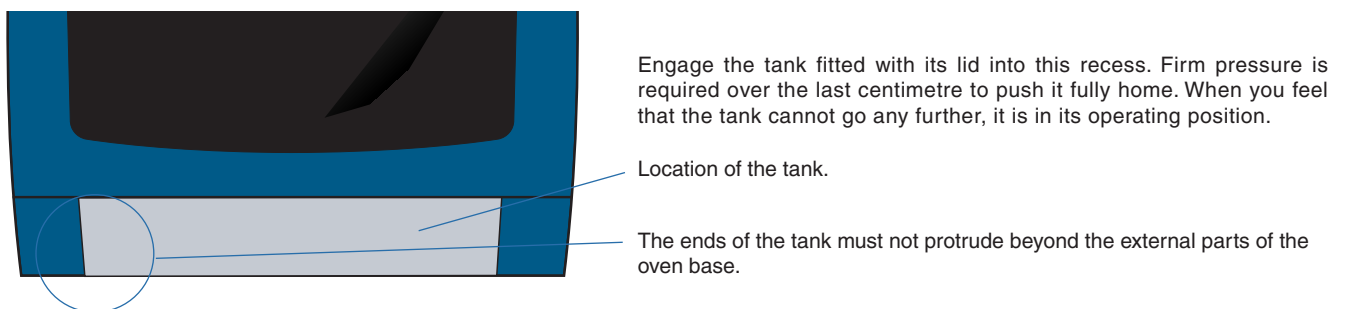

# Safety instructions

Read these instructions carefully and put them in a safe place. They are designed to help you make optimum use of your oven. You must in particular comply with the safety recommendations, which are indicated by an exclamation mark !. Your appliance has been designed to cook foodstuffs only and for no other purpose. It complies with international safety standards. Nevertheless, the existing safety measures do not exclude the risk of an accident.

## Electrical safety

The oven must be connected to an earthed power socket via a fuse with a minimum rating of 13 amps. Check that the outlet cable and plug are in good condition before connecting it.

If your oven displays any defect whatsoever, we recommend that you do not use it.

Disconnect the appliance from the power socket or remove the fuse or cut off the switch/breaker of the circuit to which it is connected.

If you encounter operating problems, refer in priority to the "Before each use" section of this document. If the problem persists, contact our Technical Service. Do not attempt to repair the appliance yourself, as this could lead to more problems.

## Preventing toppling

- ! Place the appliance on a flat surface.
- ! Never rest a weight of more than 3 kg on the opened oven door.

## Children

The front of your oven gets hot during operation and cleaning, therefore keep children away from it.

### When the oven door is open:

- Do not place a heavy weight on it (3 kg maximum).
- Make sure that a child cannot climb or sit on top of it, or pull the handle.

## Utilization

**Take care not to touch the oven surfaces or cooking accessories** with the bare hands when placing dishes in or removing them from the oven, always wear oven gloves. Do not place or stick anything on the external surfaces of the appliance when the oven is operating or has just been used.

Never leave the oven door open when the oven is still hot, as this risks damaging the controls.

If you have another electrical appliance near your oven (e.g. an electric food mixer), make sure there is no risk of

its power cable coming into contact with a very hot surface which could melt it, or of it being jammed in the oven door.

- ! **Take care not to catch your fingers in the door** if you release the handle while it is still open.

- ! **Before opening the doors**, check that the water tank is in its proper position.

## Position of the oven

Make sure that no more than two of the oven surfaces are covered.

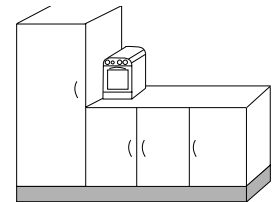

## Cleaning

**Before cleaning your oven by hand, make sure that the internal surfaces are sufficiently cool.**

- ! **We advise against using high-pressure steam appliances to clean the oven (for reasons of electrical safety).**

- ! **You must never clean your oven with a water hose.**

- ! **You must never clean the water tank and its lid in a dishwashing machine.**

## Cooking accessories

**!** Apart from the cooking accessories provided with your oven, we recommend that you only use dishes and cake tins that can withstand high temperatures (follow the manufacturers' instructions).

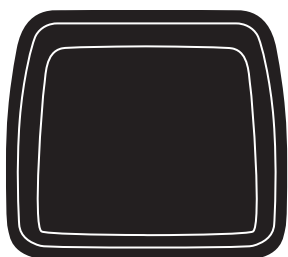

plain container  
H=40 mm / H=65 mm



baking plate

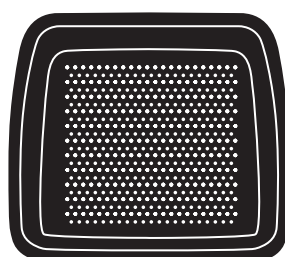

perforated container

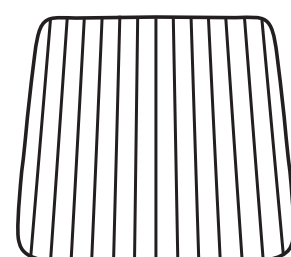

wire grid

## Before using your oven for the first time

### Initial cleaning

Remove the cooking accessories and wash them in soapy water, then rinse and dry them thoroughly.







### Switching the oven on for the first time

**!** Remove the plastic film protecting the outer stainless steel surface of the oven.

Heat up the oven with nothing in it before using it for the first time. When doing this, check that the room is sufficiently aired by switching on the fan and opening the window.

Do not worry if the water in the steam generator boils strongly during this heating up process.

### Instructions

- 1 Remove all the cooking accessories from the oven.
- 2 Plug in the oven.
- 3 Fill the “fresh water”  part of the tank with 100 cl of tap water.
- 4 Select the “Combi cooking” function  with the first control knob.
- 5 Set the ventilation  to the fully open position.
- 6 Set the temperature control  to 200°C.
- 7 Set the “Timer”  scontrol to manual .
- 8 When the water tank is empty, fill it with 100 cl of water  and reinstall it without changing the settings.
- 9 Your oven is ready for use once the water tank has been emptied again.

# Functions and settings

## Cooking functions

### Max steam



The steam temperature is above 98°C. This rapid method of cooking featuring all the necessary precautions is particularly suited to the majority of foodstuffs cooked in water. The foodstuffs conserve their vitamins as well as their shape and colour. This method is used above all for vegetables and potatoes. The food can be cooked just as well in the plain containers as in the perforated containers.

### Low steam



The steam temperature is about 85°C. Low steam is a combination between high humidity and precise temperature control. This method protects the dishes while conserving their mineral salts and vitamins, as well as their taste, form and colour. Low steam means slow even cooking. Foodstuff weight loss is kept to a minimum. This method of cooking is ideal for fish and pâtés, warming up meat dishes, and also for heating up “vacuumpacked” products.

### Combi cooking



The steam temperature is about 85°C. Low steam is a combination between high humidity and precise temperature control. This method protects the dishes while conserving their mineral salts and vitamins, as well as their taste, form and colour. Low steam means slow even cooking. Foodstuff weight loss is kept to a minimum. This method of cooking is ideal for fish and pâtés, warming up meat dishes, and also for heating up “vacuumpacked” products.

### Convection heat



This method is suitable for roasting. You can also use it to cook fillets of fish and meat, cutlets, pâtés, potato dishes, gratins, cakes and biscuits.

### Cooling function



This function is meant to be used when you want to switch from one cooking process (Convection heat or Combi) to another one at a much lower temperature (Low and Max steam). When you select this function then only the fan will be on and not the heating elements. This will enable the oven cavity temperature to cool down rapidly to a suitable temperature for heat sensitive foods (vegetable or fish). Make sure the ventilation control is set to the fully open position. If you want to speed up this cooling process even more, leave the door open while this function is selected.

## It is as simple as that

The Plug & Cook Combi Oven is very simple to use. You only have 4 settings to think about:

- **The cooking function**
- **The ventilation**
- **The temperature**
- **The time**



### Setting the main functions

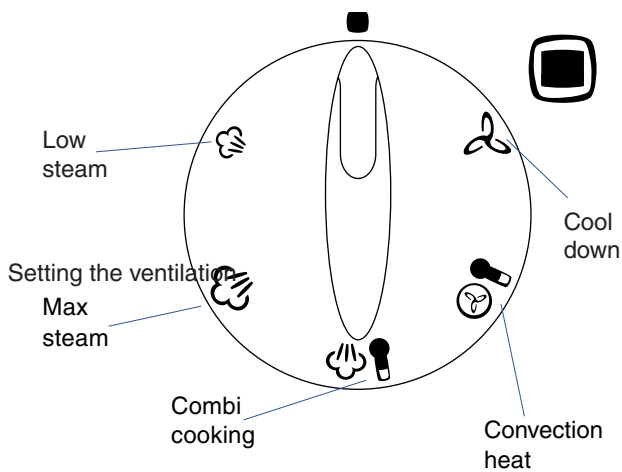

### Setting the temperature

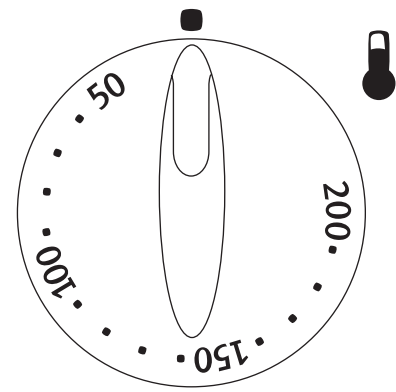

The temperature is set using the thermostat knob. Turn it clockwise to the desired temperature.

### Setting the ventilation

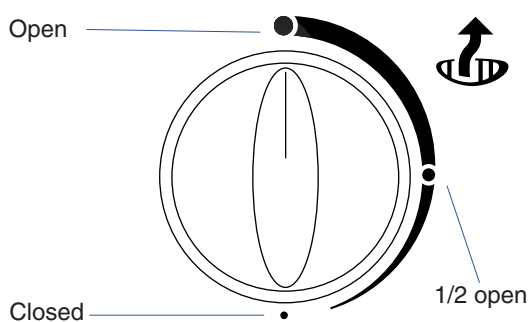

**Important:**

- Never select this position in "Combi cooking" or "Convection heat" mode!
- Even if this position is selected, it is normal to see a slight discharge of steam at the ventilation hole on the panel.

### Setting the timer

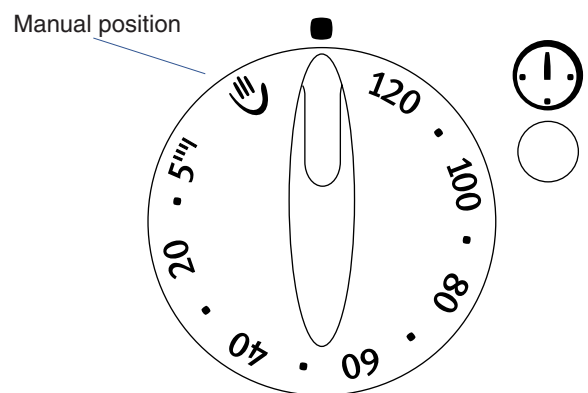

Simply turn the knob clockwise to the desired cooking duration.



# Before each use

## Choice of accessory

The choice of cooking accessory is of great importance for successful cooking. The wrong cooking accessory can cause irregular heat distribution within the preparation itself or within the oven. Save your ovenproof glass dishes for cooking gratins and soufflés.

Certain food preparations increase in volume during cooking, in such cases choose containers that leaves the top third free.

The thickness, heat conductivity and colour of the receptacles affect cooking results.

## Even distribution of the ingredients in the cooking accessory

Distribute the ingredients evenly in the cooking container. To ensure even cooking, it is important that the hot air and steam should be able to circulate freely among the ingredients.

## Steam

You can cook in either the non-perforated or the perforated cooking accessories. With fish dishes, you should use a non-perforated accessory in order to be able to use the fish stock. When cooking vegetables and potatoes it is preferable to use the perforated accessories.

We advise you to season your dishes before cooking and to check the seasoning after cooking.

## Small cooking dishes

When using small dishes such as gratin dishes, better results are obtained if they are laid on a wire grid.

## General recommendations

Always place food that spatters in the bottom of the oven.

Leave as little lard in the pan as possible to reduce spattering and obtain a dish with less fat in it.

To save time and energy, take advantage of the hot oven to cook other dishes.

If you find that your dish is too dark in colour, reduce the temperature.

If you find that your dish is too light in colour, not well enough cooked, or is cooking too slowly, increase the temperature.

## Each time before use

The technology implemented in the Plug&Cook Combi Oven gives you a vast range of possibilities. We are making our latest innovation available to you. Your culinary success depends essentially on the quality of the ingredients used! You need to experiment to get the best results using the possibilities and qualities offered by this appliance.

Below are a few instructions to be followed before switching on the oven.

## Verification

Check that all the parts are operational. Always fill the water tank with water before cooking, except when in “Convection heat” mode.

In “Combi” and “Convection heat” mode make sure that the ventilation is open. Check that the door-locking latch is properly engaged before starting cooking.

## Preheating

It is sometimes necessary to preheat the oven before cooking certain dishes (see the Cooking guide and Recipes).

The oven heats up and as soon as it reaches the selected temperature the preheating indicator light goes out and you can put your dish into the oven.

# Cooking problems and solutions

We strongly recommend that you check the following points before calling our technician.  
The problem might be a very simple one that you can solve yourself.

Problem	Cause	Solutions
The oven does not function		Check that: <ul style="list-style-type: none"> <li>– the fuses are intact</li> <li>– the oven is correctly connected to the power supply</li> <li>– there is not a power failure</li> <li>– the oven door is properly closed</li> </ul>
The cooking results are unsatisfactory		Check that: <ul style="list-style-type: none"> <li>– the preheating temperature and time are correct</li> <li>– the correct cooking function has been chosen</li> <li>– the temperature setting is correct</li> <li>– the chosen cooking time is correct</li> <li>– the grill or other cooking accessory is correctly positioned in the oven</li> <li>– the appropriate cooking container is being used</li> <li>– the ventilation knob is correctly set</li> </ul>
Potatoes or green vegetables take an abnormally long time to cook	Ventilation open Type of potato	Close the ventilation No solution to offer Certain types of potatoes take longer to cook than others
Fish dishes break up	Temperature too high	Use the Low steam function
Irregular roasting results	Cooking accessory of inappropriate depth Wrong ventilation setting Oven not preheated	See “Recommendations and tips” See “Recipes” or “Cooking guide” Preheat oven before putting in the dishes See “Recipes” or “Cooking guide”
Roasting surface dry and hard, too browned	Temperature too high	Reduce the temperature. See “Recipes” or “Cooking guide”
Irregular cooking results	Ill-adapted cooking accessories Cooking accessory filled too full	See “Recommendations and tips” See “Recommendations and tips”
Pastries brown too quickly	Temperature too high	Reduce the temperature. See “Recipes” or “Cooking guide”
Correct colouring in the corners but too light in the middle	Incorrect ventilation setting	See “Recommendations and tips”
The oven does not produce steam	Ventilation open Lack of water	Close the ventilation Put water in the tank
In combi cooking mode, meats and pastries become too brown	Ventilation closed Temperature too high	Open the ventilation Reduce the temperature
Preparations that should rise “do not rise” or rise then fall	Ventilation closed Dish at too low a level	Open the ventilation Move the dish up a level
White meat dishes are too dry	Wrong cooking function	Choose another function. See “Recipes” or “Cooking guide”

# Cleaning

## General cleaning recommendations

The outside of the oven, the water tank and its lid must only be cleaned with a sponge and soapy water. Rinse thoroughly and dry.

We recommend that you do not use scouring cream. You can clean the oven interior with a multipurpose cleaning product.

The cooking accessories can be cleaned with a sponge and soapy water, taking care to thoroughly rinse and dry them, or they can be washed in a dish-washing machine.



## Cleaning the steam generator

- 1 Pour a cleaning product (e.g. vinegar) directly into the steam generator.
- 2 Leave it to act for 45 minutes.
- 3 Wipe the cavity and generator with a cloth.

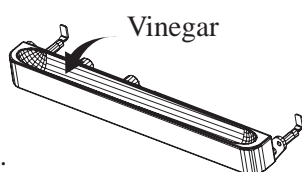

## Assembly and disassembly of internal parts

### The chimney

- 1 The chimney is situated in the top of the cavity and must be cleaned regularly. To remove it, simply turn the screws anticlockwise using a coin.
- 2 You can wash the chimney in a dishwasher or with a sponge soaked in soapy water. Put it back in place after cleaning it.

### Runners

- 1 Unscrew the screws in the front upper corner of each runner and remove them.
- 2 Reinstall the runners in the reverse order of disassembly.

### Back plate

- 1 Remove the screw in the front upper part of the back plate.
- 2 Lift and slide the back plate to remove it.
- 3 Reinstall the back plate in the reverse order of removal.

### Replacing the oven light

- !** Before replacing the oven light, disconnect the oven from the electrical power supply and check that the interior is cool.

The 15W bulb is a special bulb that withstands high temperatures. The bulb is located at the top of the oven cavity and is accessible from the interior.

### Access to the bulb

- 1 Unscrew the glass cover of the light by turning it anticlockwise.
- 2 Unscrew the bulb.
- 3 Screw in the new bulb.
- 4 Screw the glass cover firmly back in place.

# Technical data

Cooking functions	Convection heat, Steam cooking, Low temperature steam, Combined steam/Convection heat
Electrical power supply	230 V 50 Hz
Power supply cord	Power supply lead must only be replaced by an authorised electrical installation engineer.
<b>Power consumption</b>	
Steam	700 W
Combined	2050 W
Convection heat	1350 W
Maximum consumption	2150 W
Oven lighting	15 W
<b>Dimensions</b>	
Height	466 mm
Width	352 mm
Depth	548 mm (900 mm with door open)
Net weight	22 kg
Effective volume	30 litres
<b>Water tank</b>	
Capacity of “fresh water” section	1 litre
Capacity of “recovered water” section	0,55 litre

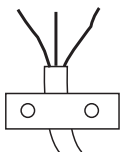

# Installation diagram

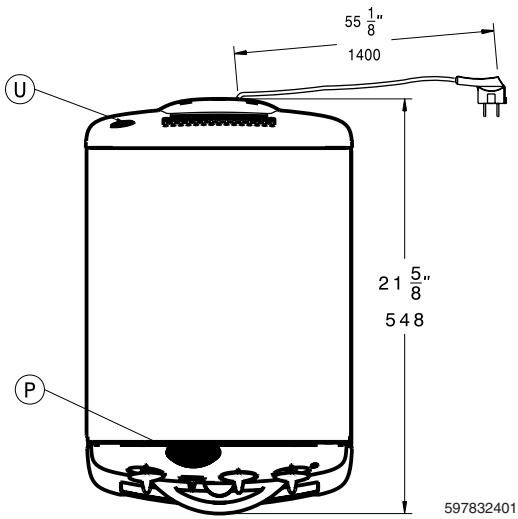
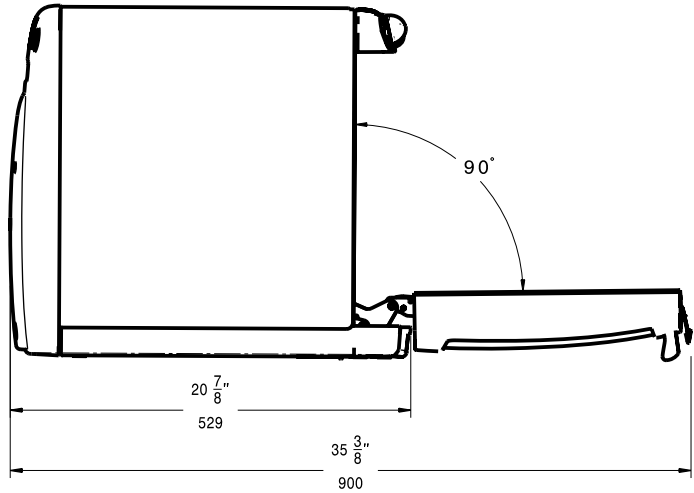
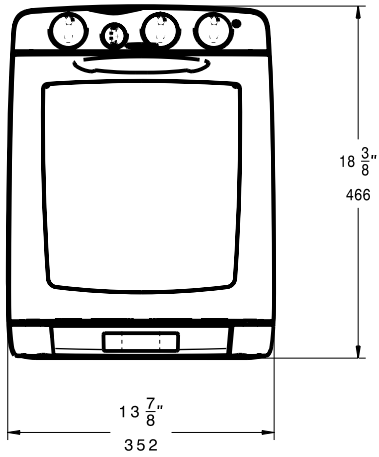

U - Air intake  
P - Fumes outlet

**NO TEXT ON THIS PAGE**