

FOREWORD	7	6. Installation and assembly	25
READ AND SAVE THESE INSTRUCTIONS.....	8	6.1 Introduction.....	25
1. Warning and safety information	8	6.2 Installing your wine cellar	25
1.1 General information	8	6.3 Installation instructions for built-in wine cellar	25
1.2 Personal protection equipment.....	10	6.4 Installation drawings for built-in wine cellars.....	26
1.3 General safety.....	10	6.3 Before loading & plugging in the wine cellar.....	26
1.4 General safety rules.....	11	6.7 Disposal of packing.....	27
1.5 Transport, handling and storage	12	7. Appliance start-up.....	27
1.6 Installation and assembly.....	13	7.1 Turning on your wine cellar.....	27
1.7 Positioning.....	15	8. Features	28
1.8 General safety rules.....	15	8.1 Loading your wine cellar.....	28
1.9 Product loading and unloading.....	19	8.2 Types of regulation.....	28
1.10 Machine cleaning and maintenance	20	8.3 Temperature settings.....	28
1.11 Service.....	20	8.4 Wine serving temperature chart.....	28
1.12 Dismantling.....	21	8.5 Important information about temperature.....	29
2. General information.....	22	8.6 Defrosting/condensation/hygrometry/ventilation.....	29
2.1 Introduction.....	22	8.7 Adjustable wooden shelves	29
2.2 Additional indications	22	9. Care	29
2.3 Intended use and restrictions.....	22	10. Power failure	30
2.4 Testing and inspection	22	10.1 Power failures	30
2.5 Mechanical safety characteristics, hazards.....	22	11. Machine cleaning and maintenance	30
2.6 Copyright	22	11.1 Ordinary maintenance	30
2.7 Keeping the manual.....	22	11.1.1 Precautions for maintenance	30
2.8 Recipients of the manual	22	11.1.2 Cleaning the cabinet and accessories.....	30
2.9 Definitions	22	11.2 Extraordinary maintenance.....	31
2.10 Machine and manufacturer's identification data.....	23	11.2.1 Maintenance intervals.....	31
2.11 Responsibility.....	23	12. Machine disposal.....	31
3. Normal machine use.....	23	12.1 Waste storage	31
3.1 Characteristics of personnel trained for normal machine use.....	23	12.2 Procedure regarding appliance dismantling macro operations.....	31
3.2 Characteristics of personnel enabled to operate on the machine	23	13. Enclosed documents	32
3.3 Operator qualified for normal machine use.....	23	14. Troubleshooting guide	33
4. Transport, handling and storage.....	24		
4.1 Introduction.....	24		
4.2 Handling	24		
4.3 Procedures for handling operations.....	24		
4.4 Shifting.....	24		
4.5 Placing the load	24		
4.6 Unpacking	24		
4.7 Storage.....	24		
5. Technical data	25		

FOREWORD



The installation, use and maintenance Manual (hereinafter Manual) provides the operator with information necessary for correct and safe installation and use of the machine (hereinafter "machine" or "appliance").

The following must not be considered a long and exacting list of warnings, but rather a set of instructions suitable for improving machine performance in every respect and, above all, preventing injury to persons and animals and damage to property due to improper operating procedures.

All persons involved in machine transport, installation, commissioning, use and maintenance, repair and disassembly must consult, carefully read and fully understand this manual before carrying out the various operations, in order to avoid wrong and improper actions that could compromise the machine's integrity or endanger people. Make sure to periodically inform the appliance user regarding the safety regulations. It is also important to instruct and update personnel authorised to operate on the machine, regarding its use and maintenance.

The manual must be available to operators and carefully kept in the place where the machine is used, so that it is always at hand for consultation in case of doubts or whenever required.

If, after reading this manual, there are still doubts regarding machine use, do not hesitate to contact the Manufacturer or the authorised after-sales service centre, to receive prompt and precise assistance for better operation and maximum efficiency of the machine.

During all stages of machine use, always respect the current regulations on safety, work hygiene and environmental protection. It is the user's responsibility to make sure the machine is started and operated only in optimum conditions of safety for persons, animals and property.

IMPORTANT



- ▶ The Manufacturer declines any liability for operations carried out on the appliance without respecting the instructions given in this manual.
- ▶ The manufacturer reserves the right to modify the appliances presented in this publication without notice.
- ▶ NO part of this manual may be reproduced.
- ▶ This manual is available in digital format by contacting the dealer or reference customer care.
- ▶ The manual must always be kept in an easily accessed place near the machine. Machine operators and maintenance personnel must be able to easily find and consult it at any time.

The Manufacturer offers no guarantee for our wine cellar if it is being used for any purpose other than that for which it was specifically designed. The Manufacturer cannot be held responsible for any error in this manual. The Manufacturer is not responsible or liable for any spoilage or damage to wines or any other contents incidental or consequential to possible defects of the wine cellar. Warranty applies to the wine cellar only and not to the content of the wine cellar.

This appliance is not intended for use by persons (including children) with reduced physical, sensory or mental capabilities, or lack of experience and knowledge, unless they have been given supervision or instruction concerning use of the appliance by a person responsible for their safety.

Children should be supervised to ensure that they do not play with the appliance.

READ AND SAVE THESE INSTRUCTIONS

As previously said, these instructions include information which is intended to assure the operator of correct installation, operation and service. Before attempting installation, adjustment or maintenance, be certain of the following:

- ▶ that you have read and fully understand the instructions;
- ▶ that you have all the tools required and are trained to use them;
- ▶ that you have met all installation and usage restrictions and are familiar with the functions and operations of the unit;
- ▶ that you follow all instructions exactly as given.

All the fittings, measurements, recommendations and procedures are significant. Substitutions and approximations must be avoided. Improper handling, maintenance, installation and adjustment, or service attempted by anyone other than a qualified technician, may void the future warranty claims and cause damage to the unit and/or result in injury to the operator and/or bystanders.

1. Warning and safety information

Read all instructions before using this appliance

1.1 General information

To ensure safe use of the machine and a proper understanding of the manual it is necessary to be familiar with the terms and typographical conventions used in the documentation.

The following symbols are used in the manual to indicate and identify the various types of hazards:



WARNING

Danger for the health and safety of operators.



WARNING

Danger of electrocution - dangerous voltage.



CAUTION

Risk of damage to the machine or the product.



IMPORTANT

Important instructions or information on the product.



Read the instructions before using the appliance.



NOTE





Clarifications and explanations.

- ▶ Only specialised personnel are authorised to operate on the machine.
 - Do not let children play with the appliance.
 - Keep all packaging and detergents away from children.
 - Cleaning and user maintenance shall not be made by children without supervision.

- ▶ Do not store explosive substances, such as pressurized containers with flammable propellant, in this appliance.
- ▶ Do not remove, tamper with or make illegible the safety, danger and instruction signs and labels on the machine.
- ▶ Refer to the data given on the machine's data plate marking for relations with the Manufacturer (e.g. when ordering spare parts, etc.).
- ▶ When scrapping the machine, the marking must be destroyed.
- ▶ Before carrying out any operation on the machine, always consult the manual which gives the correct procedures and contains important information on safety.
- ▶ Save these instructions carefully for further consultation by the various operators.

1.2 Personal protection equipment

Summary table of the Personal protection Equipment (PPE) to be used during the various stages of the machine's service life.

Stage	Protective garments 	Safety footwear 	Gloves 	Glasses 	Safety helmet 
Transport	—	●	○	—	○
Handling	—	●	○	—	—
Unpacking	—	●	○	—	—
Installation	—	●	○	—	—
Normal use	○	○	●*	—	—
Adjustments	○	●	—	—	—
Routine cleaning	○	●	●*	○	—
Extraordinary cleaning	○	●	●	○	—
Maintenance	○	●	○	—	—
Dismantling	○	●	○	○	—
Scrapping	○	●	○	○	—
Key:					
●	PPE REQUIRED				
○	PPE AVAILABLE OR TO BE USED IF NECESSARY				
—	PPE NOT REQUIRED				

(*) During **Normal use**, gloves protect hands from the cold product when being removed from the appliance.

Note: the gloves to be worn during Cleaning are the type suitable for contact with the cooling fins (metal plates).

Failure to use the personal protection equipment by operators, specialised technicians or users can involve exposure to chemical risk and possible damage to health.

1.3 General safety

- The machines are provided with electric and/or mechanical safety devices for protecting workers and the machine itself. Therefore the user must not remove or tamper with such devices. The Manufacturer declines any liability for damage due to tampering or their non-use.
- Never operate the machine, removing, modifying or tampering with the guards, protection or safety devices.
- Several illustrations in the manual show the machine, or part of it, without guards or with guards removed. This is purely for explanatory purposes. Do not use the machine without the guards or with the protection devices deactivated.

- Do not remove, tamper with or make illegible the safety, danger and instruction signs and labels on the machine.

1.4 General safety rules

R600A WARNINGS

This appliance contains R600A (iso-butane) flammable refrigerant which is environmentally friendly, but flammable. It does not damage the ozone layer, nor does it increase the greenhouse effect. The quantity of gas used is given on the data plate.

For your safety please observe the following recommendations:

- During transportation and installation, ensure that the tubing of the refrigerant circuit is not damaged.
- Avoid using or manipulating sharp objects near by the appliances.
- Leaking refrigerant can ignite and may damage the eyes.
- In the event any damage does occur, avoid exposure to open fires and any device which creates a spark. Disconnect the appliance from the mains power.
- Thoroughly ventilate the room in which the appliance is located for several minutes.
- Notify Customer Service for necessary action and advice.
- The room for installing the appliance must be at least 1 cubic metre per 8 grams of refrigerant. The refrigerant quantity contained in this appliance is noted on the Rating Plate of the appliance.

It is hazardous for anyone other than an Authorised Service Person to carry out servicing or repairs to this appliance.

WARNING



R600A gas is potentially flammable and explosive! Take every possible precaution to prevent any risk linked to the nature of this gas during any routine and/or extraordinary operation carried out on the appliance. Only specialised personnel are authorised to operate on the machine.

CAUTION



- Keep ventilation openings in the appliance enclosure or in the built-in structure clear of obstruction.
- Do not use mechanical devices or other means to accelerate the defrosting process, other than those recommended by the Manufacturer.
- Do not damage the refrigerant circuit.
- Do not use electrical appliances inside the compartments.
- In Queensland Australia, the authorized person must hold a gas Wok Authorisation for hydrocarbon refrigerants, before carrying out servicing or repairs which involve the removal of covers.

Allow 24 hours before switching on the wine cellar. During this time we recommend that you leave the door open to clear any residual odors.

1.5 Transport, handling and storage

- Do not stand under suspended loads during loading/unloading operations. Unauthorised personnel must not enter the work area.
- The weight of the appliance alone is not sufficient to keep it steady.
- For machine lifting and anchoring, do not use movable or weak parts such as: casings, electrical raceways, pneumatic parts, etc.
- Do not push or pull the machine to move it, as it may tip over. Use proper tool to lift the machine.
- Machine transport, handling and storage personnel must be adequately instructed and trained regarding the use of lifting systems and personal protection equipment suitable for the type of operation carried out.

1.6 Installation and assembly

Introduction

- ▶ Machine installation and assembly operations must only be carried out by specialised personnel provided with all the appropriate personal protection equipment, tools, utensils and ancillary means, with adequate enclosure of the assembly area to keep out unauthorised persons.
- ▶ The operations described must be carried out in compliance with the current safety regulations.
- ▶ Disconnect the appliance from the power supply before carrying out any installation and assembly procedure.

Electrical connection

Grounding instructions:

The wine cellar must be grounded in case of an electrical short circuit. Grounding reduces the risk of electrical shock. The wine cellar is equipped with a power cord having a grounding wire and plug. The wine cellar plug must be plugged into a properly affixed and grounded electrical outlet.

Note: *in locations where there is frequent lightning, it is advisable to use surge protectors.*

Improper use of the grounding plug can result in the risk of electric shock. Consult a qualified electrician or service person if the grounding instructions are not completely understood.

If the supply cord is damaged, it must be replaced by a qualified person in order to avoid electrical hazard.

- ▶ Work on the electrical systems must only be carried out by a qualified electrician.
- ▶ Connection to the power supply must be carried out in compliance with the regulations and provisions in force in the country of use.
- ▶ The information regarding the appliance power supply voltage is given on the dataplate.

- These guidelines must be followed to ensure that safety mechanisms in the design of this appliance will operate properly.
- Avoid fire hazard or electric shock. Do not use an extension cord or an adapter plug. Do not remove any prong from the power cord.
- If the voltage varies by 10 percent or more, appliance performance may be affected. Operating the appliance with insufficient power can damage the compressor. Such damage is not covered under the warranty. If you suspect your voltage is high or low, consult your power company for testing.
- To prevent the appliance from being turned off accidentally, do not plug the unit into an outlet controlled by a wall switch or pull cord.
- DO NOT pinch, knot, or bend the power cord in any manner.
- **NEVER** unplug the appliance by pulling on the power cord. Always grip the plug firmly and pull straight out from the receptacle.
- To avoid electrical shock, unplug the appliance before cleaning.



NOTE

Turning the control to "OFF" turns off the compressor but does not disconnect power to other electrical components.

To connect, just insert the power cable plug in the corresponding mains socket, **first making sure:**

- the socket has an efficient earth connection and the mains voltage and frequency match that given on the dataplate. In case of any doubts regarding the efficiency of the earth connection have the system checked by qualified personnel;
- the system power supply is arranged and able to take the actual current absorption and that it is correctly executed according to the regulations in force in the country of use;
- the plug must be accessible after positioning the appliance in the place of installation;
- the plug must be in a position always visible to the operator performing the intervention during maintenance operations.
- A differential thermal-magnetic switch suitable for the absorption specified on the dataplate, with contact gap enabling complete disconnection in category III overvoltage conditions and complying with the regulations in force, is installed between the power cable and the electric line. For the

correct size of the switch, refer to the absorbed current specified on the appliance datplate.

- The system power supply is arranged and able to take the actual current absorbed and that it is correctly execute according to the regulations in force in the country of use;
- after making the connection, with the appliance running check that the power supply does not fluctuate by $\pm 10\%$ the rated voltage.
- The manufacturer declines any liability for damage or injury resulting from breach of the above rules or non-compliance with the electrical safety regulations in force in the country where the machine is used.

1.7 Positioning

- Install the appliance, taking all the safety precautions required for this type of this type of operation, also respecting the relevant fire-prevention measures.



WARNING

Keep the ventilation openings in the appliance casing free of any obstructions.





1.8 General safety rules

Protection devices installed on the machine

- The guards on the machine are:
 - fixed guards (e.g. casings, covers, side panels, etc.), fixed to the machine and/or frame with screws or quick-release connectors that can only be removed or opened with tools;
 - interlocked movable guards (door) for access inside the machine;
 - machine electrical equipment access doors, made from hinged panels

openable with tools. The door must not be opened when the machine is connected to the power supply.

Safety signs to be placed on the machine or near its area:

Prohibition	Meaning
	do not remove the safety devices
	do not use water to extinguish fires (placed on electrical parts)
Danger	Meaning
	danger of burns
	danger of electrocution (shown on electrical parts with indication of voltage)

End of use

- When the appliance is no longer to be used, make it unusable by removing the mains power supply wiring.

Instructions for use and maintenance

- Risks mainly of a mechanical, thermal and electrical nature exist in the machine. Where possible the risks have been neutralised:
 - directly, by means of adequate design solutions.
 - indirectly by using guards, protection and safety devices.
- Any anomalous situations are signalled on the control panel display.
- During maintenance several risks remain, as these could not be eliminated, and must be neutralised by adopting specific measures and precautions.
- Do not carry out any checking, cleaning, repair or maintenance operations on moving parts. Workers must be informed of this prohibition by means of clearly visible signs.
- To guarantee machine efficiency and correct operation, periodical maintenance must be carried out according to the instructions given in this manual.

- ▶ Make sure to periodically check correct operation of all the safety devices and the insulation of electrical cables, which must be replaced if damaged.
- ▶ Extraordinary machine maintenance operations must only be carried out by specialised personnel provided with all the appropriate personal protection equipment, tools, utensils and ancillary means.
- ▶ Never operate the machine, removing, modifying or tampering with the guards, protection or safety devices.

Reasonably foreseeable improper use

Improper use is any use different from that specified in this manual. During machine operation, other types of work or activities deemed improper and that in general can involve risks for the safety of operators and damage to the appliance are not allowed. Reasonably foreseeable improper use includes:

- ▶ lack of machine maintenance, cleaning and periodical checks;
- ▶ structural changes or modifications to the operating logic;
- ▶ tampering with the guards or safety devices;
- ▶ failure to use personal protection equipment by operators, specialised personnel and maintenance personnel;
- ▶ failure to use suitable accessories (e.g. use of unsuitable equipment or ladders);
- ▶ keeping combustible or flammable materials, or in any case materials not compatible with or pertinent to the work, near the machine;
- ▶ wrong machine installation;
- ▶ placing in the machine any objects or things not compatible with its use, or that can damage the machine, cause injury or pollute the environment;
- ▶ climbing on the machine;
- ▶ non-compliance with the requirements for correct machine use;
- ▶ other actions that give rise to risks not eliminable by the Manufacturer.
- ▶ Failure to insure complete closure of the door, through forgetfulness or carelessness.
- ▶ Place the product in the compartments so as to block proper air circulation or hinder the perfect closing of the door.
- ▶ Exceed product weight allowed for each shelf:

The previously described actions are prohibited!

Residual risks

- The machine has several risks that were not completely eliminated from a design standpoint or with the installation of adequate protection devices. Nevertheless, through this manual the Manufacturer has taken steps to inform operators of such risks, carefully indicating the personal protection equipment to be used by them. Sufficient spaces are provided for during the machine installation stages in order to limit these risks.

To preserve these conditions, the areas around the machine must always be:

- kept free of obstacles (e.g. ladders, tools, containers, boxes, etc.);
- clean and dry;
- well lit.

For the Customer's complete information, the residual risks remaining on the machine are indicated below: such actions are deemed improper and therefore strictly forbidden.

Residual risk	Description of hazardous situation
Slipping or falling	The operator can slip due to water or dirt on the floor.
Burns/abrasions (e.g. heating elements, cold pan, cooling circuit plates and pipes)	The operator deliberately or unintentionally touches some components inside the machine without using protective gloves.
Electrocution	Contact with live parts during maintenance operations carried out with the electrical panel powered.
Tipping of loads	When handling the machine or the packing containing it, using unsuitable lifting systems or accessories or with the load unbalanced.
Chemical (refrigerant gas)	Inhalation of refrigerant gas. Therefore always refer to the appliance labels.

IMPORTANT



In case of a significant anomaly (e.g. short circuits, wires coming out of the terminal block, motor breakdowns, worn electrical cable sheathing, etc.) the operator must immediately deactivate the machine.

1.9 Product loading and unloading

WARNING



- Do not use mechanical devices or other means to speed up the defrost process, unless recommended by the manufacturer.
- Do not damage the circuit.

1.10 Machine cleaning and maintenance

- Before carrying out any cleaning or maintenance, disconnect the appliance from the power supply. For details see the Electrical Connection paragraph in this manual.
- Do not touch the appliance with wet hands or feet or when barefoot.
- Do not remove the safety guards.
- Use suitable personal protection equipment.

Ordinary maintenance

- Disconnect the power supply before cleaning the appliance. For details see the Electrical Connection paragraph in the manual.
- Do not clean the machine with jets of water.

Precaution in case of long idle periods

- Machine maintenance, checking and overhaul operations must only be carried out by specialised personnel or the After-Sales Service, provided with adequate personal protection equipment, tools and ancillary means.
- Work on the electrical equipment must only be carried out by specialised personnel or the After-Sales Service.
- Put the machine in safe conditions before starting any maintenance operation.
- Respect the requirements for the various routine and extraordinary maintenance operations. Non-compliance with the instructions can create risks for personnel.

Extraordinary maintenance

- Extraordinary maintenance must be carried out by specialised personnel, who can ask the Manufacturer to supply a servicing manual, or by the After-Sales Service.

1.11 Service

- Only original spare parts can ensure the safety standards of the appliance.
- Only repairs undertaken by an Electrolux approved service technician are covered by the guarantee.

1.12 Dismantling

- ▶ Dismantling operations must be carried out by specialised personnel.
- ▶ Work on the electrical equipment must only be carried out by specialised personnel, with the power supply disconnected.
- ▶ Make the appliance unusable by removing the power cable and any compartment closing devices, to prevent the possibility of someone becoming trapped inside.

2. General information



WARNING Refer to “Warning and Safety Information”

2.1 Introduction

Given below is some information regarding the machine's intended use, its testing, and a description of the symbols used (that identify the type of warning), the definitions of terms used in the manual and useful information for the appliance user.

2.2 Additional indications

The drawings and diagrams given in the manual are not in scale. They supplement the written information with an outline, but are not intended to be a detailed representation of the machine supplied.

The numerical values given on the machine installation diagrams refer to measurements in millimeters and/or inches.

2.3 Intended use and restrictions

This appliance is designed for refrigeration and preservation of bottles of wine. Any other use is deemed improper.



CAUTION The machine is not suitable for installation outdoors and/or in places exposed to atmospheric agents (rain, direct sunlight, etc.).

The manufacturer declines any liability for improper use of the product.

2.4 Testing and inspection

Our appliances are designed and optimised, with laboratory testing, in order to obtain high performance and efficiency.

The product is shipped ready for use.

Passing of the tests (visual inspection - electrical test - functional test) is guaranteed and certified by the specific enclosures.

2.5 Mechanical safety characteristics, hazards

The appliance does not have sharp edges or protruding parts.

The guards for the moving and live parts are fixed to the cabinet with screws, to prevent accidental access.

2.6 Copyright

This manual is intended solely for consultation by the operator and can only be given to third parties with the permission of Electrolux Professional Inc.

2.7 Keeping the manual

The manual must be carefully kept for the entire life of the machine, until scrapping. The manual must stay with the machine in case of transfer, sale, hire, granting of use or leasing.

2.8 Recipients of the manual

This manual is intended for:

- ▶ the carrier and handling personnel;
- ▶ installation and commissioning personnel;
- ▶ the employer of machine users and the workplace manager;
- ▶ operators for normal machine use;
- ▶ specialised technicians - after-sales service (see service manual).

2.9 Definitions

Listed below are the definitions of the main terms used in the manual. Read them carefully before use.

Operator

machine installation, adjustment, use, maintenance, cleaning, repair and transport personnel.

Manufacturer

Electrolux Professional Inc.

Operator for normal machine use

an operator who has been informed and trained regarding the tasks and hazards involved in normal machine use.

Technical assistance or specialised technician

an operator instructed/trained by the Manufacturer and who, based on his professional and specific training, experience and knowledge of the accident-prevention regulations, is able to appraise the operations to be carried out on the machine and recognise and prevent any risks. His professionalism covers the mechanical, electrotechnical and electronics fields.

Danger

source of possible injury or harm to health.

Hazardous situation

any situation where an operator is exposed to one or more hazards.

Risk

a combination of probabilities and risks of injury or harm to health in a hazardous situation.

Protection devices

safety measures consisting of the use of specific technical means (guards and safety devices) for protecting operators against risks.

Guard

an element of a machine used in a specific way to provide protection by means of a physical barrier.

Safety device

a device (other than a guard) that eliminates or reduces the risk; it can be used alone or in combination with a guard.

Customer



the person who purchased the machine and/or who manages and uses it (e.g. company, entrepreneur, firm).

Electrocution

an accidental discharge of electric current on a human body.

2.10 Machine and manufacturer's identification data

A reproduction of the marking or dataplate on the machine is given below:

F.Mod. JG45A-R	Comm.Mod. V405GEBK	TypeRef.	2017
PNC 9EXT720000	Ser.No. 74810001	Cyclopentane	
WTon. 0.1kW	Volt220V ~ 50Hz	TotalCurrent0.55A	
Refrigerante/Refrigerant R600a	0.035kg.	Classe/Class ST	MADE IN CHINA
Illuminazione/Lighting 0.7w Cap			
NFnominal Charge			
GWP CO2-eq 0 t			
Electrolux Professional SpA-Viale Treviso,15-33170 Pordenone (Italy) 			

The data plate gives the product identification and technical data.

When installing the appliance, make sure the electrical connection is carried out in compliance with that specified on the data plate.

2.11 Responsibility

The Manufacturer declines any liability for damage and malfunctioning caused by:

- ▶ non-compliance with the instructions contained in this manual;
- ▶ repairs not carried out in a workmanlike fashion, and replacements with parts different from those specified in the spare parts catalogue (the fitting and use of non-original spare parts and accessories can negatively affect machine operation and invalidates the warranty);
- ▶ operations by non-specialised technicians;
- ▶ unauthorised modifications or operations;
- ▶ inadequate maintenance;
- ▶ improper machine use;
- ▶ unforeseeable extraordinary events;
- ▶ use of the machine by uninformed and untrained personnel;
- ▶ non-application of the current provisions in the country of use, concerning safety, hygiene and health in the workplace.

The Manufacturer declines any liability for damage caused by arbitrary modifications and conversions carried out by the user or the Customer.

The employer, workplace manager or service technician are responsible for identifying and choosing adequate and suitable personal protection equipment to be worn by operators, in compliance with regulations in force in the country of use.

Electrolux Professional SPA declines any liability for inaccuracies contained in the manual, if due to printing or translation errors. Any supplements to the installation, use and maintenance manual the Customer receives from the Manufacturer will form an integral part of the manual and therefore must be kept together with it.

3. Normal machine use

WARNING Refer to "Warning and Safety Information"

3.1 Characteristics of personnel trained for normal machine use

The Customer must make sure the personnel for normal machine use are adequately trained and skilled in their duties, as well as ensuring their own safety and that of other persons.

The Customer must make sure his personnel have understood the instructions received and in particular those regarding work hygiene and safety in use of the machine.

3.2 Characteristics of personnel enabled to operate on the machine

The Customer is responsible for ensuring that persons assigned to the various duties:

- ▶ read and understand the manual;
- ▶ receive adequate training and instruction for their duties in order to perform them safely;
- ▶ receive specific training for correct machine use.

3.3 Operator qualified for normal machine use

He must have at least:

- ▶ knowledge of the technology and specific experience in operating the machine;
- ▶ adequate general basic education and technical knowledge for reading and understanding the contents of the manual;
- ▶ including correct interpretation of the drawings, signs and pictograms;
- ▶ sufficient technical knowledge for safely performing his duties as specified in the manual;
- ▶ knowledge of the regulations on work hygiene and safety.

In case of a significant anomaly (e.g. short circuits, wires coming out of the terminal block, motor breakdowns, worn electrical cable sheathing, etc.) the operator for normal machine use must:

- ▶ immediately deactivate the machine.

4. Transport, handling and storage



WARNING Refer to “Warning and Safety Information”

4.1 Introduction

Transport (i.e. transfer of the machine from one place to another) and handling (i.e. transfer inside workplaces) must occur with the use of special and adequate means.

CAUTION

The machine must only be transported, handled and stored by specialised personnel, who must have:

- ▶ specific technical training and experience in the use of lifting systems;
- ▶ knowledge of the safety regulations and applicable laws in the relevant sector;
- ▶ knowledge of the general safety rules;
- ▶ personal protection equipment suitable for the type of operation carried out;
- ▶ the ability to recognise and avoid any possible hazard.

4.2 Handling

Arrange a suitable area with flat floor for machine unloading and storage operations.

4.3 Procedures for handling operations

Before lifting:

- ▶ send all operators to a safe position and prevent persons from entering the handling area;
- ▶ make sure the load is stable;
- ▶ make sure no material can fall during lifting.
- ▶ handle the machine, keeping it at minimum height from the ground.

For correct and safe lifting operations:

- ▶ use the type of equipment most suitable for characteristics and capacity (e.g. electric pallet truck or lift truck);
- ▶ cover sharp edges;
- ▶ check the forks and lifting procedures according to the instructions given on the packing.



WARNING
For machine lifting and anchoring, do not use movable or weak parts such as: casings, electrical raceways, pneumatic parts, etc.

4.4 Shifting

The operator must:

- ▶ have a general view of the path to be followed;
- ▶ stop the manoeuvre in case of hazardous situations.



WARNING
Do not push or pull the appliance to move it, as it may tip over.

4.5 Placing the load

Before placing the load, make sure the way is free and that the floor is flat and can take the load.

4.6 Unpacking



IMPORTANT
Immediately check for any damage caused during transport. Inspect the packaging before and after unloading.

Remove the packaging. Take care when unpacking and handling of the appliance to not cause any shocks on itself.

Keep all the documentation contained in the packaging.

NOTE

- ▶ The forwarder is responsible for the goods during transport and delivery.
- ▶ Make a complaint to the forwarder in case of visible or hidden damage.
- ▶ Specify any damage or shortages on the dispatch note.
- ▶ The driver must sign the dispatch note: the forwarder can reject the claim if the dispatch note is not signed (the forwarder can provide the necessary form).
- ▶ For hidden damage or shortages becoming apparent only after unpacking, request the forwarder for inspection of the goods within and no later than 15 days after delivery.

4.7 Storage

The machine and/or its parts must be stored and protected against damp, in a non-aggressive place free of vibrations and with room temperature between 14°F (-10°C) and 122°F (50°C). The place where the machine is stored must have a flat support surface in order to avoid any twisting of the machine or damage to the support feet.

CAUTION



Do not make modifications to the parts supplied with the appliance. Any missing or faulty parts must be replaced with original parts.

5. Technical data

WARNING



Refer to “Warning and Safety Information”

6. Installation and assembly

WARNING



Refer to “Warning and Safety Information”

6.1 Introduction

To ensure correct operation of the appliance and maintain safe conditions during use, carefully follow the instructions given below in this section.

WARNING



Wear protective gloves and unpack the machine, carrying out the following operations.

CAUTION



Before moving the appliance make sure the load bearing capacity of the lifting equipment used is suitable for its weight.

6.2 Installing your wine cellar

Unpack and remove all of the protection and adhesive strips from the packaging around and inside the wine cellar.

The wine cellar must be positioned such that the plug is accessible. Release the power cord. Move your wine cellar to its final location. The wine cellar should be installed in a suitable place where the compressor will not be subject to physical contact.

Leveling your wine cellar:

Wine cellar must be leveled **BEFORE** loading your wines.

Your wine cellar is equipped with 4 adjustable feet to facilitate easy leveling. The Manufacturer recommends that you tighten the back feet to the maximum and adjust the front feet to level the wine cellar.

Fixing the back spacer:

Compressor run appliances require proper ventilation for proper and longer usage. Your wine cellar is supplied with a back spacer. Affix the back spacer at the back of the cellar for air circulation and heat evacuation.

INSTALLATION OF BACK SPACER

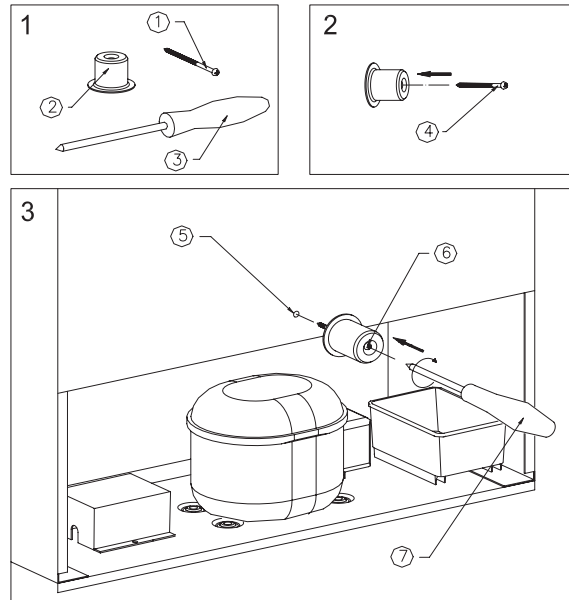

IMPORTANT



THIS SPACER MUST BE ATTACHED TO THE UNIT BEFORE THE INSTALLATION, FOR VENTILATION PURPOSE. FAILURE TO DO SO VOIDS THE WARRANTY.

6.3 Installation instructions for built-in wine cellar

- ▶ “Built-in” wine cellars are front venting but are not designed to be fully integrated behind a joinery door.
- ▶ “Built-in” wine cellars require 10mm clearance on both sides and top, 30mm clearance at the rear (back spacer is provided), to facilitate installation, removal, servicing and ventilation.
- ▶ “Built-in” wine cellars draw air from the rear and expels through the metal grid under the door at the front. If a kick board is to be placed in front of the wine cellar’s grid another one must be fitted into the kick board with a minimum air flow allowance of 150cm².

- ▶ “Built-in” wine cellars have a power switch located on the control panel so power point location is not critical.
- ▶ The wine cellar requires a standard 240 volt/10 amp power point (or according to different countries specifications).
- ▶ The power cord is 1.9m in length and is fixed on the right side at the back when looking from front of cabinet.
- ▶ As with most appliances of today, the wine cellar has sensitive electronic components which are susceptible to damage through lightning and electricity supply faults. It is therefore advised to use a power surge protector to avoid problems of this nature.
- ▶ Air vent within the joinery must be provided for “built-in” wine cellars (front venting).

In Hot climate zone, an air vent or grid, with a minimum ventilation size of 200mm x 40mm MUST be cut out at the rear top of the back partitioning or at the top of either side of the partitioning, allowing cool fresh air full access to flow into the 30mm gap located at the rear of the cabinet.

This air vent or grid must not be opened on the same side as other appliances such as ovens or an area that is sealed and without access to fresh cool air. Failing to comply with the above specifications could result in WARRANTY void.

6.4 Installation drawings for built-in wine cellars

Machine space limits

Make sure to position the appliance following the indications given in the drawing below,, also taking into consideration the space needed for door opening.

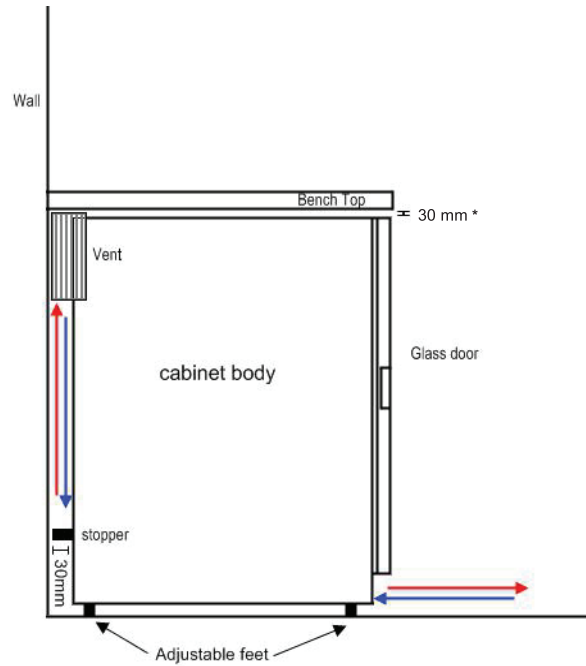
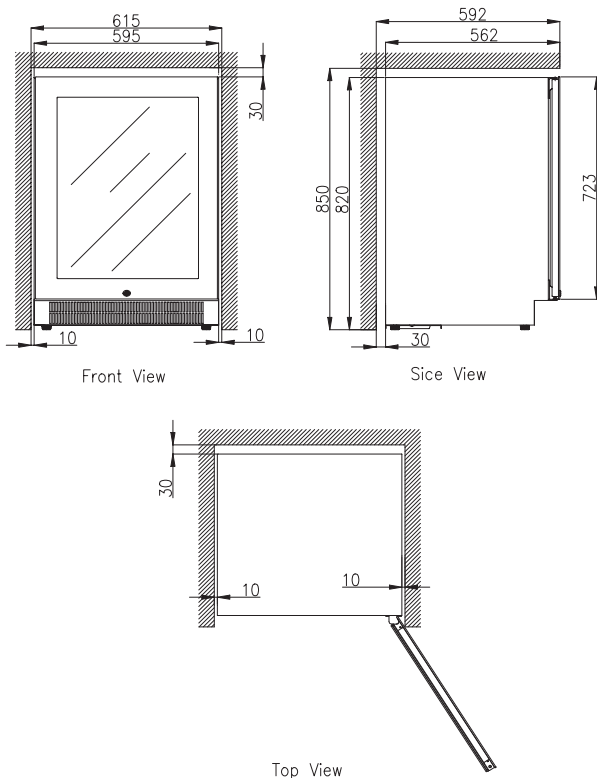

6.3 Before loading & plugging in the wine cellar

Install the appliance, taking all the safety precautions required for this type of operation, also respecting the relevant fire-prevention instructions.

Recommendations:

The location you have selected for your wine cellar should:

- ▶ be unencumbered and well ventilated;
- ▶ be well away from any heat source and direct sunlight;
- ▶ not be too damp (laundry, pantry, bathroom etc.);
- ▶ have a flat floor;
- ▶ have a standard and reliable electricity supply (standard socket to country standards, linked to the ground), it is NOT recommended to use a multi-socket or extension lead;
- ▶ have a surge protector fitted to the electrical outlet;
- ▶ away from the microwave oven. Certain microwave ovens do not have wave interference shield. When placed within 1 meter vicinity of the wine cabinet, they may affect the operation of the wine cabinet.

The wine cellar should be placed where the ambient temperature is between 5°C to 35°C. If the ambient temperature is above or below this range, the performance of the unit may be affected. Placing your unit in extreme cold or hot conditions may cause interior temperatures to fluctuate. The ideal range of temperature may not be reached (see “Climate Class”).



When positioning to take into account the following distances:

- ▶ at least 30 mm from the top and back;
- ▶ 10 mm from the sides.

This space must be increased in case of use and/or transfer of other equipment and/or means or if exit routes are necessary

inside the workplace. There must be free air circulation above the appliance, at the refrigerating unit. There must be no obstructions caused by trays, cardboard boxes, jars or other materials. Never cover the condenser, even temporarily, as this can compromise proper operation of the condenser and therefore the appliance.

The machine must be taken to the place of installation and the packing base removed only when being installed.

Arranging the machine:

- ▶ position the machine in the required place;
- ▶ make sure the appliance is levelled also checking correct door closing.

The appliance must be levelled, otherwise its operation could be affected.



WARNING

 Wait at least 2 hours before starting the appliance, to allow the oil to flow back into the compressor.

6.7 Disposal of packing

The packing must be disposed of in compliance with the current regulations in the country where the appliance is used.

All the packing materials are environmentally friendly. They can be safely kept, recycled or burned in an appropriate waste incineration plant. Recyclable plastic parts are marked as follows:

 PE	polyethylene:	outer wrapping, instruction booklet bag
 PP	polypropylene:	straps
 PS	polystyrene foam:	corner protectors

The parts in wood and cardboard can be disposed of, respecting the current regulations in the country where the machine is used.

7. Appliance start-up

WARNING

 **Refer to “Warning and Safety Information”**

7.1 Turning on your wine cellar

Plug in and switch on the cellar by pressing on the power button **for a few seconds**.

When you use the wine cellar for the first time (or restart the wine cellar after having it shut off for a long time), there will be a few degrees variance between the temperature you have selected and the one indicated on the LED readout. This is normal and it is due to the length of the activation time. Once the wine cellar is running for a few hours everything will stabilize.

IMPORTANT

 *If the unit is unplugged, power is lost, or turned off, wait 3 to 5 minutes before restarting the unit. The wine cellar will not start if you attempt to restart before this time delay.*

Operating noises:

To reach the desired temperature settings, wine cellars, like all wine cellars operating with compressors and fans, may produce the following types of noises. These noises are normal and may occur as follows:

Gurgling sound - caused by the refrigerant flowing through the appliance's coils.

Cracking/popping sounds - resulting from the contraction and expansion of the refrigerant gas to produce cold.

Fan operating sound - to circulate the air within the wine cellar.

An individual's perception of noise is directly linked to the environment in which the wine cellar is located, as well the specific type of models. These wine cellars are in line with international standards for such appliance. The Manufacturer will always do its utmost to satisfy its customers but will not retake possession of the goods due to complaints based on normal operating noise occurrences.

8. Features



WARNING Refer to “Warning and Safety Information”

8.1 Loading your wine cellar

You may load your wine bottles in single or double rows while taking note of the following: if you do not have enough bottles to fill your wine cellar, it is better to distribute the load throughout the wine cellar so as to avoid “all on top” or “all below” type loads.

- ▶ Do not remove or relocate adjustable wooden shelves to accommodate larger type of bottles or increase the capacity of the cellar by stacking the bottles up when necessary (see removing shelves).
- ▶ Keep small gaps between the walls and the bottles to allow air circulation. Like an underground cellar air circulation is important to prevent mould and for a better homogeneous temperature within the cellar.
- ▶ Do not over load your wine cellar to facilitate air circulation.
- ▶ Do not stack more than 1.5 rows of standard 0.75L bottles per shelves to facilitate air circulation
- ▶ Avoid obstructing the internal fans (located inside on the back panel of the wine cellar). Do not slide the shelves outwards beyond the fixed position to prevent the bottles from falling.
- ▶ Do not pull out more than one loaded shelf at a time as this may cause the wine cellar to tilt forward.
- ▶ Do not cover the wooden shelves with alloy foil or other materials, as it will obstruct air circulation.
- ▶ Do not move your wine cellar while it is loaded with wines. This might distort the body of the wine cellar and cause back injury.

8.2 Types of regulation

Please note that depending on the loading and settings chosen it takes about 24 hours for the wine cellar to see the temperature stabilizing.

During this time LED seems to move erratically in particular for 2e models. It is normal and this process occurs whenever the setting is modified and/or whenever a large amount of bottles are added to the cellar.

Electronic regulation, digital display.

Designed to store and mature all wines: red, white and sparkling. These wine cellars reproduce the ideal conditions for wine storage, at a constant recommended temperature of 12°C. They can also be set to provide ideal serving temperature for full enjoyment of the wine's qualities. Unless stated by the wine maker on the bottle, the Manufacturer recommends 7°C for your champagne, 12°C for whites and 18°C for reds. (Refer to “Wine Service Temperature” recommendation chart).

8.3 Temperature settings



IMPORTANT

The LCD displays by default the actual internal air temperature.

The temperature settings are preset at the factory as follows. In the event of a power interruption, all previous temperature settings are automatically erased and it will revert to the preset temperature settings.

Factory preset chart:

Model	Setting	Temperature
WC50BK1Z	12	12°C(+/-2.5°C)

It is important to understand that there is a difference between the air temperature inside the wine cellar and the actual temperature of the wine: you will need to wait approximately 12 hours before noticing the effects of temperature adjustment due to the critical mass within a full wine cellar.

Once the temperature is set, it is strongly advised not to toy with it or adjust frequently.

The thermostat will maintain the temperature inside the wine cellar within a +/- 2.5°C range. But the thermal inertia of the wine and the glass is such that within this temperature range, the actual temperature of the wine will only fluctuate 0.5°C to 1°C.

8.4 Wine serving temperature chart

All wines mature at the same temperature, which is a constant temperature set between 12°C to 14°C. The below chart is an indicative temperature chart to indicate the best temperature for drinking purposes.

Champagne NV, Sparkling, Spumante	6-8°C
Dry White Semillon, Sauvignon Blanc	8-10°C
Champagne Vintage	10-12°C
Dry White Chardonnay	10-12°C
Dry White Gewürztraminer, Riesling, Pinot grigio	10-12°C
Sweet White Sauternes, Barsac, Montbazillac, Ice Wine, Late Harvest	10-12°C
Beaujolais	13°C
Sweet White Vintage: Sauternes...	14°C
White Vintage Chardonnay	14°C
Red Pinot Noir	16°C
Red Grenache, Syrah	16°C
Red Vintage Pinot Noir	18°C

Cabernet & Merlot: French, Australian, New Zealand	20°C
Chilean, Italian, Spanish, Californian, Argentinean, Vintage Bordeaux ...	Room temperature not exceeding 20°C

8.5 Important information about temperature

Your wine cellar has been designed to guarantee optimum conditions for storing and/or serving your wines.

Fine wines require long and gentle developments and need specific conditions in which to reach their full potential.

All wines mature at the same temperature, which is a constant temperature set between 12°C to 14°C. Only the temperature of "dégustation" (wine appreciation) varies according to the type of wines (see "Wine Serving Temperature Chart" above). This being said and as it is for natural cellars used by wine producers for long period of storage, it is not the exact temperature that is important, but its consistency. In other words, as long as the temperature of your wine cellar is constant (between 12°C to 14°C) your wines will be stored in perfect conditions.

Not all wines will improve over the years. Some should be consumed at an early stage (2 to 3 years) while others have tremendous ageing capability (50 and over). All wines have a peak in maturity. Do check with your wine merchant to get the relevant information.

8.6 Defrosting/condensation/hygroscopy/ventilation

Your wine cellar is designed with "Auto-cycle" defrost system. During "Off-cycle" the refrigerated surfaces of the wine cellar defrost automatically. Defrost water from the wine cellar storage compartment drains automatically and part of it goes into a drainage container, which is located at the back of the wine cellar next to the compressor. The heat is transferred from the compressor and evaporates any condensation that has collected in the pan. Part of the remaining water is collected within the wine cellar for humidity purposes.

This system enables the creation of the correct humidity level inside your wine cellar required by the natural cork to maintain a long lasting seal.

Notes: *the water collected by condensation, is therefore recycled. Under extremely dry environmental conditions, you may have to add some water into the water container provided with your wine cellar.*

All units are equipped with a double glazed glass door that has a third internal acrylic layer to minimize condensation on the glass door.

The wine cellar is not totally sealed; fresh air admission is permitted through the drainpipe. Air is circulated through the cellar by means of a fan/fans and the hollow shelves.

Notes: *during the refrigerating cycle, heat is given off and disperses through the external surfaces of the wine cellar. Avoid touching the surfaces during those cycles.*

8.7 Adjustable wooden shelves

Adjusting/removing the shelves:

For easy access to the storage content, you must pull the shelves approximately 1/3 of its depth out of the rail compartment. These wine cabinets, however, are designed with a notch on each side of the shelf tracks to prevent bottles from falling.

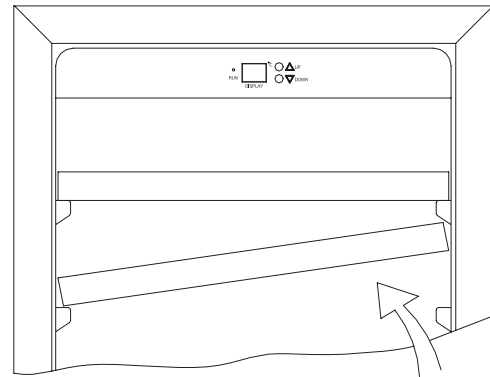

WARNING

The appliance is supplied complete with the lock kit and keys. It is advisable to keep the keys in a place only accessible to authorised personnel. To prevent unauthorised personnel from using the appliance, it is advisable to always close it with the key.

9. Care

WARNING

Refer to "Warning and Safety Information"

10. Power failure

 **WARNING**
Refer to “Warning and Safety Information”

10.1 Power failures

In the event of a power interruption, all previous temperature settings are automatically erased and it will revert to a preset temperature setting (see preset chart).

Most power failures are corrected within a short period of time. An hour or two's loss of power will not affect wine cellar's temperatures. To avoid sudden change of temperature while the power is off, you should avoid opening the door. For longer period of power failure, do take steps to protect your wine.

Irrespective of the cause, if you notice either abnormal temperature or humidity levels inside your wine cellar, be reassured that only long and frequent exposure to these abnormal conditions can cause a detrimental effect on your wines.

11. Machine cleaning and maintenance

 **WARNING**
Refer to “Warning and Safety Information”

11.1 Ordinary maintenance

11.1.1 Precautions for maintenance

 **CAUTION**
The manufacturer declines any liability for operations carried out on the machine without following these instructions.

11.1.2 Cleaning the cabinet and accessories

Before using the appliance, clean all the internal parts and accessories with lukewarm water and neutral soap or products that are over 90% biodegradable (in order to reduce the emission

of pollutants into the environment), then rinse and dry thoroughly. Do not use solvent-based detergents (e.g. trichloro-ethylene) or abrasive powders for cleaning. The shelves can be removed in order to thoroughly clean the compartment, therefore remove it before cleaning.

Check the power cable regularly and replace it in case of signs of wear.

Have the appliance checked periodically (at least once a year).

 **WARNING**
Do not clean the machine with jets of water.

 **CAUTION**
Do not use steel wool or similar material to clean. Do not use detergents containing chlorine, solvent-based detergents (e.g. trichloro-ethylene) or abrasive powders or agents, scouring pads or sponges that could damage the surface. Do not use organic solvent substances or essential oils. These substances could damage the parts of the appliance made from synthetic material.

Do not use products (even if diluted) containing chlorine (sodium hypochlorite, hydrochloric or muriatic acid, etc.) to clean the floor under the appliance.



After carrying out maintenance make sure the machine is able to work safely and, in particular, that the protection and safety devices are efficient.

11.2 Extraordinary maintenance

NOTE
Extraordinary maintenance must be carried out by specialised personnel, who can ask the manufacturer to supply a servicing manual.

11.2.1 Maintenance intervals

The inspection and maintenance intervals depend on the actual machine operating conditions and ambient conditions (presence of dust, damp, etc.), therefore precise time intervals cannot be given. In any case, careful and periodical machine maintenance is advisable in order to minimise service interruptions. It is advisable to carry out the checks with the frequency given in the following table.

Maintenance, inspections, checks and cleaning	Frequency	Responsibility
Routine cleaning general cleaning of machine and surrounding area	daily	Operator
Mechanical protection devices check their condition and for any deformation, loosening or removed parts	monthly	Service
Door frame and Gasket Check the integrity status of the door frame and door gasket. Check the cleanliness of the door frame and door gasket. Replace in case broken	monthly	Service
Control check the mechanical part, for cracks or deformation, tightening of screws: check the readability and condition of words, stickers and symbols and restore if necessary	yearly	Service
Machine structure tightening of main bolts (screws, fixing systems, etc.) of machine	yearly	Service
Safety signs check the readability and condition of safety signs	yearly	Service

Electrical control panel check the electrical components installed inside the electrical control panel. Check the wiring between the electrical panel and machine parts.	yearly	Service
Electrical connection cable and plug check the connection cable (replace if necessary) and plug	yearly	Service
General machine overhaul check all components, electrical equipment, corrosion, pipes...	every 10 years*	Service

(*)The machine must undergo a general inspection and overhaul. Some examples of checks to be carried out are given below.

- ▶ check for any oxidised electrical components or parts; if necessary, replace them and restore the initial conditions;
- ▶ check the structure and welded joints in particular;
- ▶ check and replace bolts and/or screws, also checking for any loose components;
- ▶ check the electrical and electronic system;
- ▶ check the functionality of safety devices;
- ▶ check the general condition of protection devices and guards.

NOTE
It is advisable to stipulate a preventive and scheduled maintenance contract with the After-Sales Service.

12. Machine disposal

WARNING
Refer to "Warning and Safety Information"

12.1 Waste storage

At the end of the product's life-cycle, make sure it is not dispersed in the environment. The doors must be removed before scrapping the appliance.

SPECIAL waste materials can be stored temporarily while awaiting treatment for disposal and/or permanent storage.

In any case, the current environmental protection laws in the country of use must be observed.

12.2 Procedure regarding appliance dismantling macro operations

Before disposing of the machine, make sure to carefully check its physical condition, and in particular any parts of the structure that can give or break during scrapping.

The machine's parts must be disposed of in a differentiated way, according to their different characteristics (e.g. metals, oils, greases, plastic, rubber, etc.).

Different regulations are in force in the various countries, therefore

comply with the provisions of the laws and competent bodies in the country where scrapping takes place.

In general, the appliance must be taken to a specialised collection/scrapping centre.

Dismantle the appliance, grouping the components according to their chemical characteristics, remembering that the compressor contains lubricant oil and refrigerant fluid which can be recycled, and that the refrigerator components are special waste assimilable with urban waste.



The symbol on the product indicates that this product should not be treated as domestic waste, but must be correctly disposed of in order to prevent any negative consequences for the environment and human health.

For further information on the recycling of this product, contact the local dealer or agent, the after-sales service or the local body responsible for waste disposal.

NOTE



When scrapping the machine, the data plate, this manual and other documents concerning the appliance must be destroyed.

13. Enclosed documents

- ▶ Wiring diagram (included in dataplate)
- ▶ Installation diagram
- ▶ Declaration of Conformity

14. Troubleshooting guide

Operation anomalies

Ensure that there is power to the electrical supply plug by connecting another electrical appliance to it. Check fuse, if any. Make sure that the door is closed properly.

If your wine cellar appears to be malfunctioning, unplug it and contact your after sales service. Any intervention on the cold circuit should be performed by a refrigeration technician who should carry out an inspection of the circuit sealing system. Similarly, any intervention on the electrical circuit should be performed by a qualified electrician.

Notes: any intervention performed by a non-authorized technician by the Manufacturer will lead to the warranty being considered as null and void.

Common problems may easily be solved, saving you the cost of a possible service call. Please read carefully the instruction manual and revert to troubleshooting guide chart.

PROBLEM	POSSIBLE CAUSE
Wine cellar does not operate.	<ul style="list-style-type: none"> ▶ Not plugged in. ▶ The appliance is turned off. ▶ The circuit breaker tripped or the fuse is broken.
Wine cellar is not cold enough.	<ul style="list-style-type: none"> ▶ Check the temperature control setting. ▶ External environment may require a higher setting. ▶ The door is opened too often. ▶ The door is not closed completely. ▶ The door gasket does not seal properly.
Turns on and off frequently.	<ul style="list-style-type: none"> ▶ The room temperature is hotter than normal. ▶ A large amount of contents has been added to the wine cellar. ▶ The door is opened too often. ▶ The door is not closed completely. ▶ The temperature control is not set correctly. ▶ The door gasket does not seal properly.
The light does not work.	<ul style="list-style-type: none"> ▶ Not plugged in. ▶ The circuit breaker tripped or a blown fuse. ▶ The bulb is out of order. ▶ The light button is "OFF":
Vibrations.	<ul style="list-style-type: none"> ▶ Check to assure that the wine cellar is level.
The wine cellar seems to make too much noise.	<ul style="list-style-type: none"> ▶ The rattling noise may come from the flow of the refrigerant, which is normal. ▶ As each cycle ends, you may hear gurgling sounds caused by the flow of refrigerant in your wine cellar. ▶ Contraction and expansion of the inside walls may cause popping and crackling noises. ▶ The wine cellar is not level.
The door will not close properly.	<ul style="list-style-type: none"> ▶ The wine cellar is not level. ▶ The door was reversed and not properly installed. ▶ The gasket is faulty (magnet or rubber is spoiled). ▶ The shelves are out of position.

If the fault persists after carrying out the above checks, contact the After-Sales Service, remembering to specify:

- 1. the type of fault;**
- 2. the appliance PNC (product number code);**
- 3. the Ser.No. (appliance serial number).**

NOTE



The appliance PNC and serial number are essential for identifying the type of appliance and date of manufacture. The dataplate giving the product and technical data is located inside the appliance.

When installing the appliance, make sure the electrical connection is carried out in compliance with that specified on the data plate.