

STELLA EPIC



EN User manual *



*Original instructions

SE9020- 2021.01

Installation diagram

EPIC 2

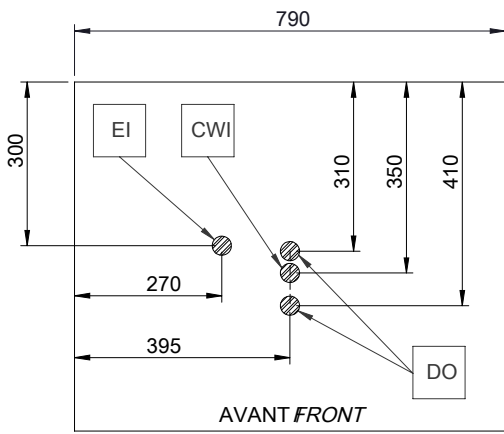
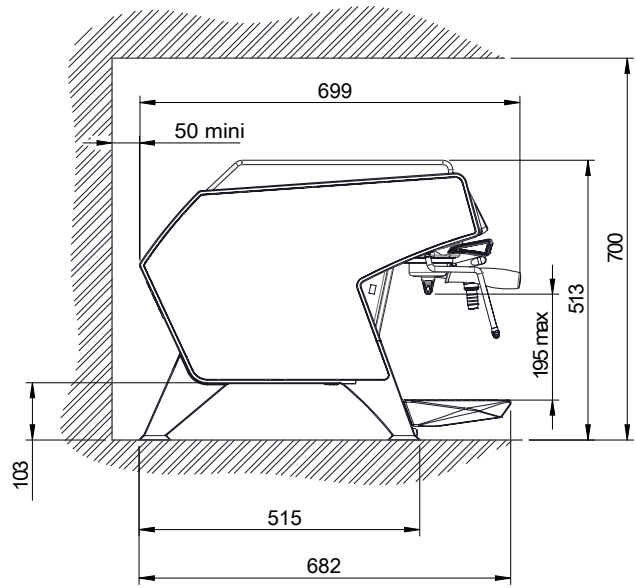
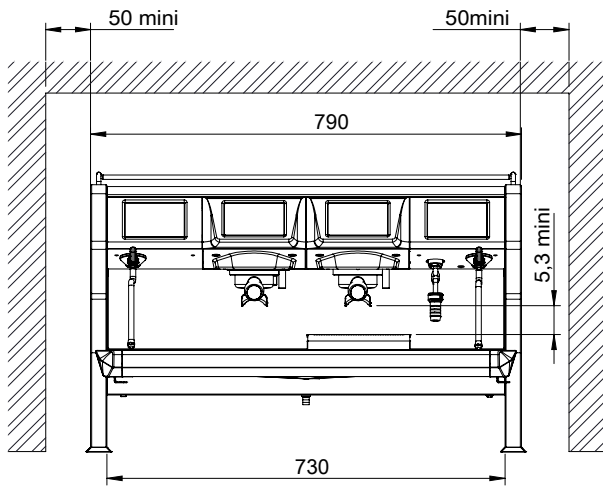

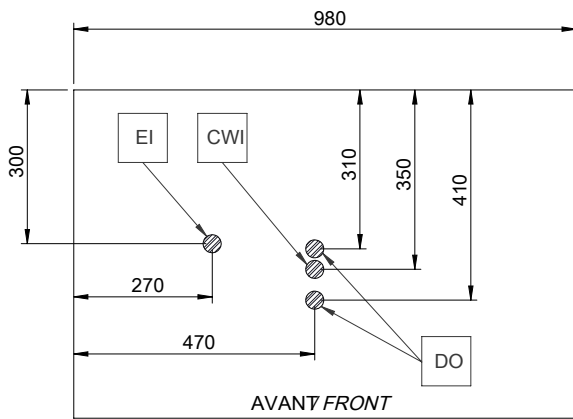
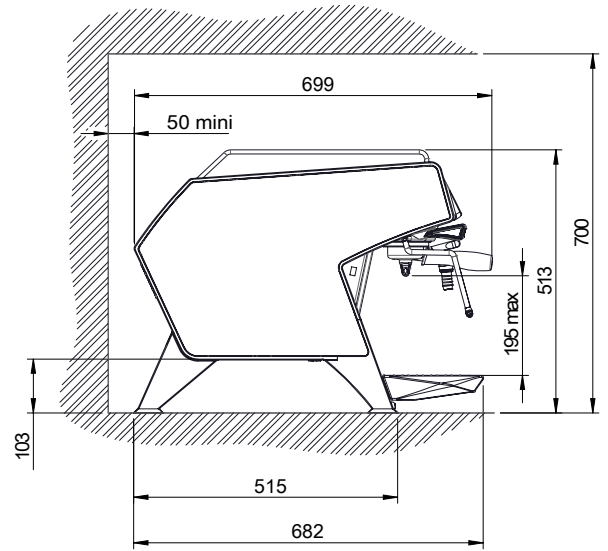
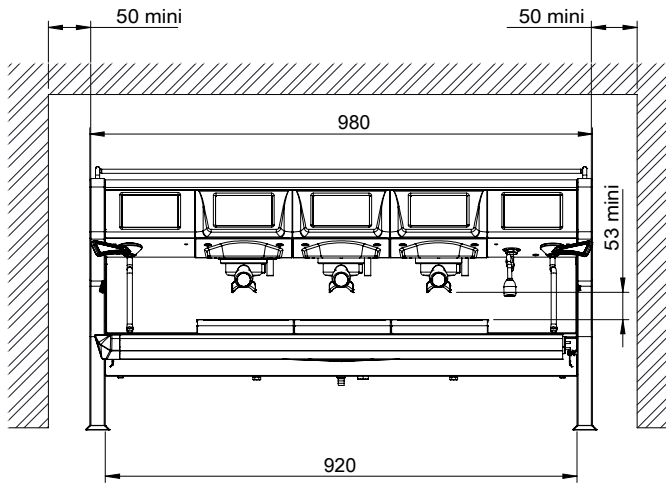

DO = Drain outlet
EI = Electricity inlet

CWI = Cold water inlet G 3/8"

Foreword



The installation, use and maintenance manual (hereinafter Manual) provides the user with information necessary for correct and safe use of the machine (or "appliance").

The following must not be considered a long and exacting list of warnings, but rather a set of instructions suitable for improving machine performance in every respect and, above all, preventing injury to persons and animals and damage to property due to improper operating procedures.

All persons involved in machine transport, installation, commissioning, use and maintenance, repair and disassembly must consult and carefully read this manual before carrying out the various operations, in order to avoid wrong and improper actions that could compromise the machine's integrity or endanger people. Make sure to periodically inform the user regarding the safety regulations. It is also important to instruct and update personnel authorised to operate on the machine, regarding its use and maintenance.

The manual must be available to operators and carefully kept in the place where the machine is used, so that it is always at hand for consultation in case of doubts or whenever required.

If, after reading this manual, there are still doubts regarding machine use, do not hesitate to contact the Manufacturer or the authorised Service Centre to receive prompt and precise assistance for better operation and maximum efficiency of the machine. During all stages of machine use, always respect the current regulations on safety, work hygiene and environmental protection. It is the user's responsibility to make sure the machine is started and operated only in optimum conditions of safety for people, animals and property.



IMPORTANT

- The manufacturer declines any liability for operations carried out on the appliance without respecting the instructions given in this manual.
- The manufacturer reserves the right to modify the appliances presented in this publication without notice.
- No part of this manual may be reproduced.
- This manual is available in digital format by:
 - contacting the dealer or reference customer care;
 - downloading the latest and up to date manual on the web site;
- The manual must always be kept in an easily accessed place near the machine. Machine operators and maintenance personnel must be able to easily find and consult it at any time.

Contents

A	SAFETY INFORMATION	7
A.1	General information	7
A.2	General safety	7
A.3	Personal protection equipment	8
A.4	Transport, handling and storage	8
A.5	Installation and assembly	9
A.6	Water connection	9
A.7	Electrical connection	9
A.8	Use	10
A.9	appliance cleaning and maintenance	10
A.10	Service	10
A.11	Disposal of packing	10
A.12	Machine disposal	11
B	GENERAL SAFETY RULES	11
B.1	Introduction	11
B.2	Mechanical safety characteristics, hazards	11
B.3	Protection devices installed on the machine	11
B.4	Main switch	11
B.4.1	Appliance with 2 positions main switch	11
B.5	Safety signs to be placed on the machine or near its area	11
B.6	Instructions for use and maintenance	11
B.7	Reasonably foreseeable improper use	11
B.8	End of use	12
B.9	Residual risks	12
C	GENERAL INFORMATION	12
C.1	Introduction	12
C.2	Definitions	12
C.3	Machine and manufacturer's identification data	13
C.4	Additional indications	13
C.5	Responsibility	13
C.6	Copyright	13
C.7	Keeping the manual	13
C.8	Recipients of the manual	13
D	NORMAL USE	14
D.1	Characteristics of personnel enabled to operate on the machine	14
D.2	Characteristics of personnel trained for normal machine use	14
D.3	Operator qualified for normal machine use	14
E	TECHNICAL CHARACTERISTICS	14
E.1	Data table	14
F	OPERATING	14
F.1	Switching on	14
F.1.1	Filling the boilers	14
F.1.2	Switching on the heating	15
F.2	BTA description	15
F.2.1	Screen : thermal informations	15
F.2.2	Screen : Quick access / code	15
F.2.3	Various icons	15
F.3	Keyboards	15
F.3.1	Coffee keyboards	15
F.3.2	Service keyboards	16
F.4	How to prepare a cappuccino	16
G	DAILY CLEANING	16
G.1	Cleaning groups	16
G.1.1	Before use or after several hours of inactivity	16
G.1.2	Rinse the decompression circuit	16
G.1.3	Semi automatic cleaning	16
G.2	External cleaning	17
H	MAINTENANCE	17
H.1	Maintenance intervals	17
H.1.1	Preventive Maintenance	17
H.2	Softener	17
H.3	Machine disposal	17
I	STEAMAIR OPTION	18
I.1	Introduction	18
I.2	Components	18
I.3	Use	18
I.3.1	Automatic mode (To reach the programmed T°C)	18
I.3.2	Manual mode (Over the programmed T°C)	18
I.4	Programming	18

A SAFETY INFORMATION

A.1 General information

To ensure safe use of the appliance and a proper understanding of the manual it is necessary to be familiar with the terms and typographical conventions used in the documentation. The following symbols are used in the manual to indicate and identify the various types of hazards:



WARNING

Danger for the health and safety of operators.



WARNING

Danger of electrocution - dangerous voltage.



CAUTION

Risk of damage to the machine or the product.



IMPORTANT

Important instructions or information on the product



Read the instructions before using the appliance







Clarifications and explanations

A.2 General safety

- The machine must not be used by people (including children) with limited physical, sensory or mental abilities or without experience and knowledge of it, unless instructed in its use and supervised by those responsible for their safety.
 - Do not let children play with the machine.
 - Keep all packaging and detergents away from children.
 - Cleaning and user maintenance shall not be made by children without supervision.
- For suitable personal protection equipment, refer to chapter “A.3 *Personal protection equipment*”.
- Several illustrations in the manual show the machine, or parts of it, without guards or with guards removed. This is purely for explanatory purposes. Do not install the machine without the guards or with the protection devices deactivated.
- Do not remove, tamper with or make illegible the safety, danger and instruction signs and labels on the machine.
- Do not remove or tamper with the machine’s safety devices.
- Before carrying out any machine installation, always consult the installation manual, which gives the correct procedures and contains important information on safety.
- Unauthorized personnel must not enter the work area.
- Remove any flammable products or items from the work area.
- Machine positioning, installation and disassembly must be carried out by the specialised personnel in conformity with the current safety regulations, regarding the equipment used and the operating procedures.

A.3 Personal protection equipment

Summary table of the Personal Protection Equipment (PPE) to be used during the various stages of the machine's service life.

Stage	Protective garments 	Safety footwear 	Gloves 	Glasses 	Safety helmet 
Transport	—	●	○	—	○
Handling	—	●	○	—	—
Unpacking	—	●	○	—	—
Installation	○	●	○ ¹	—	—
Normal use	—	○	—	—	—
Adjustments	—	○	○	—	—
Routine cleaning	—	—	○ ²	—	—
Extraordinary cleaning	○	●	○	○	—
Maintenance	○	●	○	○	—
Dismantling	○	●	●	○	—
Scrapping	○	●	●	○	—
Key:					
●	PPE REQUIRED				
○	PPE AVAILABLE OR TO BE USED IF NECESSARY				
—	PPE NOT REQUIRED				

1. During these operations, gloves must be cut-resistant. Failure to use the personal protection equipment by operators, specialized personnel or users can involve exposure to damage to health (depending on the model).
2. During these operations, gloves must be suitable for contact with chemical substances used (refer to the safety data sheet of the substances used for information regarding the required PPE). Failure to use the personal protection equipment by operators, specialized personnel or users can involve exposure to chemical risk and cause possible damage to health (depending on the model).

A.4 Transport, handling and storage

- Due to their size, the machines cannot be stacked on top of each other during transport, handling and storage; this eliminates any risks of loads tipping over due to stacking.
- Do not stand under suspended loads during loading or unloading operations. Unauthorized personnel must not enter the work area.
- The weight of the appliance alone is not sufficient to keep it steady.
- For machine lifting and anchoring, do not use movable or weak parts such as: casings, electrical raceways, pneumatic parts, etc.
- Do not push or pull the machine to move it, as it may tip over. Use proper tool to lift the machine.
- Machine transport, handling and storage personnel must be adequately instructed and trained regarding the use of lifting systems and personal protection equipment suitable for the type of operation carried out.

A.5 Installation and assembly

- The installation must be carried out by a specialised personnel.
- Follow the installation instruction supplied with the appliance.
- Do not install a damaged appliance. Any missing or faulty parts must be replaced with original parts.
- Do not make any modifications to the parts supplied with the appliance.
- Disconnect the appliance from the power supply before carrying out any installation procedure. Connect the appliance to the power supply only at the end of the installation.
- The appliance is not suitable for installation outdoors and/or in places exposed to atmospheric agents (rain, direct sunlight, freeze, humid and dusty location, etc.).
- Make sure that the floor where you install the appliance is flat, stable, heat resistant and clean.
- Access to the service area is limited to persons with the necessary knowledge of safety and hygiene as well as practical experience of the device.
- Leave enough free space around the appliance to facilitate its use and to perform any maintenance operations.

A.6 Water connection

- The plumbing connections must be carried out by a specialised personnel.
- The machine is to be connected to the water mains using the new supplied hose-sets. Do not use old hose sets.
- Always use a new set of joints if you remove and re-install the water inlet pipe to the machine.
- Before connection to new pipes, pipes not used for a long time, where repair work has been carried out or new devices fitted (water meters, etc.), let the water flow until it is clean and clear.
- The dynamic water pressure (minimum and maximum) must be between:
 - 1 bar [0.1 MPa] and 8 bar [0.8 MPa];
- Make sure that there are no visible water leaks during and after the first use of the machine.
- Install an approved dual check valve upstream according to the regulation of the installation country.

A.7 Electrical connection

- Work on the electrical systems must only be carried out by a specialised personnel.
- Make sure that the electrical information on the rating plate agrees with the power supply.
- Make sure to install the appliance in accordance with the safety regulations and local laws of the country where used.
- If the power cable is damaged it must be replaced by the Customer Care Service or in any case by specialised personnel, in order to prevent any risk.
- The appliance must be correctly earthed. The manufacturer is not responsible for the consequences of an inadequate earthing system.
- To protect the power supply of the appliance against short circuits and/or overloads, install a thermal fuse or a suitable automatic thermal magnetic circuit breaker, ADS (Automatic Disconnection of Supply).
- To protect the power supply of the appliance against current leakages, install a high-sensitivity manual reset RCD (Residual Current Device), suitable for overvoltage category III.

For protection against indirect contacts, refer to point 6.3.3 of EN 60204-1 (IEC 60204-1) with the use of protection devices that ensure automatic cut-off of the supply in case of

isolation fault in the TN or TT systems or, for IT systems, the use of isolation controllers or differential current protection devices to activate automatic power disconnection (an isolation controller must be provided for indicating a possible first earth fault of a live part, unless a protection device is supplied for switching off the power in case of a such a fault. This device must activate an acoustic and/or visual signal which must continue for the entire duration of the fault). For example: in a TT system, a residual current device with cut-in current (e.g. 30 mA) coordinated with the earthing system of the building where the appliance is located must be installed ahead of the supply.

A.8 Use

- The appliance must be used in room with an ambient temperature of 5°C to 35°C (41°F - 95°F).
- If it is stored at an ambient temperature below 5°C (41°F) the water circuit (boiler-piping) must be drained.
- In case of emergency (fire, surge, abnormal noise, etc. the first thing to do is to cut off the current and close the water tap.
- Make sure not to obstruct the air inlets of the appliance with towels or other objects.
- Beware of hot surfaces such as cup heaters, the unit heads and the hot water and steam outputs. Never install containers filled with liquid on the top of the appliance.

A.9 appliance cleaning and maintenance

- Refer to “A.3 *Personal protection equipment*” for suitable personal protection equipment.
- Put the appliance in safe conditions before starting any maintenance operation. Disconnect the appliance from the power supply and carefully unplug the power supply cable, if present.
- Depending on the model and type of electric connection, during maintenance operations, the cable and plug must be kept in a visible position by the operator carrying out the work.
- Do not touch the appliance with wet hands or feet or when barefoot.
- Do not remove the safety guards.
- Respect the requirements for the various routine and extraordinary maintenance operations. Non compliance with the instructions can create risks for personnel.
- Extraordinary maintenance, checking and overhaul operations must only be carried out by a specialised personnel or the Customer Care Service, provided with suitable personal protection equipment (safety shoes and gloves), tools and ancillary means.
- Do not clean the appliance with jets of water.

Repair and extraordinary maintenance

- Repair and extraordinary maintenance have to be carried out by specialised authorised personnel. The manufacturer declines any liability for any failure or damage caused by the intervention of an unauthorized technician by the Manufacturer and the original manufacturer warranty will be invalidated.
- The appliance should be descaled only by a specialised personnel.
- Do not forget to regenerate your water softener periodically.

A.10 Service

- Only original spare parts can ensure the safety standards of the appliance.

A.11 Disposal of packing

- Dispose of each packaging items respecting the current regulation in the country of installation.

A.12 Machine disposal

- Work on the electrical equipment must only be carried out by a specialised personnel, with the power supply disconnected.
- Dismantling operations must be carried out by specialised personnel.
- Make the appliance unusable by removing the power cable and any compartment closing devices, to prevent the possibility of someone becoming trapped inside.
- Refer to “A.3 *Personal protection equipment*” for suitable personal protection equipment.
- When scrapping the machine, the “CE” marking, this manual and other documents concerning the appliance must be destroyed.



IMPORTANT

Save these instructions carefully for further consultation by the various operators.

B GENERAL SAFETY RULES

B.1 Introduction

The machines are provided with electric and/or mechanical safety devices for protecting workers and the machine itself.

Therefore the user must not remove or tamper with such devices. The Manufacturer declines any liability for damage due to tampering or their non-use.

B.2 Mechanical safety characteristics, hazards

The machine does not have sharp edges or protruding parts. The guards for the moving and live parts are fixed to the cabinet with screws, to prevent accidental access.

B.3 Protection devices installed on the machine

The guards on the machine are (e.g. hopper, side panels, rear covers, etc.) fixed to the machine and/or frame with screws that can only be removed or opened with tools;

The machine has a main switch that acts as an emergency switch.



B.4 Main switch



In emergency case the machine can be entire deactivated by the main switch.

B.4.1 Appliance with 2 positions main switch

- 0 = appliance OFF
- 1 = appliance ON

B.5 Safety signs to be placed on the machine or near its area

Prohibition	Meaning
	do not oil, lubricate, repair and adjust moving parts
	do not remove the safety devices
	do not use water to extinguish fires (placed on electrical parts)

Danger	Meaning
	caution, hot surface
	danger of electrocution (shown on electrical parts with indication of voltage)

B.6 Instructions for use and maintenance

Risks mainly of a mechanical, thermal and electrical nature exist in the machine. Where possible the risks have been neutralised:

- directly, by means of adequate design solutions.
- indirectly by using guards, protection and safety devices.

Any anomalous situations are signalled on the control panel display.

During maintenance several risks remain, as these could not be eliminated, and must be neutralised by adopting specific measures and precautions.

Do not carry out any checking, cleaning, repair or maintenance operations on moving parts. Workers must be informed of this prohibition by means of clearly visible signs.

To guarantee machine efficiency and correct operation, periodical maintenance must be carried out according to the instructions given in this manual.

Make sure to periodically check correct operation of all the safety devices and the insulation of electrical cables, which must be replaced if damaged.

B.7 Reasonably foreseeable improper use

Improper use is any use different from that specified in this manual. During machine operation, other types of work or activities deemed improper and that in general can involve risks for the safety of operators and damage to the appliance are not allowed. Reasonably foreseeable improper use includes:

- lack of machine maintenance, cleaning and periodical checks;
- structural changes or modifications to the operating logic;
- tampering with the guards or safety devices;
- failure to use personal protection equipment by operators, specialised personnel and maintenance personnel;
- failure to use suitable accessories (e.g. use of unsuitable equipment or ladders);

- keeping combustible or flammable materials, or in any case materials not compatible with or pertinent to the work, near the machine;
- wrong machine installation;
- placing in the machine any objects or things not compatible with its use, or that can damage the machine, cause injury or pollute the environment;
- climbing on the machine;
- non-compliance with the requirements for correct machine use;
- other actions that give rise to risks not eliminable by the Manufacturer.



WARNING

The previously described actions are prohibited!

B.8 End of use

When the appliance is no longer to be used, make it unusable by removing the mains power supply wiring.

B.9 Residual risks

The machine has several risks that were not completely eliminated from a design standpoint or with the installation of adequate protection devices. Nevertheless, through this manual the Manufacturer has taken steps to inform operators of such risks, carefully indicating the personal protection equipment to be used by them. In order to reduce the risks, provide for sufficient spaces while installing the unit. To preserve these conditions, the areas around the machine must always be:

- kept free of obstacles (e.g. ladders, tools, containers, boxes, etc.);
- clean and dry;
- well lit.

For the Customer's complete information, the residual risks remaining on the machine are indicated below: such situations are deemed improper and therefore strictly forbidden.

Residual risk	Description of hazardous situation
Slipping or falling	The operator can slip due to water or dirt on the floor
Burns/abrasions (e.g. heating elements, cold pan, cooling circuit plates and pipes)	The operator deliberately or unintentionally touches some components inside the machine without using protective gloves.
Stab wounds	The operator deliberately or unintentionally touches some components with sharp edges during the machine cleaning without using protective gloves.
Burns	The operator deliberately or unintentionally touches some components inside the machine or dishes at the outfeed without using gloves or without allowing them to cool.
Shearing of upper limbs	The operator violently closes the front panels.
Electrocution	Contact with live parts during maintenance operations carried out with the electrical panel powered
Crushing or injury	The specialised personnel may not correctly fix the control panel when accessing the technical compartment. The panel could close suddenly.
Chemical	Contact with chemical substances (e.g. detergent, rinse aid, scale remover, etc.) without taking adequate safety precautions. Therefore always refer to the safety cards and labels on the products used.



IMPORTANT

In case of a significant anomaly (e.g. short circuits, wires coming out of the terminal block, motor breakdowns, worn electrical cable sheathing, etc.) the operator must immediately deactivate the machine.

C GENERAL INFORMATION

C.1 Introduction

Given below is some information regarding the intended use of this appliance, its testing, and a description of the symbols used (that identifies the type of warning), the definitions of terms used in the manual and useful information for the appliance user.

C.2 Definitions

Listed below are the definitions of the main terms used in the manual. It is advisable to read them carefully before use.

Operator	machine installation, adjustment, use, maintenance, cleaning, repair and transport personnel.
Manufacturer	UNIC SAS or any other service centre authorised by UNIC SAS.
Operator for normal machine use	an operator who has been informed and trained regarding the tasks and hazards involved in normal machine use.

Customer Care service or specialised personnel	an operator instructed/trained by the Manufacturer and who, based on his professional and specific training, experience and knowledge of the accident-prevention regulations, is able to appraise the operations to be carried out on the machine and recognise and prevent any risks. His professionalism covers the mechanical, electrotechnical and electronics fields etc.
Danger	source of possible injury or harm to health.
Hazardous situation	any situation where an operator is exposed to one or more hazards.
Risk	a combination of probabilities and risks of injury or harm to health in a hazardous situation.
Protection devices	safety measures consisting of the use of specific technical means (guards and safety devices) for protecting operators against risks.
Guard	an element of a machine used in a specific way to provide protection by means of a physical barrier.
Safety device	a device (other than a guard) that eliminates or reduces the risk; it can be used alone or in combination with a guard.

Customer	the person who purchased the machine and/or who manages and uses it (e. g. company, entrepreneur, firm).
Electrocution	an accidental discharge of electric current on a human body.



NOTE!
Refer to the data given on the machine's data plate for relations with the Manufacturer (e.g. when ordering spare parts, etc.).

C.3 Machine and manufacturer's identification data

An example of the marking or data plate on the machine is given below:

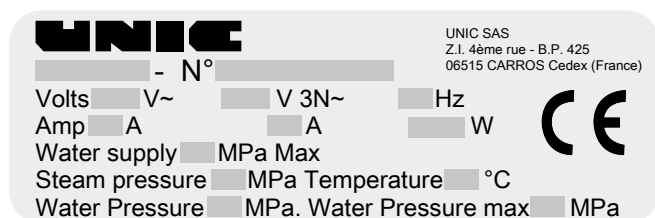

The data plate gives the product identification and technical data. The meaning of the various information given on it is listed below:

STELLA EPIC	commercial description
N°	serial number
Volts (V)	power supply voltage (monophase and/or triphase)
Hz	power supply frequency
Amp (A)	electrical intensity
W	max power input
Steam pressure (MPa)	boiler pressure
Temperature (°C)	boiler temperature
Water pressure (MPa)	water network pressure
Water pressure max (MPa)	max water network pressure
CE	CE marking
UNIC, Z.I. 4ème rue - B.P. 425, 06515 CARROS Cedex France	manufacturer

The data plate is located on the front of the equipment.

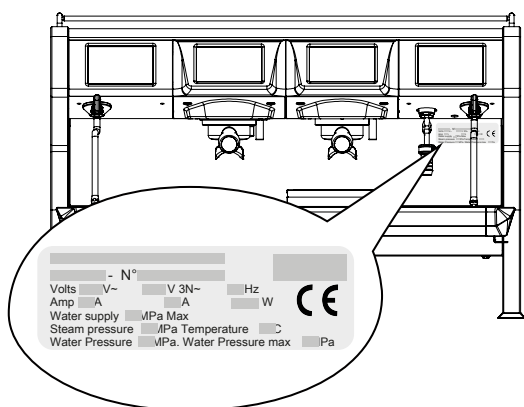

IMPORTANT

When installing the machine, make sure the electrical connection is carried out in compliance with that specified on the data plate.

C.4 Additional indications

The drawings and diagrams given in the manual are not in scale. They supplement the written information with an outline, but are not intended to be a detailed representation of the machine supplied.

The numerical values given on the appliance installation diagrams refer to measurements in millimeters and/or inches.

C.5 Responsibility

The Manufacturer declines any liability for damage and malfunctioning caused by:

- non-compliance with the instructions contained in this manual;
- repairs not carried out in a workmanlike fashion, and replacements with parts different from those specified in the spare parts catalogue (the fitting and use of non-original spare parts and accessories can negatively affect machine operation and invalidates the original manufacturer warranty);
- operations carried out by non-specialised personnel;
- unauthorized modifications or operations;
- missing, lack or inadequate maintenance;
- improper machine use;
- unforeseeable extraordinary events;
- use of the machine by uninformed and / or untrained personnel;
- non-application of the current provisions in the country of use, concerning safety, hygiene and health in the workplace.

The Manufacturer declines any liability for damage caused by arbitrary modifications and conversions carried out by the user or the Customer.

The employer, workplace manager or service technician are responsible for identifying and choosing adequate and suitable personal protection equipment to be worn by operators, in compliance with regulations in force in the country of use.

The Manufacturer declines any liability for inaccuracies contained in the manual, if due to printing or translation errors.

Any supplements to the installation, use and maintenance manual the Customer receives from the Manufacturer will form an integral part of the manual and therefore must be kept together with it.

C.6 Copyright

This manual is intended solely for consultation by the operator and can only be given to third parties with the permission of UNIC SAS.

C.7 Keeping the manual

The manual must be carefully kept for the entire life of the machine, until scrapping. The manual must stay with the machine in case of transfer, sale, hire, granting of use or leasing.

C.8 Recipients of the manual

This manual is intended for:

- the employer of machine users and the workplace manager
- operators for normal machine use
- specialised technicians - Customer Care service (see service manual).

D NORMAL USE

D.1 Characteristics of personnel enabled to operate on the machine

The Customer is responsible for ensuring that persons assigned to the various duties:

- read and understand the manual;
- receive adequate training and instruction for their duties in order to perform them safely;
- receive specific training for correct machine use.

D.2 Characteristics of personnel trained for normal machine use

The Customer must make sure the personnel for normal machine use are adequately trained and skilled in their duties, as well as ensuring their own safety and that of other persons.

The Customer must make sure his personnel have understood the instructions received and in particular those regarding work hygiene and safety in use of the machine.

D.3 Operator qualified for normal machine use

Must have at least:

- knowledge of the technology and specific experience in operating the machine;
- adequate general basic education and technical knowledge for reading and understanding the contents of the manual, including correct interpretation of the drawings, signs and pictograms;
- sufficient technical knowledge for safely performing his duties as specified in the manual;
- knowledge of the regulations on work hygiene and safety.

In case of a significant anomaly (e. g. short circuits, wires coming out of the terminal block, motor breakdowns, worn electrical cable sheathing, etc.) the operator for normal machine use must:

E TECHNICAL CHARACTERISTICS

E.1 Data table

ELECTRIC SUPPLY	POWER (Watt)	I, single phase (A)	I, three phases + neutral (A)	I, three phases (A)
230V single phase — 400V three phases + neutral	6700	30	10	-
240V single phase — 415 three phases + neutral	7700	32	11	-
200V single phase	5400	-	-	16
200V three phases + neutral	4600	24	-	-
208V – 240V single phase	6600	29	-	-
208V – 240V three phases + neutral	5578–7500	-	-	16–19
220V three phases + neutral	6300	-	-	17.5
230V three phases + neutral	6700	-	-	18
240V three phases + neutral	7500	-	-	19

Steam boiler	8.9 l
Each coffee boiler	1.65 l
Steam pressure	0.9 to 1 bar / 0.09 to 0.1 MPa
Pump pressure	9 bar / 0.9 MPa
High pressure valve	13 bar / 1.3 MPa
Dose of ground coffee	7 gr
Dose of water	5 to 7 cl
Infusion time	20 to 25 s

F OPERATING



NOTE!

When the machine has been installed and the hydraulic, electrical connections have been carried out by a qualified installer.



WARNING

Do not forget to open the water tap supplying the machine.

F.1 Switching on

Set the main switch on position 1.

When the power is switched on the machine performs an initialization cycle that checks all the components; the starting up time is approximately 45 seconds.

F.1.1 Filling the boilers

As soon as the power is switched on the boilers fill automatically.

Steam boiler

A safety function is provided in case the boiler is not filled in within 3 minutes: the filling solenoid valve and the pump switch off.

In all cases:

- Check the water supply to the machine

- Switch the machine off and on again: switch the main switch to 0 and then back to 1
- Filling starts again

Group boilers

A small amount of water should flow out of each group.

If not, the light bar above the faulty group flashes:

Check the water supply to the machine

Switch the machine off and on again: switch the main switch to 0 and then back to 1

Filling starts again

F.1.2 Switching on the heating

All the elements start heating automatically if filling is correct. When the machine reaches its operating temperature it is ready to work. The steam pressure and the group temperatures are displayed on the screen.

We recommend leaving the machine with the heating switched on all the time, and leaving the filter holders in position on the machine when they are not in use.

F.2 BTA description

F.2.1 Screen : thermal informations

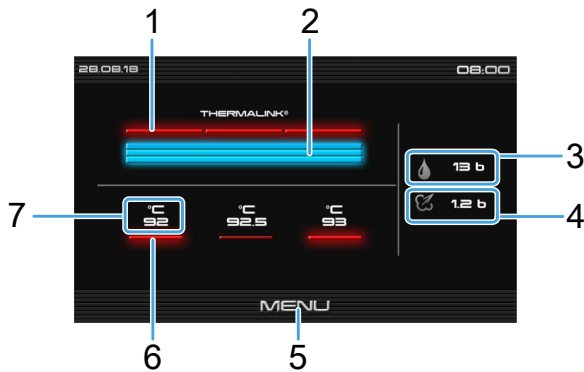

1. Steam boiler heating element 1 to 3
2. Steam boiler level
3. Machine's water network pressure
4. Steam pressure
5. Access to F.2.2 Screen : Quick access / code
6. Coffee boiler heating element
7. Coffee heater temperature

F.2.2 Screen : Quick access / code

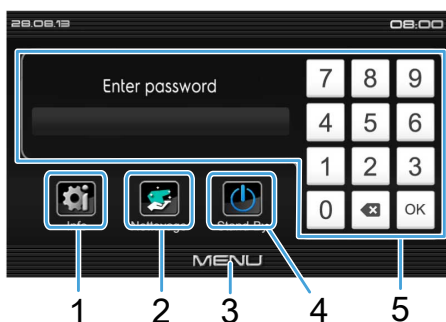

1. "Info": Click on this icon to access the page containing a summary of the information relating to the whole of the machine in real time

Direct controls for a Level 0 user

2. "Cleaning" icon: to access all available operations of cleaning and flushing
3. "Menu" icon: Comeback to the F.2.1 Screen : thermal informations
4. "Stand-By" icon: puts the machine in standby

5. "Password" To access the main menu, it is necessary to enter a Level 1 or Level 2 code. If the USB dongle is inserted: click on "OK" without entering a code

F.2.3 Various icons

	Icon to access the "quick access/code" screen
	Back to the main screen
	Back to the previous page
	Icon to copy a file and/or data
	Icon to indicate parameters (e.g.: steam settings)
	Icon to save data and/or settings
	Icon to confirm data and/or settings
	Icon to cancel data and/or settings
	Icon to access enabled error codes / alarms

F.3 Keyboards

F.3.1 Coffee keyboards

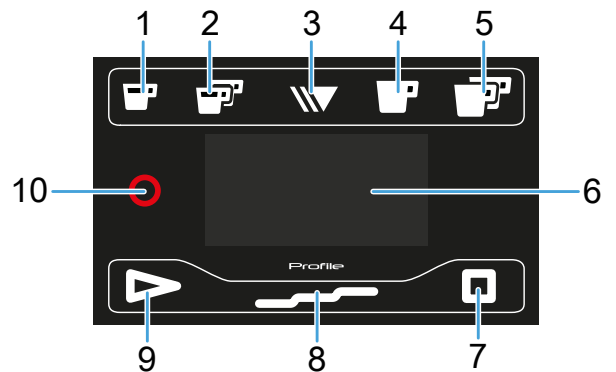

Fig. 1 4 doses box

1. 1 small cup icon
2. 2 small cups icon
3. Continu/stop icon
4. 1 large cup icon
5. 2 large cups icon
6. Display
7. Stop icon (free mode)
8. Pre-infusion icon (free mode)
9. Start icon (free mode)
10. Selection of an expert profile

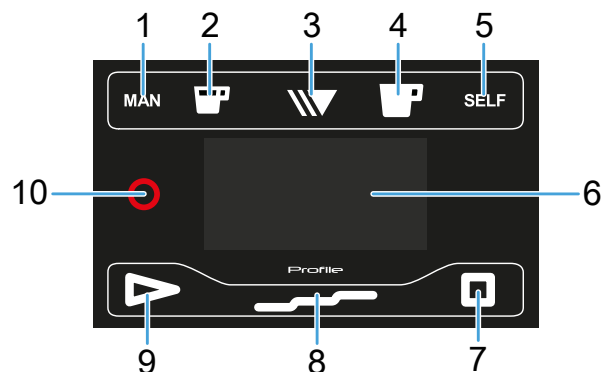

Fig. 2 Dosamat box

1. Manual mod icon (manual start of coffee cycle)
2. Small cup(s) icon, number of coffee according to the engaged filter holder (1 or 2 cups)
3. Continu/stop icon

4. Large cup(s) icon, number of coffee according to the engaged filter holder (1 or 2 cups)
5. Self mod icon (automatic start of coffee cycle)
6. Display
7. Stop icon (free mode)
8. Pre-infusion icon (free mode)
9. Start icon (free mode)
10. Selection of an expert profile

F.3.2 Service keyboards

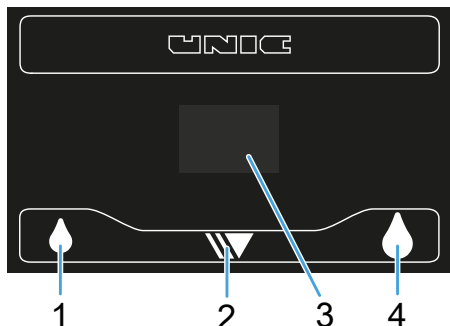

Fig. 3 Hot water box

1. Hot water icon (small dose)
2. Continu/stop icon
3. Display
4. Hot water icon (large dose)

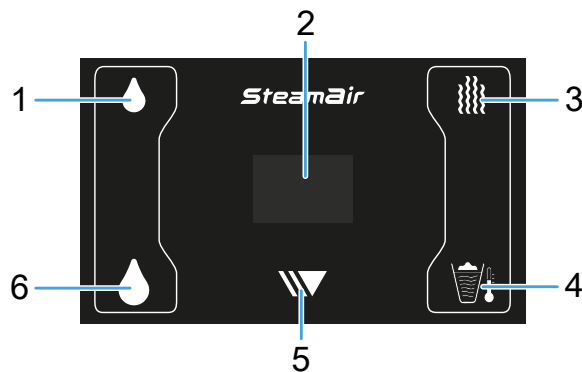

Fig. 4 Steamair box

1. Hot water icon (small dose)
2. Display
3. Steam icon
4. Steamair icon
5. Continu/stop icon
6. Hot water icon (large dose)

F.4 How to prepare a cappuccino

- Use a high narrow container half-full of cold milk (preferably skimmed).
- Keep the end-piece of the steam tube at the surface to obtain a fine foam.
- After each use, clean the steam tube with a wet rag and press a moment on the steam tap to eliminate the small amount of milk remaining in the tube.



NOTE!

Be careful to not boil the milk

G DAILY CLEANING

G.1 Cleaning groups

G.1.1 Before use or after several hours of inactivity

Drain

- for each unit and water outlet, 0.5 liter of water
- for each steam outlet, steam for 1 minute



IMPORTANT

Before preparing a drink

G.1.2 Rinse the decompression circuit

- Engage the cup onto the unit by tightening it
- Press a coffee key to pressurise the cup, and then stop the unit. Repeat the operation several times by emptying the water contained in the cup each time

G.1.3 Semi automatic cleaning

- Reference Puly Caff **92040**



NOTE!

for more information on cleaning products, refer to the manufacturer's safety data sheet.

- Reference plug **DO197**

Quick access to cleaning see F.2.2 Screen : Quick access / code

By pressing the "coffee cleaning" icon  you access the procedure. Follow it step by step on the machine BTA screen as indicated below.

Step 1

"Select the group(s) to clean and press confirm"



Step 2

Sequences of 8 seconds ON and 12 seconds OFF (EVX +PUMP), Numbers of sequences: 15

"Put the plug in the filter and add the detergent powder or tabs, reinsert the filter holder, then start the cycle press any key in the group"

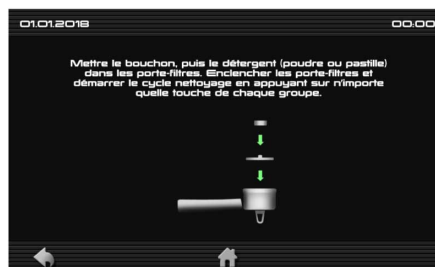

Step 3

The progress bar (blue) indicates the number of cycle finished



Step 4

“Remove the plug, reinsert the filter and press CONFIRM”

Description of the rinsing cycle: (EVX + PUMP) = ON for 45 seconds

When the rinsing cycle is ready to be started, press any key on the coffee keyboard to start the rinsing cycle and move the cup as shown on the display



Step 5

Follow the instructions shown on the BTA



Step 6

The BTA displays the message “groups cleaning completed”, confirm by press Ok button



G.2 External cleaning

Steam output tube:

After each use, clean the steam outlet with a damp cloth and release steam for a short time to eliminate the small residue of milk which has been able to remain in the tube. (Remove the tip of the steam pipe for easier cleaning).

Rinsing the decompression circuit:

- Engage the cup on the unit by tightening it.
- Press a coffee touch to pressurize the cup, and then stop the unit. Repeat the operation several times by emptying the water contained in the cup each time.

Rinsing the cup seal:

- Engage the filter—holder on the unit without tightening it.
- Press a coffee touch by tightening and loosening the filter—holder alternately, to create a leak at the level of the seal to clean it.

Basin grille

Remove the basin grille by lifting it up from the front. Clean the basin with a sponge.

Bodywork

Use a soft cloth and alcohol for the stainless steel parts, and a nonabrasive cleaning agent for the painted parts. Simply take care not to scratch the painted parts.

Keyboards cleaning



IMPORTANT

Never clean keyboard with liquid when the machine is in normal operation.

- Turn OFF the machine by main switch (position 0).
- Clean the keyboards and the front panel with a smooth towel and an adequate cleaning product.
- When the cleaning is done, turn ON the main switch (position 2).

H MAINTENANCE

H.1 Maintenance intervals

The inspection and maintenance intervals depend on the actual machine operating conditions and ambient conditions (presence of dust, damp, etc.), therefore precise time intervals cannot be given. In any case, careful and periodical machine maintenance is advisable in order to minimise service interruptions.

H.1.1 Preventive Maintenance

Preventive Maintenance reduces downtime and maximizes machines efficiency.

Customer Care Service can provide advice on the best maintenance plan to be purchased based on the intensity of use and the age of the equipment.

It is advisable to stipulate a preventive and scheduled maintenance contract with the Customer Care Service.

H.2 Softener

Test the water hardness of the network and refer to the technical documentation of the water softener used for optimum adjustment.

A softener must be changed every 1 year, even if it does not reach the end of its filtering capacity.

H.3 Machine disposal

At the end of the product's life cycle, make sure the equipment is not dispersed in the environment. The equipment must be

disposed of in compliance with current regulations in the country of use.

All metal parts are in stainless steel (AISI 304) and removable. Plastic parts are marked with the letters of the material.



The symbol  on the product indicates that this product should not be treated as domestic waste, but must be correctly

disposed of in order to prevent possible negative consequences for the environment and the human health.

Regarding the recycling of this product, please contact the sales agent or dealer of your product, your Customer Care service or the appropriate waste disposal service.

I STEAMAIR OPTION

I.1 Introduction

The Steamair option allows, particularly when making cappuccino, to foam the milk very easily and automatically: the supply of air mixed with steam brings milk to a programmed temperature (60° to 70°) and foams it.

The stop is done automatically when the temperature is reached which saves milk from boiling. By this way the milk qualities are preserved.

Once the air/steam adjustment is defined, the operation is as follows:

- Insert the Steamair outlet into the milk container.
- Push on the Steamair touch.
- Wait for it to stop automatically.

The Steamair box also controls a timed steam and hot water outlet.

I.2 Components

Setting foam

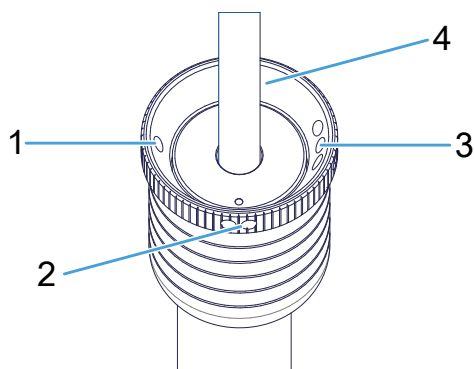

1. Level 1 Very fine foam
2. Level 2 Fine foam
3. Level 3 Medium foam
4. Steam only

I.3 Use

I.3.1 Automatic mode (To reach the programmed T°C)

One impulse on the touch makes the Steamair flow until the liquid reaches the preset temperature. You can stop it manually by pushing again on the touch.

I.3.2 Manual mode (Over the programmed T°C)

If after the stop in automatic mode (temperature reached) you wish to continue the heating, you have to press again the touch.

Then you go into manual mode and the outlet is again activated. To stop you will have to push again on the same touch. If you don't do it, it will be stopped automatically by one of the two safeties: after 180 seconds or when the liquid temperature reaches 96°C.

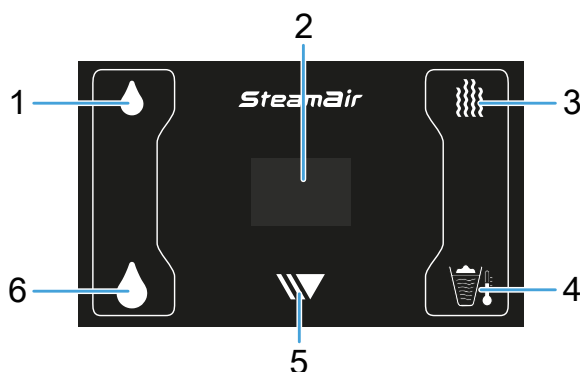

I.4 Programming







1. Hot water icon (small dose)
2. Display
3. Steam icon
4. Steamair icon
5. Continu/stop icon
6. Hot water icon (large dose)

The programming mode allows adjusting the steam and hot water time together with the Steamair level temperature adjustment.

To adjust the settings of the Steamair and the hot water control box, need the access to the setting of the machine by the BTA screen (for more information about level codes see "service manual")

By the BTA, press "Utilization" menu , then "Hot water and steam" menu 

When you are in the menu, select a line to make a adjustment by the icon , then use  or  icons to adjust the desired value, confirm the adjustment to save the settings 



NOTE!

The temperature adjustment can be done in a range of 50°C to 90°C. The default is 62°C.
 Steam time: 0 second to 99 seconds
 Small volume of water: 0 to 1,000 ml
 Large volume of water: 0 to 1,000 ml

CE

Z.I. 4e RUE - BP. 425
06515 CARROS CEDEX 1 - FRANCE
Tel. (33) 04 92 08 62 60
Fax: (33) 04 93 29 24 23
www.unic-sa.com