

# TANGO® ACE MT



---

EN User manual \*



\*Original instructions

TG9923- 2020.06

# Installation diagram

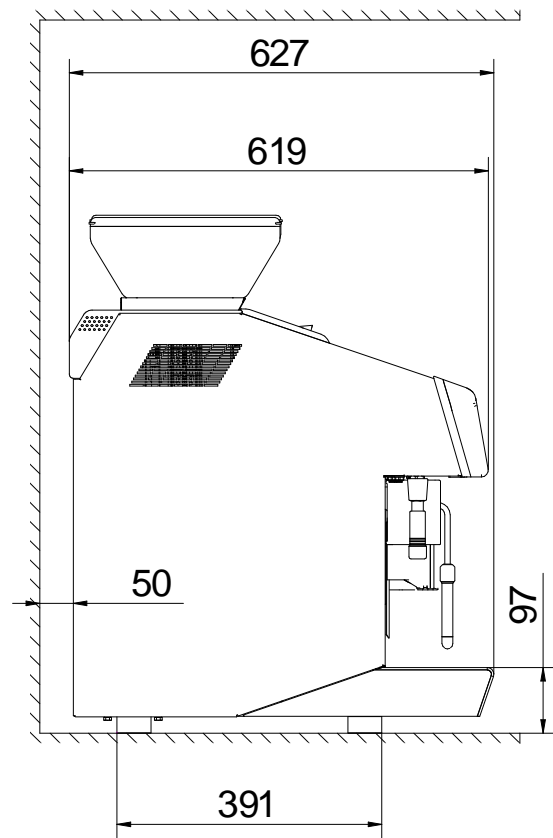
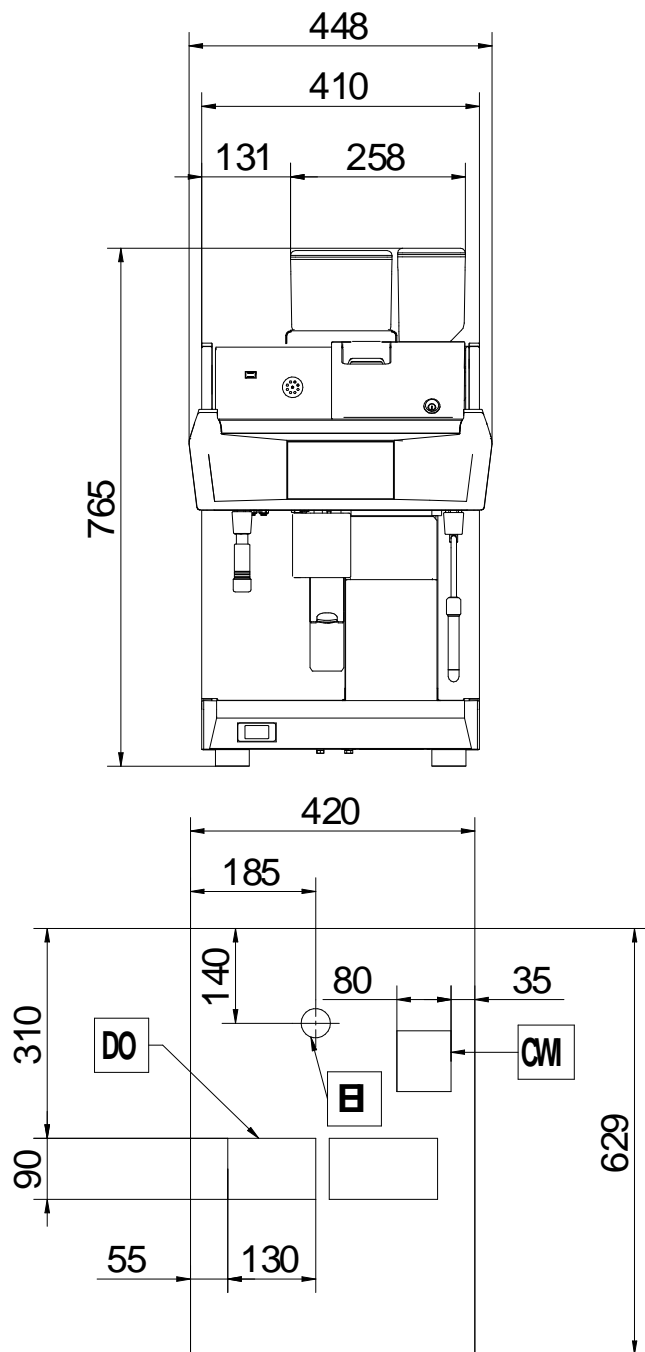

DO = Drain outlet  
EI = Electricity inlet

CWI = Cold water inlet G 3/8"

## Foreword



The installation, use and maintenance manual (hereinafter Manual) provides the user with information necessary for correct and safe use of the machine (or “appliance”).

The following must not be considered a long and exacting list of warnings, but rather a set of instructions suitable for improving machine performance in every respect and, above all, preventing injury to persons and animals and damage to property due to improper operating procedures.

All persons involved in machine transport, installation, commissioning, use and maintenance, repair and disassembly must consult and carefully read this manual before carrying out the various operations, in order to avoid wrong and improper actions that could compromise the machine's integrity or endanger people. Make sure to periodically inform the user regarding the safety regulations. It is also important to instruct and update personnel authorised to operate on the machine, regarding its use and maintenance.

The manual must be available to operators and carefully kept in the place where the machine is used, so that it is always at hand for consultation in case of doubts or whenever required.

If, after reading this manual, there are still doubts regarding machine use, do not hesitate to contact the Manufacturer or the authorised Service Centre to receive prompt and precise assistance for better operation and maximum efficiency of the machine. During all stages of machine use, always respect the current regulations on safety, work hygiene and environmental protection. It is the user's responsibility to make sure the machine is started and operated only in optimum conditions of safety for people, animals and property.



### IMPORTANT

- The manufacturer declines any liability for operations carried out on the appliance without respecting the instructions given in this manual.
- The manufacturer reserves the right to modify the appliances presented in this publication without notice.
- No part of this manual may be reproduced.
- This manual is available in digital format by:
  - contacting the dealer or reference customer care;
  - downloading the latest and up to date manual on the web site;
- The manual must always be kept in an easily accessed place near the machine. Machine operators and maintenance personnel must be able to easily find and consult it at any time.

# Contents

A	SAFETY INFORMATION	6
A.1	General information	6
A.2	General safety	6
A.3	Personal protection equipment	7
A.4	Transport, handling and storage	7
A.5	Installation and assembly	8
A.6	Water connection	8
A.7	Electrical connection	8
A.8	Use	9
A.9	appliance cleaning and maintenance	9
A.10	Service	9
A.11	Disposal of packing	9
A.12	Machine disposal	10
B	WARRANTY TERMS AND EXCLUSIONS	10
C	GENERAL SAFETY RULES	10
C.1	Introduction	10
C.2	Mechanical safety characteristics, hazards	10
C.3	Protection devices installed on the machine	10
C.4	Main switch	10
C.4.1	Appliance with 2 positions main switch	11
C.5	Safety signs to be placed on the machine or near its area	11
C.6	Instructions for use and maintenance	11
C.7	Reasonably foreseeable improper use	11
C.8	End of use	11
C.9	Residual risks	11
D	GENERAL INFORMATION	12
D.1	Introduction	12
D.2	Definitions	12
D.3	Machine and manufacturer's identification data	12
D.4	Additional indications	13
D.5	Responsibility	13
D.6	Copyright	13
D.7	Keeping the manual	13
D.8	Recipients of the manual	13
E	NORMAL USE	13
E.1	Characteristics of personnel enabled to operate on the machine	13
E.2	Characteristics of personnel trained for normal machine use	13
E.3	Operator qualified for normal machine use	13
F	TECHNICAL CHARACTERISTICS	14
F.1	Data table	14
G	DESCRIPTION PRODUCT	14
G.1	Overview	14
H	OPERATING	14
H.1	Switching on	14
H.2	Coffee	14
H.3	Screen (display)	15
H.4	Screen during an infusion	15
H.5	Screen : Quick access / code	15
I	DAILY CLEANING	15
I.1	Intro	15
I.2	Rinsing cycle	16
I.3	Daily cleaning cycles (duration ~10 minutes)	16
I.4	Cleaning soluble circuit	16
I.5	Cleaning milk	16
I.6	External cleaning	16
J	MAINTENANCE	16
J.1	Maintenance intervals	16
J.1.1	Preventive Maintenance	16
J.2	Preventive maintenance for coffee products	17
J.3	Softener	17
J.4	Machine disposal	17

---

## A SAFETY INFORMATION

---

### A.1 General information

To ensure safe use of the appliance and a proper understanding of the manual it is necessary to be familiar with the terms and typographical conventions used in the documentation. The following symbols are used in the manual to indicate and identify the various types of hazards:



#### **WARNING**

Danger for the health and safety of operators.



#### **WARNING**

Danger of electrocution - dangerous voltage.



#### **CAUTION**

Risk of damage to the machine or the product.



#### **IMPORTANT**

Important instructions or information on the product



Read the instructions before using the appliance







Clarifications and explanations

### A.2 General safety

- The machine must not be used by people (including children) with limited physical, sensory or mental abilities or without experience and knowledge of it, unless instructed in its use and supervised by those responsible for their safety.
  - Do not let children play with the machine.
  - Keep all packaging and detergents away from children.
  - Cleaning and user maintenance shall not be made by children without supervision.
- For suitable personal protection equipment, refer to chapter “A.3 *Personal protection equipment*”.
- Several illustrations in the manual show the machine, or parts of it, without guards or with guards removed. This is purely for explanatory purposes. Do not install the machine without the guards or with the protection devices deactivated.
- Do not remove, tamper with or make illegible the safety, danger and instruction signs and labels on the machine.
- Do not remove or tamper with the machine’s safety devices.
- Before carrying out any machine installation, always consult the installation manual, which gives the correct procedures and contains important information on safety.
- Unauthorized personnel must not enter the work area.
- Remove any flammable products or items from the work area.
- Machine positioning, installation and disassembly must be carried out by the specialised personnel in conformity with the current safety regulations, regarding the equipment used and the operating procedures.

### A.3 Personal protection equipment

Summary table of the Personal Protection Equipment (PPE) to be used during the various stages of the machine's service life.

Stage	Protective garments 	Safety footwear 	Gloves 	Glasses 	Safety helmet 
Transport	—	●	○	—	○
Handling	—	●	○	—	—
Unpacking	—	●	○	—	—
Installation	○	●	○ <sup>1</sup>	—	—
Normal use	—	○	—	—	—
Adjustments	—	○	○	—	—
Routine cleaning	—	—	○ <sup>2</sup>	—	—
Extraordinary cleaning	○	●	○	○	—
Maintenance	○	●	○	○	—
Dismantling	○	●	●	○	—
Scrapping	○	●	●	○	—
<b>Key:</b>					
●	<b>PPE REQUIRED</b>				
○	<b>PPE AVAILABLE OR TO BE USED IF NECESSARY</b>				
—	<b>PPE NOT REQUIRED</b>				

1. During these operations, gloves must be cut-resistant. Failure to use the personal protection equipment by operators, specialized personnel or users can involve exposure to damage to health (depending on the model).
2. During these operations, gloves must be suitable for contact with chemical substances used (refer to the safety data sheet of the substances used for information regarding the required PPE). Failure to use the personal protection equipment by operators, specialized personnel or users can involve exposure to chemical risk and cause possible damage to health (depending on the model).

### A.4 Transport, handling and storage

- Due to their size, the machines cannot be stacked on top of each other during transport, handling and storage; this eliminates any risks of loads tipping over due to stacking.
- Do not stand under suspended loads during loading or unloading operations. Unauthorized personnel must not enter the work area.
- The weight of the appliance alone is not sufficient to keep it steady.
- For machine lifting and anchoring, do not use movable or weak parts such as: casings, electrical raceways, pneumatic parts, etc.
- Do not push or pull the machine to move it, as it may tip over. Use proper tool to lift the machine.
- Machine transport, handling and storage personnel must be adequately instructed and trained regarding the use of lifting systems and personal protection equipment suitable for the type of operation carried out.

## **A.5 Installation and assembly**

- The installation must be carried out by a specialised personnel.
- Follow the installation instruction supplied with the appliance.
- Do not install a damaged appliance. Any missing or faulty parts must be replaced with original parts.
- Do not make any modifications to the parts supplied with the appliance.
- Disconnect the appliance from the power supply before carrying out any installation procedure. Connect the appliance to the power supply only at the end of the installation.
- The appliance is not suitable for installation outdoors and/or in places exposed to atmospheric agents (rain, direct sunlight, freeze, humid and dusty location, etc.).
- Make sure that the floor where you install the appliance is flat, stable, heat resistant and clean.
- Access to the service area is limited to persons with the necessary knowledge of safety and hygiene as well as practical experience of the device.
- Leave enough free space around the appliance to facilitate its use and to preform any maintenance operations.

## **A.6 Water connection**

- The plumbing connections must be carried out by a specialised personnel.
- The machine is to be connected to the water mains using the new supplied hose-sets. Do not use old hose sets.
- Always use a new set of joints if you remove and re-install the water inlet pipe to the machine.
- Before connection to new pipes, pipes not used for a long time, where repair work has been carried out or new devices fitted (water meters, etc.), let the water flow until it is clean and clear.
- The operating water pressure (minimum and maximum) must be between:
  - 1 bar [0.1 MPa] and 8 bar [0.8 MPa];
- Make sure that there are no visible water leaks during and after the first use of the machine.
- Install an approved dual check valve upstream according to the regulation of the installation country.

## **A.7 Electrical connection**

- Work on the electrical systems must only be carried out by a specialised personnel.
- Make sure that the electrical information on the rating plate agrees with the power supply.
- Make sure to install the appliance in accordance with the safety regulations and local laws of the country where used.
- If the power cable is damaged it must be replaced by the Customer Care Service or in any case by specialised personnel, in order to prevent any risk.
- The appliance must be correctly earthed. The manufacturer is not responsible for the consequences of an inadequate earthing system.
- To protect the power supply of the appliance against short circuits and/or overloads, install a thermal fuse or a suitable automatic thermal magnetic circuit breaker, ADS (Automatic Disconnection of Supply).
- To protect the power supply of the appliance against current leakages, install a high-sensitivity manual reset RCD (Residual Current Device), suitable for overvoltage category III.

For protection against indirect contacts, refer to point 6.3.3 of EN 60204-1 (IEC 60204-1) with the use of protection devices that ensure automatic cut-off of the supply in case of



isolation fault in the TN or TT systems or, for IT systems, the use of isolation controllers or differential current protection devices to activate automatic power disconnection (an isolation controller must be provided for indicating a possible first earth fault of a live part, unless a protection device is supplied for switching off the power in case of a such a fault. This device must activate an acoustic and/or visual signal which must continue for the entire duration of the fault). For example: in a TT system, a residual current device with cut-in current (e.g. 30 mA) coordinated with the earthing system of the building where the appliance is located must be installed ahead of the supply.

## **A.8 Use**

- The appliance must be used in room with an ambient temperature of 5°C to 35°C (41°F - 95°F).
- If it is stored at an ambient temperature below 5°C (41°F) the water circuit (boiler-piping) must be drained.
- In case of emergency (fire, surge, abnormal noise, etc. the first thing to do is to cut off the current and close the water tap.
- Make sure not to obstruct the air inlets of the appliance with towels or other objects.
- Beware of hot surfaces such as cup heaters, the unit heads and the hot water and steam outputs. Never install containers filled with liquid on the top of the appliance.

## **A.9 appliance cleaning and maintenance**

- Refer to “A.3 *Personal protection equipment*“ for suitable personal protection equipment.
- Put the appliance in safe conditions before starting any maintenance operation. Disconnect the appliance from the power supply and carefully unplug the power supply cable, if present.
- Depending on the model and type of electric connection, during maintenance operations, the cable and plug must be kept in a visible position by the operator carrying out the work.
- Do not touch the appliance with wet hands or feet or when barefoot.
- Do not remove the safety guards.
- Respect the requirements for the various routine and extraordinary maintenance operations. Non compliance with the instructions can create risks for personnel.
- Extraordinary maintenance, checking and overhaul operations must only be carried out by a specialised personnel or the Customer Care Service, provided with suitable personal protection equipment (safety shoes and gloves), tools and ancillary means.
- Do not clean the appliance with jets of water.

## **Repair and extraordinary maintenance**

- Repair and extraordinary maintenance have to be carried out by specialised authorised personnel. The manufacturer declines any liability for any failure or damage caused by the intervention of an unauthorized technician by the Manufacturer and the original manufacturer warranty will be invalidated.
- The appliance should be descaled only by a specialised personnel.
- Do not forget to regenerate your water softener periodically.

## **A.10 Service**

- Only original spare parts can ensure the safety standards of the appliance.

## **A.11 Disposal of packing**

- Dispose of each packaging items respecting the current regulation in the country of installation.

## A.12 Machine disposal

- Work on the electrical equipment must only be carried out by a specialised personnel, with the power supply disconnected.
- Dismantling operations must be carried out by specialised personnel.
- Make the appliance unusable by removing the power cable and any compartment closing devices, to prevent the possibility of someone becoming trapped inside.
- Refer to “A.3 *Personal protection equipment*” for suitable personal protection equipment.
- When scrapping the machine, the “CE” marking, this manual and other documents concerning the appliance must be destroyed.



### IMPORTANT

Save these instructions carefully for further consultation by the various operators.

---

## B WARRANTY TERMS AND EXCLUSIONS

---

If the purchase of this product includes warranty coverage, warranty is provided in line with local regulations and subject to the product being installed and used for the purposes as designed, and as described within the appropriate equipment documentation.

Warranty will be applicable where the customer has used only genuine spare parts and has performed maintenance in accordance with Electrolux Professional user and maintenance documentation made available in paper or electronic format.

Electrolux Professional strongly recommends using Electrolux Professional approved cleaning, rinse and descaling agents to obtain optimal results and maintain product efficiency over time.

The Electrolux Professional warranty does not cover:

- service trips cost to deliver and pick up the product;
- installation;
- training on how to use/operate;
- replacement (and/or supply) of wear and tear parts unless resulting from defects in materials or workmanship reported within one (1) week from the failure;
- correction of external wiring;
- correction of unauthorized repairs as well as any damages, failures and inefficiencies caused by and/or resulting from:
  - insufficient and/or abnormal capacity of the electrical systems (current/voltage/frequency, including spikes and/or outages);
  - inadequate or interrupted water supply, steam, air, gas (including impurities and/or other that does not comply with the technical requirements for each machine);
  - plumbing parts, components or consumable cleaning products that are not approved by the manufacturer;

- customer’s negligence, misuse, abuse and/or non-compliance with the use and care instructions detailed within the appropriate equipment documentation;
- improper or poor: installation, repair, maintenance (including tampering, modifications and repairs carried out by third parties not authorized) and modification of safety systems;
- Use of non-original components (e. g.: consumables, wear and tear, or spare parts);
- environment conditions provoking thermal (e. g. overheating/freezing) or chemical (e. g. corrosion/oxidation) stress;
- foreign objects placed in- or connected to- the product;
- accidents or force majeure;
- transportation and handling, including scratches, dents, chips, and/or other damage to the finish of the product, unless such damage results from defects in materials or workmanship and is reported within one (1) week of delivery unless otherwise agreed;
- product with original serial numbers that have been removed, altered or cannot be readily determined;
- replacement of light bulbs, filters or any consumable parts;
- any accessories and software not approved or specified by Electrolux Professional.

Warranty does not include scheduled maintenance activities (including the parts required for it) or the supply of cleaning agents unless specifically covered within any local agreement, subject to local terms and conditions.

Check on Electrolux Professional website the list of authorized customer care.

---

## C GENERAL SAFETY RULES

---

### C.1 Introduction

The machines are provided with electric and/or mechanical safety devices for protecting workers and the machine itself.

Therefore the user must not remove or tamper with such devices. The Manufacturer declines any liability for damage due to tampering or their non-use.

### C.2 Mechanical safety characteristics, hazards

The machine does not have sharp edges or protruding parts. The guards for the moving and live parts are fixed to the cabinet with screws, to prevent accidental access.

### C.3 Protection devices installed on the machine

The guards on the machine are (e.g. hopper, side panels, rear covers, etc.) fixed to the machine and/or frame with screws that can only be removed or opened with tools;

The machine has a main switch that acts as an emergency switch.



### C.4 Main switch



In emergency case the machine can be entire deactivated by the main switch.

#### C.4.1 Appliance with 2 positions main switch

- 0 = appliance OFF
- 1 = appliance ON

#### C.5 Safety signs to be placed on the machine or near its area

Prohibition	Meaning
	do not oil, lubricate, repair and adjust moving parts
	do not remove the safety devices
	do not use water to extinguish fires (placed on electrical parts)

Danger	Meaning
	caution, hot surface
	danger of electrocution (shown on electrical parts with indication of voltage)

#### C.6 Instructions for use and maintenance

Risks mainly of a mechanical, thermal and electrical nature exist in the machine. Where possible the risks have been neutralised:

- directly, by means of adequate design solutions.
- indirectly by using guards, protection and safety devices.

Any anomalous situations are signalled on the control panel display.

During maintenance several risks remain, as these could not be eliminated, and must be neutralised by adopting specific measures and precautions.

Do not carry out any checking, cleaning, repair or maintenance operations on moving parts. Workers must be informed of this prohibition by means of clearly visible signs.

To guarantee machine efficiency and correct operation, periodical maintenance must be carried out according to the instructions given in this manual.

Make sure to periodically check correct operation of all the safety devices and the insulation of electrical cables, which must be replaced if damaged.

#### C.7 Reasonably foreseeable improper use

Improper use is any use different from that specified in this manual. During machine operation, other types of work or activities deemed improper and that in general can involve risks for the safety of operators and damage to the appliance are not allowed. Reasonably foreseeable improper use includes:

- lack of machine maintenance, cleaning and periodical checks;
- structural changes or modifications to the operating logic;
- tampering with the guards or safety devices;
- failure to use personal protection equipment by operators, specialised personnel and maintenance personnel;
- failure to use suitable accessories (e.g. use of unsuitable equipment or ladders);

- keeping combustible or flammable materials, or in any case materials not compatible with or pertinent to the work, near the machine;
- wrong machine installation;
- placing in the machine any objects or things not compatible with its use, or that can damage the machine, cause injury or pollute the environment;
- climbing on the machine;
- non-compliance with the requirements for correct machine use;
- other actions that give rise to risks not eliminable by the Manufacturer.



#### WARNING

The previously described actions are prohibited!

#### C.8 End of use

When the appliance is no longer to be used, make it unusable by removing the mains power supply wiring.

#### C.9 Residual risks

The machine has several risks that were not completely eliminated from a design standpoint or with the installation of adequate protection devices. Nevertheless, through this manual the Manufacturer has taken steps to inform operators of such risks, carefully indicating the personal protection equipment to be used by them. In order to reduce the risks, provide for sufficient spaces while installing the unit. To preserve these conditions, the areas around the machine must always be:

- kept free of obstacles (e.g. ladders, tools, containers, boxes, etc.);
- clean and dry;
- well lit.

For the Customer's complete information, the residual risks remaining on the machine are indicated below: such situations are deemed improper and therefore strictly forbidden.

Residual risk	Description of hazardous situation
Slipping or falling	The operator can slip due to water or dirt on the floor
Burns/abrasions (e.g. heating elements, cold pan, cooling circuit plates and pipes)	The operator deliberately or unintentionally touches some components inside the machine without using protective gloves.
Stab wounds	The operator deliberately or unintentionally touches some components with sharp edges during the machine cleaning without using protective gloves.
Burns	The operator deliberately or unintentionally touches some components inside the machine or dishes at the outfeed without using gloves or without allowing them to cool.
Shearing of upper limbs	The operator violently closes the front panels.
Electrocution	Contact with live parts during maintenance operations carried out with the electrical panel powered

Residual risk	Description of hazardous situation
Crushing or injury	The specialised personnel may not correctly fix the control panel when accessing the technical compartment. The panel could close suddenly.
Chemical	Contact with chemical substances (e.g. detergent, rinse aid, scale remover, etc.) without taking adequate safety precautions. Therefore always refer to the safety cards and labels on the products used.



### IMPORTANT

In case of a significant anomaly (e.g. short circuits, wires coming out of the terminal block, motor breakdowns, worn electrical cable sheathing, etc.) the operator must immediately deactivate the machine.

## D GENERAL INFORMATION

### D.1 Introduction

Given below is some information regarding the intended use of this appliance, its testing, and a description of the symbols used (that identifies the type of warning), the definitions of terms used in the manual and useful information for the appliance user.

### D.2 Definitions

Listed below are the definitions of the main terms used in the manual. It is advisable to read them carefully before use.

Operator	machine installation, adjustment, use, maintenance, cleaning, repair and transport personnel.
Manufacturer	Electrolux Professional SpA or any other service centre authorised by Electrolux Professional SpA.
Operator for normal machine use	an operator who has been informed and trained regarding the tasks and hazards involved in normal machine use.
Customer Care service or specialised personnel	an operator instructed/trained by the Manufacturer and who, based on his professional and specific training, experience and knowledge of the accident-prevention regulations, is able to appraise the operations to be carried out on the machine and recognise and prevent any risks. His professionalism covers the mechanical, electrotechnical and electronics fields etc.
Danger	source of possible injury or harm to health.
Hazardous situation	any situation where an operator is exposed to one or more hazards.
Risk	a combination of probabilities and risks of injury or harm to health in a hazardous situation.
Protection devices	safety measures consisting of the use of specific technical means (guards and safety devices) for protecting operators against risks.
Guard	an element of a machine used in a specific way to provide protection by means of a physical barrier.
Safety device	a device (other than a guard) that eliminates or reduces the risk; it can be used alone or in combination with a guard.
Customer	the person who purchased the machine and/or who manages and uses it (e.g. company, entrepreneur, firm).
Electrocution	an accidental discharge of electric current on a human body.

### D.3 Machine and manufacturer's identification data

An example of the marking or data plate on the machine is given below:

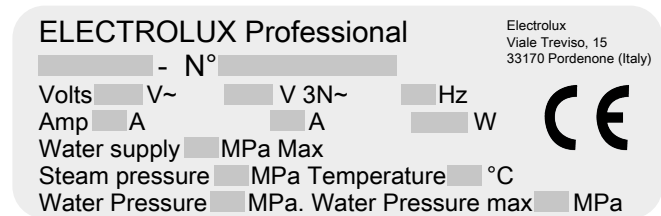

The data plate gives the product identification and technical data. The meaning of the various information given on it is listed below:

TANGO	commercial description
N°	serial number
Volts (V)	power supply voltage (monophase and/or triphase)
Hz	power supply frequency
Amp (A)	electrical intensity
W	max power input
Steam pressure (MPa)	boiler pressure
Temperature (°C)	boiler temperature
Water pressure (MPa)	water network pressure
Water pressure max (MPa)	max water network pressure
CE	CE marking
Electrolux Professional SpA Viale Treviso 15 33170 Pordenone Italy	manufacturer

The data plate is located behind the waste drawer of the equipment.

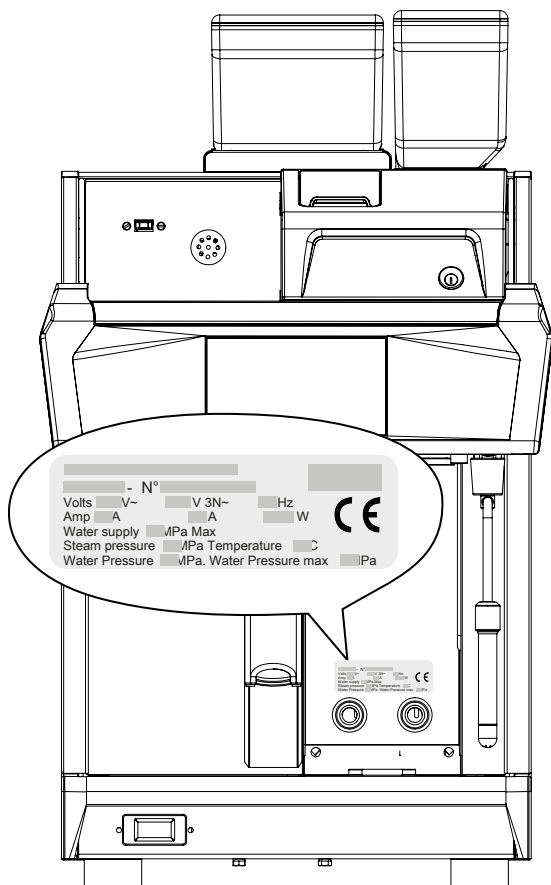

#### IMPORTANT

When installing the machine, make sure the electrical connection is carried out in compliance with that specified on the data plate.



#### NOTE!

Refer to the data given on the machine's data plate for relations with the Manufacturer (e.g. when ordering spare parts, etc.).

### D.4 Additional indications

The drawings and diagrams given in the manual are not in scale. They supplement the written information with an outline, but are not intended to be a detailed representation of the machine supplied.

The numerical values given on the appliance installation diagrams refer to measurements in millimeters and/or inches.

## E NORMAL USE

### E.1 Characteristics of personnel enabled to operate on the machine

The Customer is responsible for ensuring that persons assigned to the various duties:

- read and understand the manual;
- receive adequate training and instruction for their duties in order to perform them safely;
- receive specific training for correct machine use.

### E.2 Characteristics of personnel trained for normal machine use

The Customer must make sure the personnel for normal machine use are adequately trained and skilled in their duties, as well as ensuring their own safety and that of other persons.

### D.5 Responsibility

**The Manufacturer declines any liability for damage and malfunctioning caused by:**

- non-compliance with the instructions contained in this manual;
- repairs not carried out in a workmanlike fashion, and replacements with parts different from those specified in the spare parts catalogue (the fitting and use of non-original spare parts and accessories can negatively affect machine operation and invalidates the original manufacturer warranty);
- operations carried out by non-specialised personnel;
- unauthorized modifications or operations;
- missing, lack or inadequate maintenance;
- improper machine use;
- unforeseeable extraordinary events;
- use of the machine by uninformed and / or untrained personnel;
- non-application of the current provisions in the country of use, concerning safety, hygiene and health in the workplace.

The Manufacturer declines any liability for damage caused by arbitrary modifications and conversions carried out by the user or the Customer.

The employer, workplace manager or service technician are responsible for identifying and choosing adequate and suitable personal protection equipment to be worn by operators, in compliance with regulations in force in the country of use.

The Manufacturer declines any liability for inaccuracies contained in the manual, if due to printing or translation errors.

Any supplements to the installation, use and maintenance manual the Customer receives from the Manufacturer will form an integral part of the manual and therefore must be kept together with it.

### D.6 Copyright

This manual is intended solely for consultation by the operator and can only be given to third parties with the permission of ELECTROLUX.

### D.7 Keeping the manual

The manual must be carefully kept for the entire life of the machine, until scrapping. The manual must stay with the machine in case of transfer, sale, hire, granting of use or leasing.

### D.8 Recipients of the manual

**This manual is intended for:**

- the employer of machine users and the workplace manager
- operators for normal machine use
- specialised technicians - Customer Care service (see service manual).

The Customer must make sure his personnel have understood the instructions received and in particular those regarding work hygiene and safety in use of the machine.

### E.3 Operator qualified for normal machine use

Must have at least:

- knowledge of the technology and specific experience in operating the machine;
- adequate general basic education and technical knowledge for reading and understanding the contents of the manual, including correct interpretation of the drawings, signs and pictograms;
- sufficient technical knowledge for safely performing his duties as specified in the manual;

- knowledge of the regulations on work hygiene and safety.

In case of a significant anomaly (e.g. short circuits, wires coming out of the terminal block, motor breakdowns, worn

electrical cable sheathing, etc.) the operator for normal machine use must:

## F TECHNICAL CHARACTERISTICS

### F.1 Data table

Dimensions	
Width	453 mm [17.8 "]
Height	770 mm [30.3 "]
Depth	629 mm [24.8 "]
Weight	100kg [220.4 Lbs]

Capacities	
Steam / coffee boiler	6.5 Liters
Coffee waste drawer	100 coffees
Numbers of cups / hour	200

## G DESCRIPTION PRODUCT

### G.1 Overview



1. Main switch
2. Door
3. Telescopic hot water outlet
4. Touch screen (display)
5. Cup heater
6. Ground coffee trap
7. Coffee bin
8. Powder bin
9. Steam outlet
10. Coffee grounds drawer
11. Coffee outlet



### WARNING

Do not forget to open the water tap supplying the machine.

## H OPERATING



### NOTE!

When the machine has been installed and the hydraulic, electrical connections have been carried out by a qualified installer.

grounds drawer is in place, and they must not be interrupted, for instance by removing the drawer.

When the buzzer stops, and the home page is displayed, the appliance is ready to make coffee.

### H.1 Switching on

Set the main switch on position 1. The touch screen illuminates and appears thus:



The boilers fill automatically, and then the heating starts; the temperature changes (coffee and group) are displayed on the screen.

When the temperatures are reached, the machine automatically performs the initialization phases.

These initialization phases are very important for the proper functioning of the machine. They are only possible if the coffee

### H.2 Coffee

#### Use of coffee group

On the group, you have the possibility of obtaining up to 48 different (per group), and programmable, products.

- Place the cup under the coffee outlet after possibly adjusted its height as a according to the type of cups.
- Choose the icon and check that the colour of the bar under the icon corresponds to the mill that you want to use; then press the icon.
- During the cycle, the icon of the product chosen remains displayed in close-up.

#### Coffee grounds drawer

Depending on the number of cups made and the capacity programmed, a message on the display prompts you to empty your coffee grounds drawer. You can empty it or check its level at any time. To do this, simply:

- Open the door and remove the coffee grounds drawer.
- Empty the drawer or check its content.
- Refit the spool in place and close the door.



- Confirm by pressing the “YES” key for 3 seconds if you have emptied the drawer, and the “NO” key if you have not emptied it.



#### IMPORTANT

If you make a mistake when confirming, it is preferable to remove the drawer again, and empty it if necessary. Then replace the drawer and confirm by “YES” for 3 seconds.

### H.3 Screen (display)



1. Scrolls the product keyboards.
2. Hot water icons: Serve to trigger output of hot water, small volume: small Icon / Large volume: large Icon.
3. Selection icons: To launch the desired product. The colour bar under each of the icons indicates the mill that will be used during the cycle.
  - PURPLE: left mill
  - ORANGE: central mill
  - GREEN: right mill
4. To access favourite products directly. (Page 1).
5. To access the list of main functions.
6. Icon to access the error codes / alarms activated.
7. Icon to indicate the remaining time of the compulsory cleaning of the machine (before blocking).
8. Steam icon: Initiate the production of steam, Small quantity: Small Icon / Large quantity: Large Icon.
9. Allows to make coffee with ground coffee introduced manually by the trap (for 10 seconds).

### H.4 Screen during an infusion



#### 1. “STOP function“:

The Stop icon stops a cycle in progress instantly, regardless of what it is. If the “cycle repetition” function is enabled, press twice to stop.

#### 2. “Cycle repetition“:

The  $\oplus$  and  $\ominus$  buttons that appear on the screen during the cycle, serve to pre-set the number of cycles that will run consecutively continuously.

- Pressing the  $\oplus$  icon as many times as necessary until the expected number is displayed between the  $\oplus$  and  $\ominus$ .
- To decrease the number displayed, press the  $\ominus$  icon as many times as necessary to reach the desired value.
- The cycles start automatically after selection, and run until the number chosen is reached.

### H.5 Screen : Quick access / code

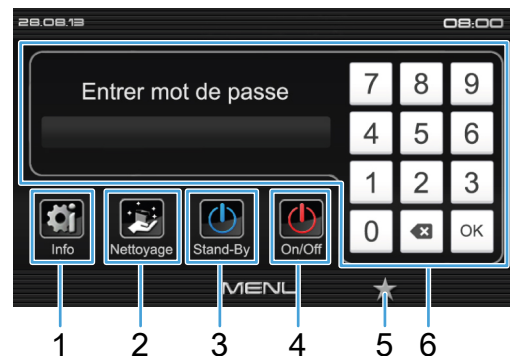

1. “Info“: Click on this icon to access the page containing a summary of the information relating to the whole of the machine in real time.

#### Direct controls for a Level 0 user

2. “Cleaning“ icon: to access all available operations of cleaning and flushing.
3. “Stand-By“ icon: puts the machine in standby.
4. “On-Off“ icon: stops or starts the machine if the main switch is in position 1.
5. “Star“ icon: To access favourite products directly. (Page 1).
6. “Password“ To access the main menu, it is necessary to enter a Level 1 or Level 2 code. If the USB dongle is inserted: click on “OK” without entering a code.

## I DAILY CLEANING

### I.1 Intro



#### IMPORTANT

On a fully automatic coffee machine, it is very important to perform the cleaning sequences described below at least once a day to ensure a good level of hygiene, quality of service and reliability of your machine.

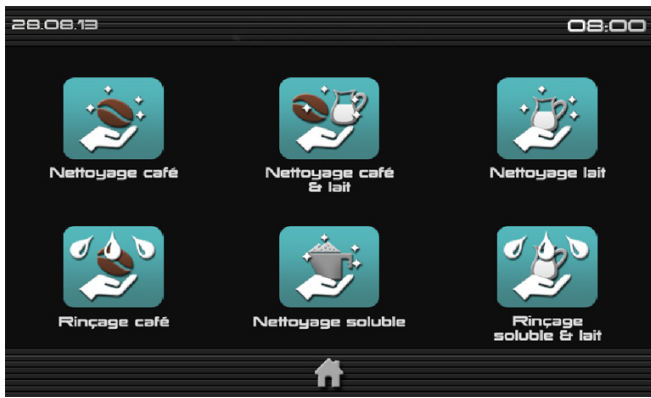

## I.2 Rinsing cycle

### Manual flush cycles

These flush cycles circulate water all through the corresponding circuit. They can be repeated several times or interrupted. Rinsing time ~30 seconds.

### Automatic flushes

In the course of the day, the machine triggers automatic internal flushes during periods of inactivity.

## I.3 Daily cleaning cycles (duration ~10 minutes)



### IMPORTANT

IT IS ESSENTIAL TO PERFORM THESE CYCLES EVERYDAY AFTER THE SERVICE. The machine requires cleaning every **26 hours maximum**.



### Daily cleaning of the coffee group

- Press this icon to start coffee group cleaning.
- Follow the instructions
- The display shows you how to proceed through the different stages.
- For safety reasons, this cycle must in no circumstances be interrupted; this is to guarantee that the detergent product is perfectly flushed out.



### CAUTION

REMEMBER TO INSERT **1 DETERGENT PELLETT**. Use only detergent pellet for coffee machines: Part number 92060. These pellets have been developed and validated for the Tango; they are compatible with the level of filtration of the group. The use of any other product could lead to blockages in the washing circuit and result in the group being poorly flushed at the end of the cycle.

1. For more information on cleaning products, refer to the manufacturer's safety data sheet.

## I.4 Cleaning soluble circuit



- Internal circuit included and all external components of soluble circuit.
- Press this icon to start cleaning.
- Follow the instructions.

## I.5 Cleaning milk



- Press this icon to start milk cleaning.
- Follow the instructions.
- When the cleaning is complete put fresh milk in the milk tank.



Detergent part number 92027.

Jug part number 54212.

## I.6 External cleaning



### NOTE!

We recommend dismantling the coffee and milk delivery nozzles daily at the end of the service for careful cleaning

### Cleaning the coffee outlet nozzle

1. Position the coffee nozzle at the bottom
2. Pull the nozzle towards you
3. Clean the nozzle under a tap or directly in a glass washer
4. Refit the nozzle on the machine

### Cleaning Cappuccino nozzle

1. Position the coffee nozzle at the bottom
2. Pull the nozzle towards you
3. Remove the complete cappuccino system by turning the unit to the right and pulling it down
4. Remove each item separately to clean it individually, silicone suction tube included
5. Reassemble

### Steam nozzle

After every use, clean the steam tube with a damp cloth and press the steam key briefly to drive out the small amount of liquid (e.g.: milk) remaining in the tube. Remove the tip of the steam nozzle to clean it more easily.

### Basin grille

Remove the basin grille by lifting it up from the front. Clean the basin with a sponge.

### Bodywork

Use a soft cloth and alcohol for the stainless steel parts, and a nonabrasive cleaning agent for the painted parts. The coffee grounds drawer is entirely stainless steel; it can therefore be cleaned without problem in water. Simply take care not to scratch the painted parts.

## J MAINTENANCE

### J.1 Maintenance intervals

The inspection and maintenance intervals depend on the actual machine operating conditions and ambient conditions (presence of dust, damp, etc.), therefore precise time intervals cannot be given. In any case, careful and periodical machine maintenance is advisable in order to minimise service interruptions.

#### J.1.1 Preventive Maintenance

Preventive Maintenance reduces downtime and maximizes machines efficiency.

Customer Care Service can provide advice on the best maintenance plan to be purchased based on the intensity of use and the age of the equipment.



It is advisable to stipulate a preventive and scheduled maintenance contract with the Customer Care Service.

## J.2 Preventive maintenance for coffee products

Indication of Different consumption for coffee products.

Consumption Coffee/week in kg	Consumption Coffee/ year in kg	Number of cups/weeks (130 CUPS/KG)	Annual Meter Statement
Inferior to 15	Inferior to 800	Inferior to 2000	Inferior to 100000
15 to 20	800 to 1000	2000 to 2600	100000 to 135000
Superior to 20 to 25	Superior to 1000 to 1300	Superior to 2600 to 3200	Superior to 135000 to 170000
Superior to 25	Superior to 1300	Superior to 3200	Superior to 170000

Service interval Cycles	Maintenance level		
	Low level <sup>1</sup>	Medium level <sup>2</sup>	High level <sup>3</sup>
60 000	✓		
120 000	✓	✓	
180 000	✓		
240 000	✓	✓	✓
300 000	✓		
360 000	✓	✓	
420 000	✓		
480 000	✓	✓	✓
540 000	✓		
600 000	✓	✓	
660 000	✓		
720 000	✓	✓	✓
780 000	✓		
840 000	✓	✓	
900 000	✓		

1. Checking of piston filter(s) and coffee solenoid valve(s)
2. Change the high part of the piston(s) "lip gasket" and lubrication / change gasket and bearing turntable / replace grinding blades set
3. Complete group change

## J.3 Softener

Test the water hardness of the network and refer to the technical documentation of the water softener used for optimum adjustment.

A softener must be changed every 1 year, even if it does not reach the end of its filtering capacity.

## J.4 Machine disposal

At the end of the product's life cycle, make sure the equipment is not dispersed in the environment. The equipment must be disposed of in compliance with current regulations in the country of use.

All metal parts are in stainless steel (AISI 304) and removable. Plastic parts are marked with the letters of the material.



The symbol  on the product indicates that this product should not be treated as domestic waste, but must be correctly disposed of in order to prevent possible negative consequences for the environment and the human health.

Regarding the recycling of this product, please contact the sales agent or dealer of your product, your Customer Care service or the appropriate waste disposal service.





CE

Electrolux Professional SPA  
Viale Treviso 15  
33170 Pordenone  
[www.electroluxprofessional.com](http://www.electroluxprofessional.com)