



**Vegetable Slicer**  
**Prep4You vegetable slicer,1 speed,**  
**2 discs included,1000w, nema 5-15p**

ITEM # \_\_\_\_\_  
 MODEL # \_\_\_\_\_  
 NAME # \_\_\_\_\_  
 SIS # \_\_\_\_\_  
 AIA # \_\_\_\_\_



**602250 (DVGSUS)**

Vegetable Slicer, single speed (1800 rpm) with 2 discs included (slicer 5/32", grater 5/64"), NEMA 5-15P plug

**Short Form Specification**

Item No. \_\_\_\_\_

Vegetable slicer ensures consistent cutting results thanks to the design patented lever-pusher. Constructed in a sturdy plastic material. 1.25 liters transparent half-moon hopper. Vegetables can be fed directly into the half moon hopper, a pusher presses the vegetables against the cutting discs ensuring an even cut in minimal time. 2 small hoppers for precise cuts on long vegetables dia. 55mm or 25mm. Ideal for grating, slicing/wavy slice, julienne and dicing. 2 discs included: slicer 4mm (5/32") and grater 2mm (5/64"). A safety micro switch stops the blade when the feed hopper is opened. No-volt release system prevents accidental start of the appliance. All parts in contact with food are removable and Dishwasher safe. Single speed 1800 rpm with on/pulse/off function for simple operations. NEMA 5-15P plug

**Main Features**

- Vegetable slicer unit has slicing, grating, shredding (julienne) as well as dicing and french fries capabilities.
- Continuous feed model.
- Equipped with half moon hopper (1.32 qt capacity) and 2 small round feed chutes: 1" (25mm) and or 2 11/64" (55mm), for precise slicing of long shaped vegetables.
- Uniform cuts and maximized load capacity, thanks to the design patented lever-pusher.
- Large output chute for efficient ejection. Fits up to 7 3/4" high standard kitchen containers (like GN) under the output chute.
- Pulse function for quick and precise slicing and grating.
- Vegetable slicer blade stops when lever pusher is lifted for operator safety.
- Optional discs available of various sizes for slicing, grating and shredding.
- All parts in contact with food are removable without the use of tools, completely dismountable and dishwasher safe.
- Easy to clean and watertight control panel with on/off button and pulse function.
- Productivity up to 100 settings per service.
- ErgoCert 4-star certification for ergonomic design and ease of use.
- Model includes 2 discs: 5/64" (2mm) grater, 5/32" (4mm) slicer.

**Construction**

- compact design, easy to move and store.
- IPX5 (IP55) flat panel touch-control, watertight panel.
- Main switch ON/OFF on the back of the appliance.
- Asynchronous industrial motor with no brushes for high reliability and quiet functioning, stainless steel motor shaft.
- Food safety assured thanks to BPA-free materials and compliance with NSF standards.
- Product safety in accordance with international and UL standards.
- 1 speed: 1800 rpm.
- Motor power: 1 HP / 750 Watt.

**Included Accessories**

- 1 of Stainless steel grating disc 2 mm (dia. 175mm) PNC 650198
- 1 of Ejector for Vegetable Slicer PNC 650232
- 1 of Stainless steel slicing disc 4 mm (dia. 175mm) PNC 650237

**Optional Accessories**

APPROVAL: \_\_\_\_\_

**Prep4You vegetable slicer,1 speed, 2 discs included,1000w, nema 5-15p**  
**Vegetable Slicer**



## Vegetable Slicer Prep4You vegetable slicer,1 speed, 2 discs included,1000w, nema 5-15p

- Cleaning tool for TRS, TRK & TR210 3/16-5/16-3/8 in (5-8-10 mm) dicing grids PNC 650110
- 3 DISCS SET TRK1 (5/64" SLICER, 3/16" SLICER, 1/8" GRATER) PNC 650196
- 6 DISCS SET (5/64" SLICING, 3/16" SLICING, 1/8" GRATING, 9/32" GRATING, 3/8" SLICER, 3/8"x3/8" GRID) PNC 650197
- Stainless steel grating disc 2 mm (dia. 175mm) PNC 650198
- Stainless steel grating disc 3 mm (dia. 175mm) PNC 650199
- STAINLESS STEEL GRATING DISC 5/32" (4 MM) PNC 650205
- Stainless steel grating disc 7 mm (dia. 175mm) PNC 650207
- PARMESAN DISC PNC 650208
- Stainless steel shredding disc 2 mm (dia. 175mm) PNC 650209
- Stainless steel shredding disc 4 mm (dia. 175mm) PNC 650210
- STAINLESS STEEL JULIENNE DISC 5/16" (8 MM) FOR FRENCH FRIES PNC 650211
- Stainless steel slicing disc 1 mm (dia. 175mm) PNC 650213
- Stainless steel slicing disc 2 mm (dia. 175mm) PNC 650214
- STAINLESS STEEL SLICING DISC 1/8" (3 MM) PNC 650215
- Stainless steel slicing disc 5 mm (dia. 175mm) PNC 650216
- Stainless steel slicing disc 6 mm (dia. 175mm) PNC 650217
- STAINLESS STEEL WAVY SLICING DISC 1/8" (3 MM) PNC 650218
- STAINLESS STEEL WAVY SLICING DISC 3/16" (5 MM) PNC 650219
- Aluminum slicing disc 8 mm (dia. 175mm) PNC 650220
- Aluminum slicing disc 10 mm (dia. 175mm) PNC 650221
- Dicing grid 8x8 (dia 175mm) PNC 650222
- Dicing grid 10x10 (dia 175mm) PNC 650223
- DICING KIT 5/16" - ALUMINUM SLICER 5/16", GRID 5/16"x5/16" (8X8MM) PNC 650224
- DICING KIT 3/8" - ALUMINUM SLICER 3/8", GRID 3/8"x3/8" (10X10 MM) PNC 650225
- Ejector for Vegetable Slicer PNC 650232
- Stainless steel slicing disc 4 mm (dia. 175mm) PNC 650237
- Support for 1 disc, diam. 175mm and 205mm PNC 653632
- Set of 3 discs, diam. 175 mm (1mm slicer, 4mm julienne/shredder, 7mm grater) PNC 653867
- Set of 5 discs, diam. 175 mm (1mm and 6mm slicer, 7mm grater, 2mm julienne/shredder, 4mm julienne/shredder) PNC 653868





# Vegetable Slicer

## Prep4You vegetable slicer, 1 speed, 2 discs included, 1000w, nema 5-15p

Front

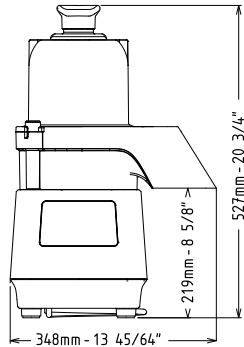

Side

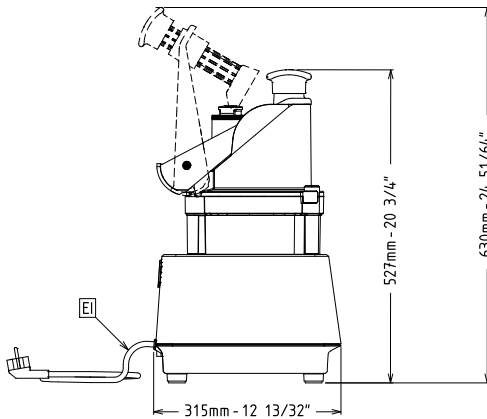

EI = Electrical connection

Top

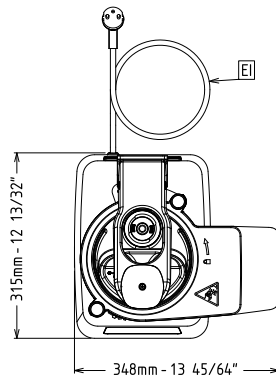

Electric

**Supply voltage:**

**602250 (DVGSUS)** 115 V/1N ph/60 Hz

**Electrical power, max:** 1 kW

**Total Watts:** 1 kW

**Capacity:**

**Performance (up to):** 150 kg/hour

**Performance (up to):** 330,6 lbs/cycle

**Key Information:**

**External dimensions, Width:**

13 11/16" (348 mm)

**External dimensions, Depth:**

12 3/8" (315 mm)

**External dimensions, Height:**

20 3/4" (527 mm)

**Shipping width:**

16 9/16" (420 mm)



Vegetable Slicer  
Prep4You vegetable slicer, 1 speed, 2 discs included, 1000w, nema 5-15p  
The company reserves the right to make modifications to the products without prior notice. All information correct at time of printing.

2024.11.28