



Vegetable Slicer TR260 Vegetable Slicer, lever hopper, 2 speed, 2000w

ITEM # _____
 MODEL # _____
 NAME # _____
 SIS # _____
 AIA # _____



602255 (DTR260-29)

TR260 VEGETABLE
 SLICER+LEVER HOPPER,
 2 SPEED,
 2000W/2-2/3HP/208-240-
 V/3PH/60HZ

Short Form Specification

Item No. _____

Vegetable Slicer high capacity, continuous feed design, large single feed hopper, handle pusher, standard ejector, stainless steel construction, 2-2/3 HP, 208-240v/60/3, 8.3 amps, 2 kW, NEMA L15-20P (No discs included).

Main Features

- Continuous feed model.
- Optional stainless steel mobile stand accessory.
- Magnetic safety system and motor brake. Prevents machine from running when lever swings away or is open.
- Available upon request:-Automatic hopper (dia=280 mm), lever-operated hopper, long vegetable hopper (3 tubes) and cabbage hopper.
- Complete selection of blades and dicing grids available (diameter 300 mm).
- Vegetable slicer unit has slicing, grating, shredding (julienne) as well as dicing and french fries capabilities.
- "No volt release" safety device.
- Available as option a long vegetable accessory to fit in the lever operated hopper converting it into a long vegetable hopper (3 cylindrical hoppers: 50, 59,5, 70 mm diameter)
- Suitable for up to 600 meals for table service and up to 2000 meals for catering service.

Construction

- 2 speed: 330-660 rpm.
- Power: 2000 or 2200 watts.
- Capacity depending on the hopper:-lever hopper: 700kg/h-automatic hopper: 2500kg/h

Included Accessories

- 1 of Feed tray to be combined with PNC 650036 cabbage hopper and long vegetable hopper
- 1 of Lever operated hopper for TR260 PNC 653510

Optional Accessories

- Feed tray to be combined with cabbage hopper and long vegetable hopper PNC 650036
- S/S GRATING DISC FOR PARMESAN PNC 650148
- S/S GRATING DISC FOR KNOEDELN PNC 650149
- S/S GRATING DISC 2 MM PNC 650150
- S/S GRATING DISC 3 MM PNC 650151
- S/S GRATING DISC 4 MM PNC 650152
- S/S GRATING DISC 7 MM PNC 650153
- S/S GRATING DISC 9MM PNC 650154
- S/S CABBAGE GRATING DISC 7 MM FOR HOPPER PNC 650157
- Stainless steel mobile stand. PNC 653017
- Dicing grid 3/8". PNC 653051
- Dicing grid 5/8" PNC 653052
- Dicing grid 3/4" PNC 653053

APPROVAL: _____

TR260 Vegetable Slicer, lever hopper, 2 speed, 2000w
 Vegetable Slicer



Vegetable Slicer TR260 Vegetable Slicer, lever hopper, 2 speed, 2000w

- Dicing grid 15/16" PNC 653054
- Dicing grid 1 1/4" PNC 653055
- Slicing blade 1/16". PNC 653172
- Slicing blade 1/8". PNC 653173
- Slicing blade 1/32". PNC 653188
- Slicing blade 3/16". PNC 653189
- Slicing blade 1/4". PNC 653190
- Slicing blade 5/16". PNC 653191
- Slicing blade 3/8". PNC 653192
- Slicing blade 5/8". PNC 653193
- French fry / julienne blade 1/16". PNC 653195
- French fry / julienne blade 1/8". PNC 653196
- French fry / julienne blade 5/32". PNC 653197
- French fry / julienne blade 1/4". PNC 653198
- French fry / julienne blade 5/16". PNC 653199
- French fry / julienne blade 3/8". PNC 653200
- Stainless steel blade rack. PNC 653212
- Crinkle cut blade 1/16". PNC 653217
- Crinkle cut blade 1/8". PNC 653218
- Crinkle cut blade 1/4". PNC 653219
- Dicing grid 1/2" PNC 653301
- Lever operated hopper for TR260 PNC 653510





Vegetable Slicer

TR260 Vegetable Slicer, lever hopper, 2 speed, 2000w

Front

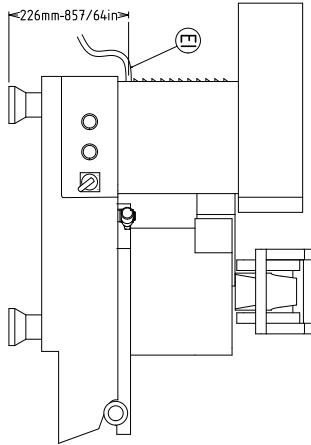

Side

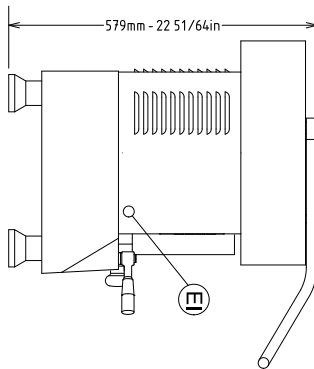

EI = Electrical connection

Top

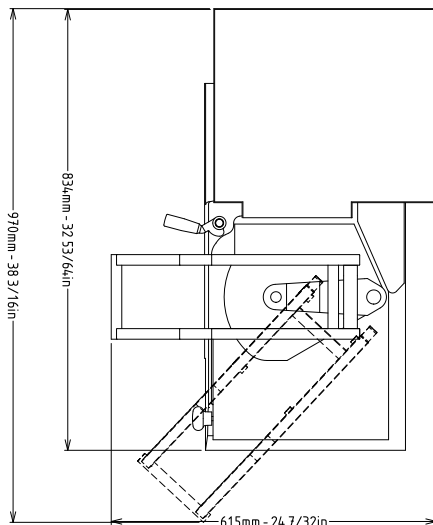

Electric

Supply voltage:	208-240 V/3 ph/60 Hz
Total Watts:	2 kW
Plug type:	USA NEMA L15-20P

Key Information:

External dimensions, Width:	29 1/2" (750 mm)
External dimensions, Depth:	14 15/16" (380 mm)
External dimensions, Height:	18 1/8" (460 mm)
Shipping width:	19 11/16" (500 mm)
Shipping depth:	31 1/2" (800 mm)
Shipping height:	47 1/4" (1200 mm)
Shipping weight:	146 lbs (66 kg)



Vegetable Slicer
TR260 Vegetable Slicer, lever hopper, 2 speed, 2000w

The company reserves the right to make modifications to the products without prior notice. All information correct at time of printing.

2025.04.19