

Handling System Sorting Table Right to Left, 1000x800mm

ITEM # _____

MODEL # _____

NAME # _____

SIS # _____

AIA # _____

865334 (BHST1008R)

 Sorting table, Right>Left,
 1000x800 mm

Short Form Specification

Item No. _____

Constructed in 304 AISI stainless steel. N. 4 square 40x40mm square legs on height-adjustable feet. Underframe on three sides.

1-tier overshelf for baskets. N. 1 waste scraping hole with rubber ring. Attachment to infill tops or slide conveyors on the left side. Basket direction: from right to left.

Construction

- All surfaces smooth with polished finish.
- Receiving tabletop with raised side edges all-round, reduces the possibility of crockery being pushed off the table.
- Constructed in AISI 304 stainless steel with square 40x40mm legs.
- Sorting table provided with an over-shelf for dishwashing racks which can be inclined at either the dishwashing or receiving side.
- One or two waste holes with a rubber scraping ring tabletop.

Sustainability

- Optional extras: plain tray slider, cutlery chute or additional scraping hole.

Optional Accessories

- Dish scraper PNC 855297
- Shelf for Plates and baskets, 1000 mm PNC 865375
- Tray slide for sorting table, 1000 mm PNC 865379
- Cutlery chute to install on tray slide PNC 865383
- Floor fastening kit for 2 square legs PNC 865386
- Removable bridge table, 800 mm PNC 865418
- Removable bridge table with hole, 800 mm PNC 865419

APPROVAL: _____



Electrolux
PROFESSIONAL

Handling System Sorting Table Right to Left, 1000x800mm

Key Information:

External dimensions, Width: 1000 mm
865334 (BHST1008R)
External dimensions, Depth: 800 mm
External dimensions, Height: 1551 mm
Net weight: 8 kg

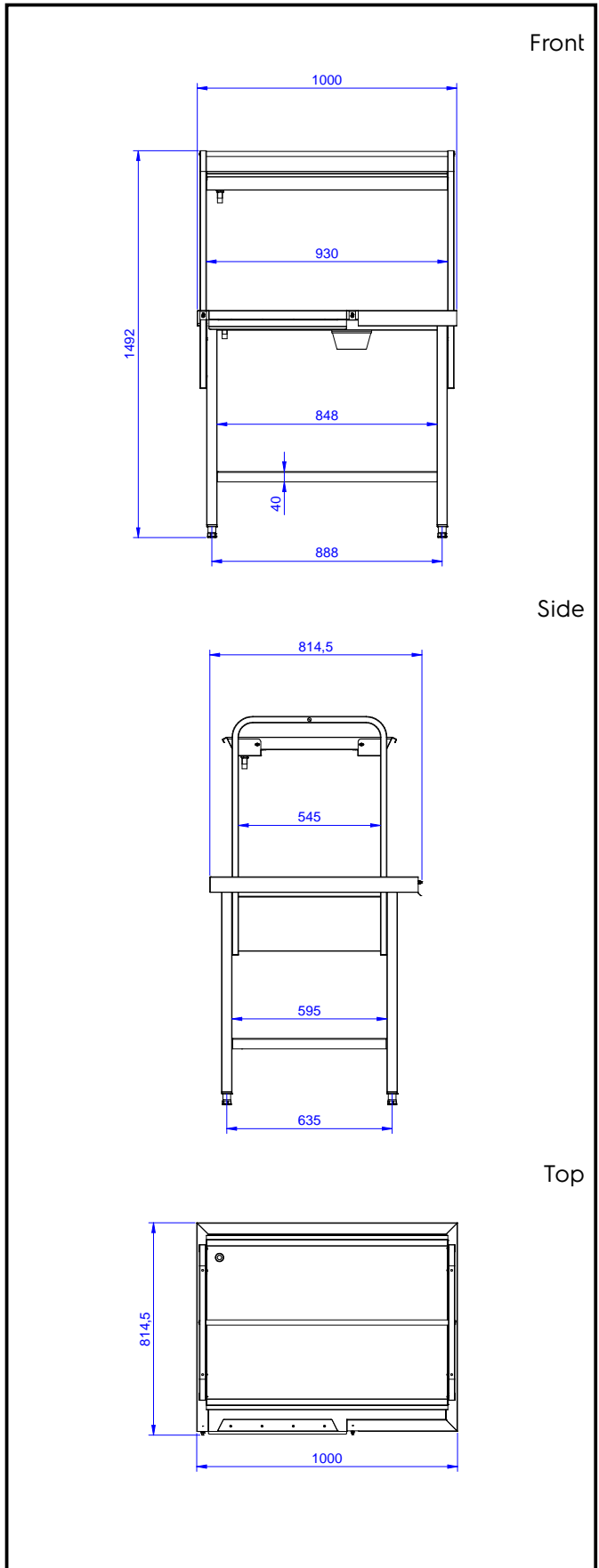

Handling System
Sorting Table Right to Left, 1000x800mm

The company reserves the right to make modifications to the products without prior notice. All information correct at time of printing.

2024.09.24

