

4JUICES



560253 - 562720 - 562743

General Features

4JUICES is a professional equipment ideal to dispense chilled beverages prepared starting from concentrated juice.

4JUICES dispenses up to 4 different drinks and it is equipped with 4 containers each with a capacity of 4 litres of concentrated juice. It is possible upon request to have a prearrangement for bag-in-box connection and the auto-supply water kit.

The machine guarantees high performance levels. The cooling system with pressure-sealed insulated tank assures that the juice temperature doesn't change even in case of continuous dispenses. The water level in the tank is automatically restored after every dispense.

The juice/water dilution ratio is adjustable.

4JUICES has 2 dispensing modes: based on pre-set doses (glass-full or jug-full, maximum height 25 cm) or continuous service with push control.

The unit is provided with 3/4 inch connection pipe for water inlet.

4JUICES

Specifications

- Ideal to dispense chilled beverages prepared from concentrated juice. (only for 560253)
- It dispenses up to 4 different drinks. (only for 560253)
- It is possible to use glasses or jugs of 25,5 cm maximum height. (only for 560253)
- The juice/water dilution ratio is adjustable. (only for 560253)
- 2 dispensing modes: based on pre-set doses or continuous service with push control. (only for 560253)

Construction

- It is equipped with 4x4- litres containers of concentrated juice. (only for 560253)
- The unit is provided with 3/4 inch connection pipe for water inlet. (only for 560253)
- The water level in the tank is automatically restored after every dispense. (only for 560253)
- It is possible upon request to have a prearrangement for bag-in-box connection and the auto-supply water kit. (only for 560253)
- The backlit frontal panel is designed for customized graphics. (only for 560253)

4JUICES

Electric

Supply voltage:	220-230 V / 1 ph / 50/60 Hz
Electrical power max.:	
560253 (4JUICES)	0.3 kW
562720 (4JUICES)	0.35 kW
562743 (4JUICES)	0.35 kW
Current consumption:	
560253 (4JUICES)	1.7 Amps
562720 (4JUICES)	2.3 Amps
562743 (4JUICES)	2.3 Amps
Plug type:	CE-SCHUKO

Key Information:

Dimensions, Width:	475 mm
Dimensions, Depth:	600 mm
Dimensions, Height:	825 mm
Net weight:	50 kg
Cooling system:	AIR
Flavors:	4
Container capacity per flavor:	4 lt

Refrigeration Data

Refrigerant gas:	R134a
------------------	-------

Certifications



The company reserves the right to make modifications to the products without prior notice. All information correct at time of printing.

2026.04.21

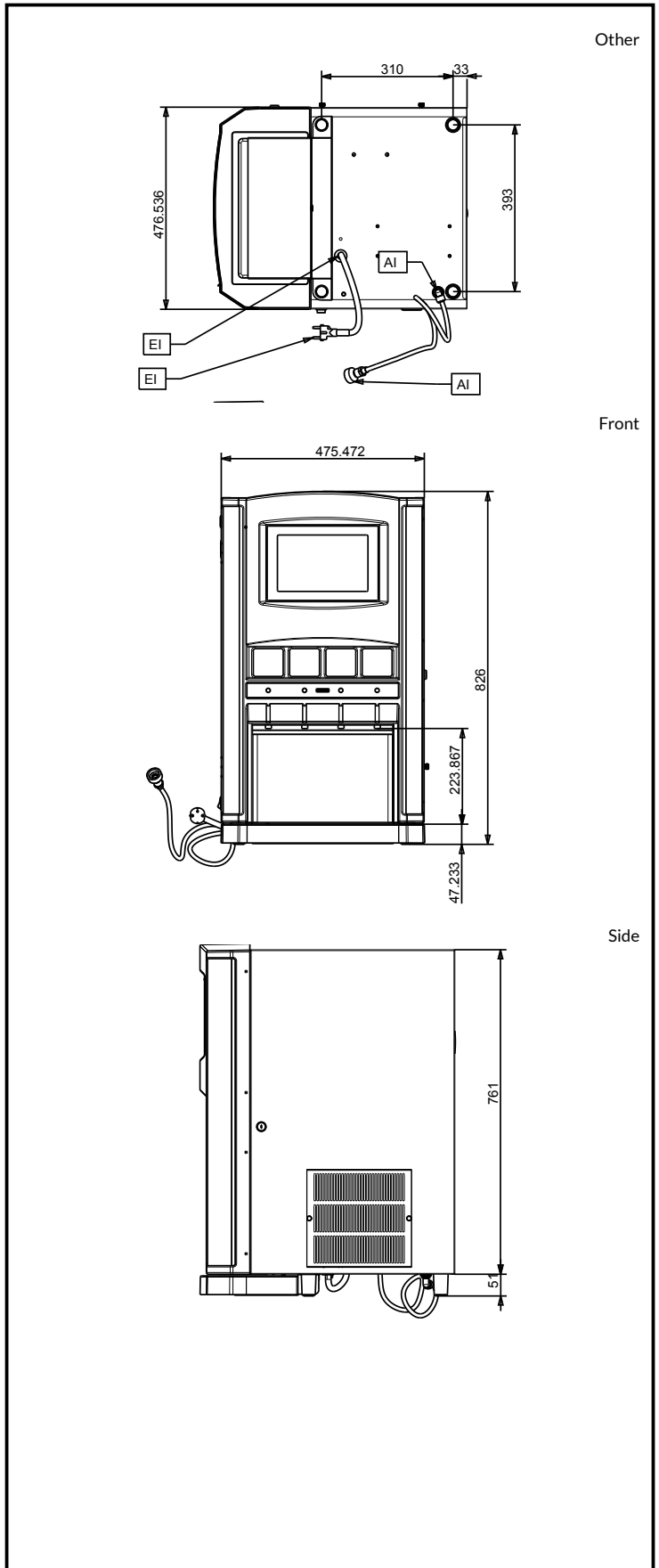

SPM

www.spm.drink-systems.com
infospm@electroluxprofessional.com