

## STELLA EPIC 2, Premium, Striped stainless steel



### Ref602964 (EPIC2PREMIUMUL)

Multi-boilers espresso machine Striped stainless steel sides panels, 2 groups, 2 x 1.65 liter boilers for coffee, 8.9 liter hot water & steam boiler, Central control LCD Touch screen, 2 independent control boxes with 4 programmable dosing program, Thermalink Network, programmable pre-infusion time per group, Steamglide, programmable steam cool touch & water, automatic cleaning cycle, Easylock brew group, stainless steel body

### General Features

Multi-boiler espresso machine featuring a design inspired from the 50's and a technology fully deep-seated in the digital era, it offers high-end features geared towards the barista keen to explore coffees aromas with high precision. The Stella Epic machine guarantees exceptional brewing with its Thermalink Network® technology and a PID controller for a consistent brewing temperature. Its expert mode gives full control of the settings and allows saving up to 5 recordable extraction profiles per group to enhance high quality coffees extraction.

The Stella Epic is the ideal commercial espresso machine for coffee shops and businesses offering specialty coffee beverages that call for precise adjustments and maximum steam capacity. The Stella Epic 2 groups is recommended for businesses consuming an average of 10-12 Kg of coffee per week.

# STELLA EPIC 2, Premium, Striped stainless steel

## Main Features

- LCD touchscreen to take control of the settings, in expert mode it allows saving up to 5 recordable extraction profiles per group to enhance high quality coffees extraction.
- 2 independent control boxes with 4 programmable dosing selection, start/stop, pre and post infusion profiling manual control, infusion pressure curve and shot time display
- Cool touch steam outlets to control steam without the risk of burns, easier to clean after each use
- Easily height-adjustable drip tray to adapt the working area
- 8.9 liter hot water & steam boiler
- 2 x 1.65 liter boilers for coffee
- LED lights on group head
- Programmable water and steam.
- Automatic cleaning cycle.
- Electronic pre infusion.
- Double paneled cup warmer with large capacity.
- USB interface for update.
- Striped Stainless steel esthetic color body
- Manual Steamglide lever.

## Construction

- PID (proportional-integral-derivative) Temperature control: a precise controller algorithm system that gives consistency and accuracy to brewing temperature management system.
- Easylock portafilter.
- RS-232 protocol for computer/cashier interface.
- Built-in cup warmer.

## Sustainability

- Multi-boiler traditional espresso machine with Thermalink Network® technology that intelligently controls and optimizes the distribution of heat, that guarantees consistent brewing temperature and efficiency in terms of energy requirements.

# STELLA EPIC 2, Premium, Striped stainless steel

## Electric

Supply voltage:

602964  
(EPIC2PREMIUMUL) 220 V/1 ph/60 Hz

Electrical power, max: 6.13 kW

Plug type:

## Water:

Cold water temperature  
(min/max): 5 / 60 °C

## Key Information:

External dimensions,  
Width: 31 1/8" (790 mm)

External dimensions,  
Depth: 26 7/8" (682 mm)

External dimensions,  
Height: 20 3/16" (513 mm)

External dimensions,  
Weight: 198 lbs (90 kg)

Net weight: 198 lbs (90 kg)

Shipping width: (1100 mm)

Shipping depth: (750 mm)

Shipping height: (840 mm)

Shipping weight: lbs (107 kg)

Shipping volume: 0.8 m<sup>3</sup>

## Certifications



The company reserves the right to make modifications to the products without prior notice. All information correct at time of printing.

2024.09.01

Part of  Electrolux  
Professional  
Group

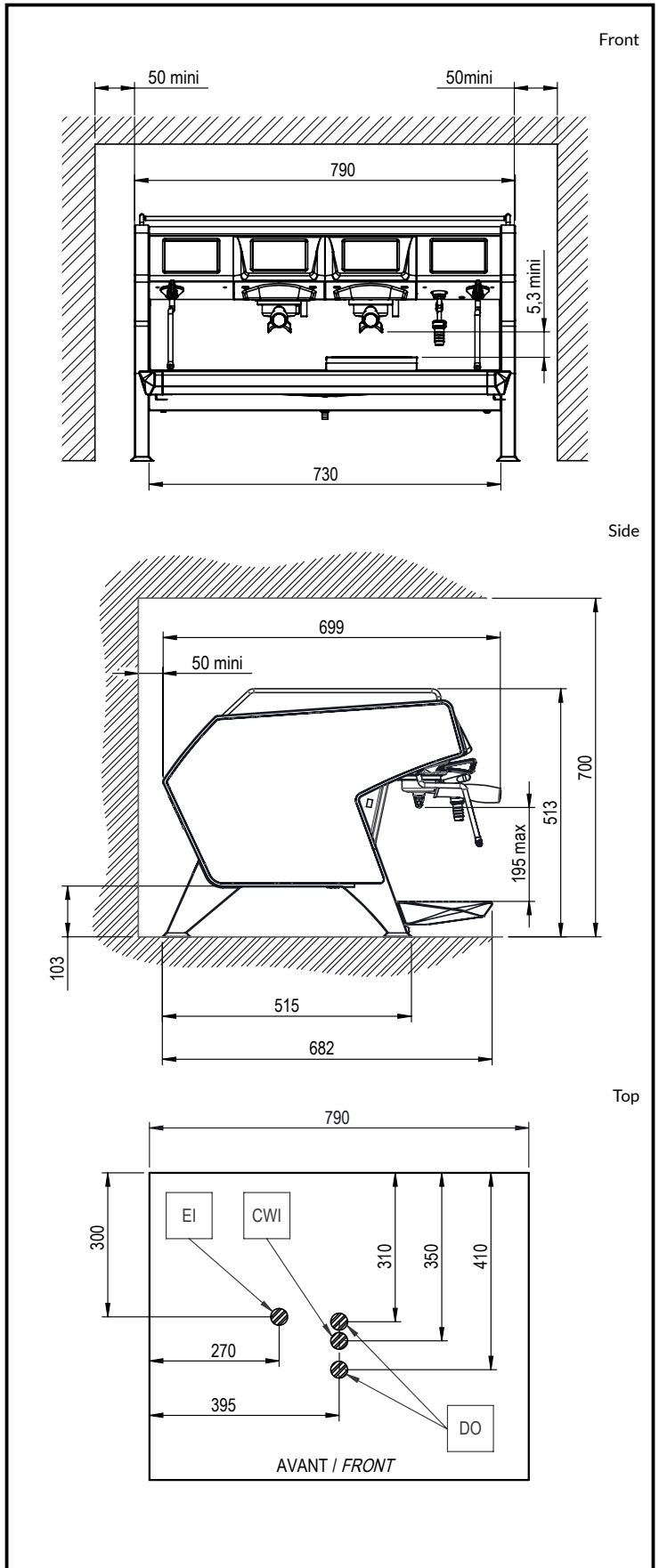

**UNIC**