

STELLA EPIC 2, Premium, Striped stainless steel



Ref602964 (EPIC2PREMIUMUL)

Specialty Espresso Machine

- 2 Groups
- Easylock Maestro Group
- Cool Touch Steam - Mitigated Hot Water - Cool Touch Steam
- Special Color
- 220 V 1N 60-Hz 6kW
- UL/NSF Certified

General Features

The Stella Epic, UNIC's flagship model, combines iconic 50s-inspired design with advanced digital technology, crafted for barista who seek to master coffee flavors. Ideal for high-traffic cafes, its multi-boiler system and Thermalink technology ensure precise temperature control and energy efficiency.

Key features like up to 5 recordable infusion profiles per group, Cool Touch steam wands, and the Easylock portafilter system enhance consistency and convenience for busy baristas. With the Stella Epic, elevate your coffee experience and impress customers with a blend of style, precision, and performance.

STELLA EPIC 2, Premium, Striped stainless steel

Main Features

- LCD touchscreen to take control of the settings, in expert mode it allows saving up to 5 recordable extraction profiles per group to enhance high quality coffees extraction.
- 2 independent control boxes with 4 programmable dosing selection, start/stop, pre and post infusion profiling manual control, infusion pressure curve and shot time display
- Cool touch steam outlets to control steam without the risk of burns, easier to clean after each use
- Easily height-adjustable drip tray to adapt the working area
- 8.9 liter hot water & steam boiler
- 2 x 1.65 liter boilers for coffee
- LED lights on group head
- Programmable water and steam.
- Automatic cleaning cycle.
- Electronic pre infusion.
- Double paneled cup warmer with large capacity.
- USB interface for update.
- Striped Stainless steel esthetic color body
- Manual Steamglide lever.

Construction

- PID (proportional-integral-derivative) Temperature control: a precise controller algorithm system that gives consistency and accuracy to brewing temperature management system.
- Easylock portafilter.
- RS-232 protocol for computer/cashier interface.
- Built-in cup warmer.

Sustainability

- Multi-boiler traditional espresso machine with Thermalink Network® technology that intelligently controls and optimizes the distribution of heat, that guarantees consistent brewing temperature and efficiency in terms of energy requirements.

STELLA EPIC 2, Premium, Striped stainless steel

Electric

Supply voltage: 220 V/1 ph/60 Hz

Electrical power, max: 6.13 kW

Plug type:

Water:

Cold water temperature (min/max): 5 / 60 °C

Key Information:

External dimensions, Height: 20 3/16" (513 mm)

External dimensions, Weight: 198 lbs (90 kg)

Net weight: 198 lbs (90 kg)

Shipping width: 43 5/16" (1100 mm)

Shipping depth: 29 1/2" (750 mm)

Shipping height: 33 1/16" (840 mm)

Shipping weight: 236 lbs (107 kg)

Shipping volume: 0.7 m³

Certifications



The company reserves the right to make modifications to the products without prior notice. All information correct at time of printing.

2026.04.21

Part of  Electrolux Professional Group

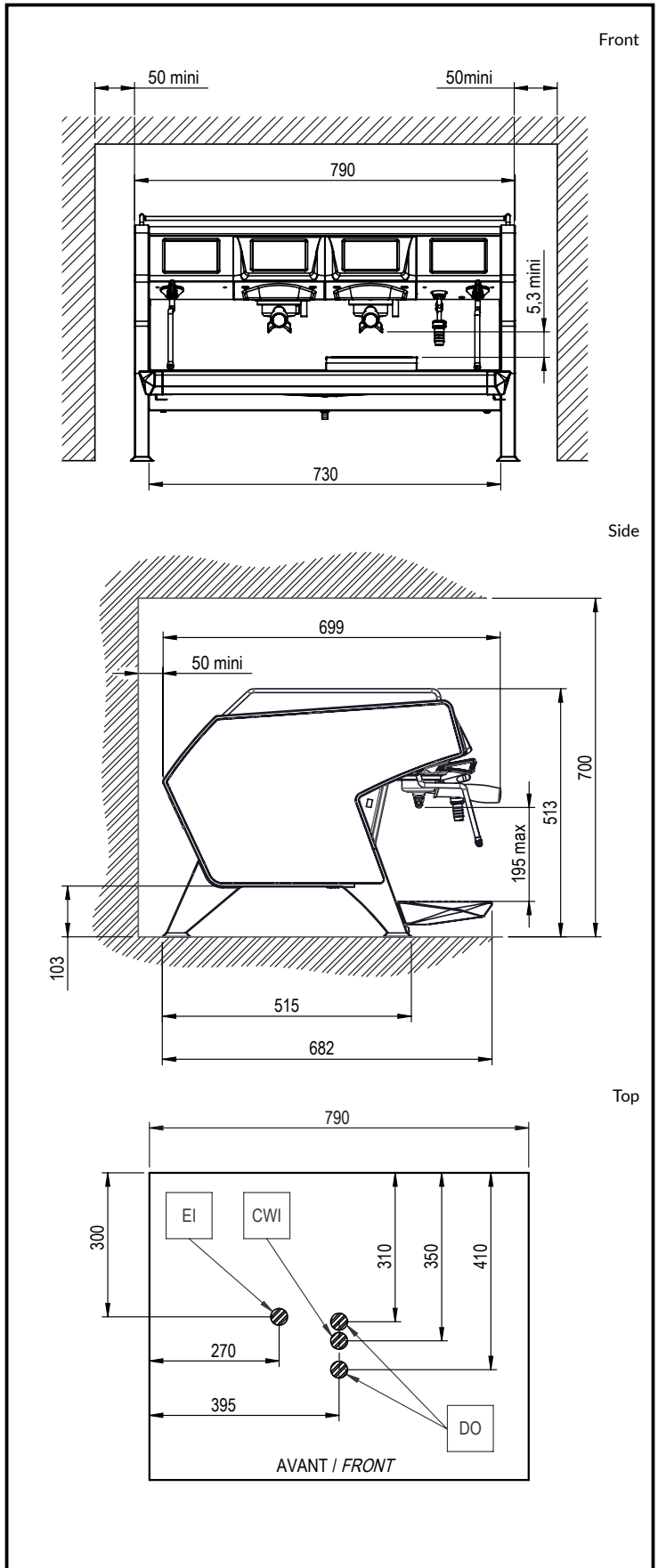

UNIC