

TANGO ACE 120, Steamair



Ref602739 (ACE120SAUL)

Super automatic two-step espresso maker, 1 group, 6,5 liter steam/coffee boiler, 1x1,7 kg and 1x1,2 kg coffee hopper, programmable water, Steamair

General Features

Super automatic two-step espresso maker with automated steam and foaming wand for milk drinks. This unit is typically operated for capacities upward of 25 lbs. per week. Designed for rugged commercial application and high performance during rush periods. 60,000 cycle piston seals require the Tango the least amount of intervention. Its stainless steel brewing chamber and software design replicate and consistently deliver infusion parameters found in barista controlled equipment. Adjustable and transferable settings via touch screen or USB key.

TANGO ACE 120, Steamair

Main Features

- Auto cleaning program.
- 1 group full-automatic machine.
- 6.5 liter steam/coffee boiler.
- Steamair milk auto-frother programmable outlet.
- The super automatic coffee machine Tango® Ace impresses its users with an exceptional result in every cup, and the quality of its equipment makes it a highly reliable choice for demanding professional use.
- The Tango® Ace comes in 3 different colors: shiny white, glossy black and brushed stainless steel, fitted with a new 7" color touch screen user interface. This full automatic coffee machine has a 48 drinks menu, all customizable and comprehensive with the addition of the Cappuccinatore device to process fresh into specialty coffee drinks as cappuccino, latte, mocha...
- Delivery capacity: Espresso 40ml: 220 cups/h Lungo 100ml: 150 cups/h Hot water: 30 L/h

Construction

- PID (proportional-integral-derivative) Temperature control: a precise controller algorithm system that gives consistency and accuracy to brewing temperature management system.
- 2 coffee grinders (1 x 1,7 kg & 1 x 1,2 kg coffee hoppers).
- LCD Touchscreen.

Optional Accessories

- KIT OF RAISED 3" FEET PNC 871041

TANGO ACE 120, Steamair

Electric

Supply voltage:

602739
(ACE120SAUL) 208-240 V/1 ph/60 Hz

Electrical power, max: 5.5 kW

Plug type:

Water:

Cold water temperature
(min/max): 5 / 60 °C

Key Information:

External dimensions,
Width: 17 5/8" (448 mm)

External dimensions,
Depth: 24 11/16" (627 mm)

External dimensions,
Height: 33 5/16" (846 mm)

External dimensions,
Weight: 227 lbs (103 kg)

Net weight: 227 lbs (103 kg)

Shipping width: (1100 mm)

Shipping depth: (750 mm)

Shipping height: (840 mm)

Shipping weight: lbs (122 kg)

Shipping volume: 0.7 m³

Certifications



The company reserves the right to make modifications to the products without prior notice. All information correct at time of printing.

2024.09.01

Part of



Electrolux
Professional
Group

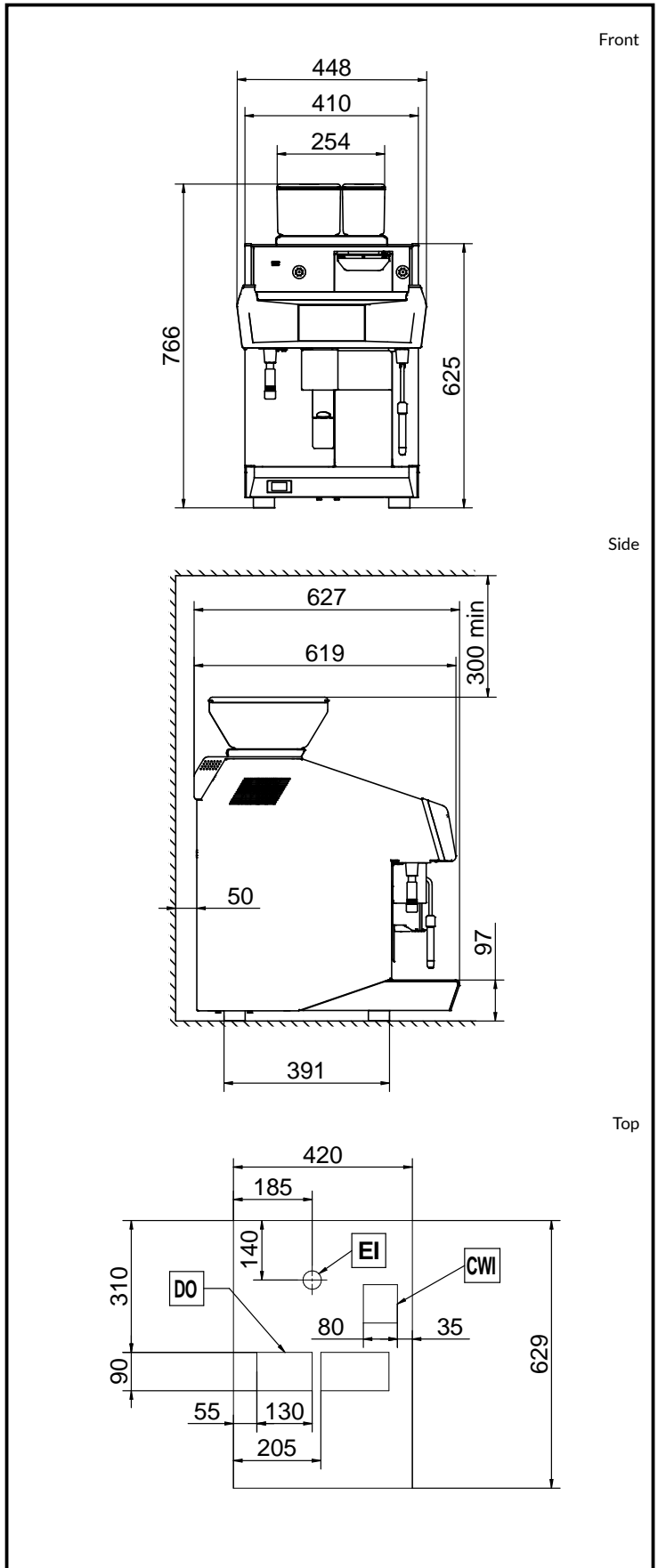

UNIC