

Classic e 3 groups



Ref: 604065
(CH3.CE.400.4.7K)

Traditional Espresso Machine

- 3 Groups
- Cool Touch Steam - Hot Water - Cool Touch Steam
- Inox
- 400 V 3N 50~Hz 4,7kW
- CE/CB Certified

General Features

The Classic e's elegant lines are underlined by a control board featuring new control buttons. User-friendly and low-maintenance, it delivers features that ensure perfect coffee extraction of consistent quality, and high performance during periods of intensive use.

Classic e 3 groups

Main Features

- Heavy duty components and welded construction, a direct mounted boiler group head for thermal stability and reliable extraction, easy access to components for uncomplicated servcability, and unlimited steam.
- Maestro brew group: directly to boiler group heads are mounted for shot temperature stability.
- 4 programmable volume keys per group + Semi-automatic key for each group for manual control.
- Programmable water and steam.
- Automatic cleaning cycle.
- Manual Steamglide lever.
- Cool touch steam outlets to control steam without the risk of burns, easier to clean after each use

Construction

- Built-in cup warmer.
- Stainless steel body.
- PID (proportional-integral-derivative) Temperature control: a precise controller algorithm system that gives consistency and accuracy to brewing temperature management system.

Sustainability

- Standby mode for controlled management of energy consumption

Included Accessories

- 1 of Filter holder for one cup PNC 871002
- 3 of Filter holder for two cups PNC 871003

Optional Accessories

- Filter holder for one cup PNC 871002
- Filter holder for two cups PNC 871003
- Filter holder for three cups PNC 871004
- Knock box drawer for 3-group machines PNC 871007
- Filter for one cup, 12 gr PNC 871017
- Filter for two cups, 18 gr PNC 871018
- Stainless steel knock box drawer PNC 871019

Classic e 3 groups

Electric

Supply voltage:	400 V/3N ph/50/60 Hz
Electrical power, max:	4.7 kW
Current consumption:	7.2 Amps
Plug type:	Cable without plug

Water:

Cold water temperature (min/max):	5 / 60 °C
-----------------------------------	-----------

Key Information:

Net weight:	76 kg
Shipping weight:	97 kg
Shipping height:	840 mm
Shipping width:	1320 mm
Shipping depth:	750 mm
Shipping volume:	0.83 m ³

Certifications



The company reserves the right to make modifications to the products without prior notice. All information correct at time of printing.

2026.04.14

Part of  Electrolux Professional Group

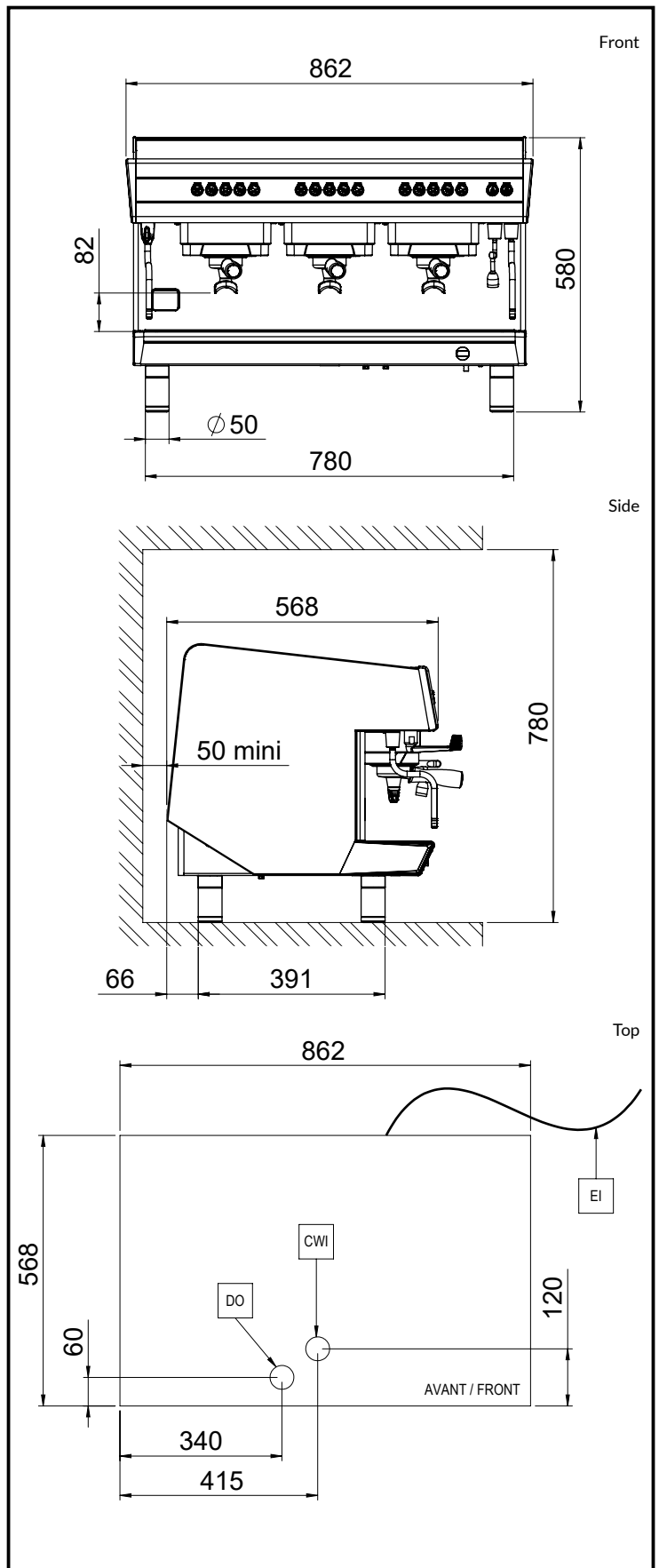

UNIC