

STELLA EPIC 3, Dosamat technology, black color



**Ref: 602686
(EPIC3DOB)**

Multi-boilers espresso machine black esthetic color, 3 groups, 3 x 1.65 liter boilers for coffee, 14,3 liter hot water & steam boiler, Central control LCD Touch screen, 3 independent control boxes with 4 programmable dosing program with Dosamat® self recognition of portafilter- Thermalink Network, programmable pre-infusion time per group, Steamglide, programmable steam cool touch & water, automatic cleaning cycle, Easylock portafilter, stainless steel body

General Features

The Stella Epic is the flagship for UNIC, with an assertive design inspired from the 50's and a technology fully deep-seated in the digital era, it offers high-end features geared towards the barista keen to explore coffees aromas with high precision.

The Stella Epic is a multi-boiler traditional espresso machine machine that guarantees exceptional brewing with its Thermalink Network® technology and a PID controller for a consistent brewing temperature. Its expert mode gives full control of the settings and allows saving up to 5 recordable extraction profiles per group to enhance high quality coffees extraction. Its brew groups are fitted with the EASYLOCK system that help locking and sealing the portafilter with minimal effort. DOSAMAT® technology gives also a high level of performance thanks to the autorecognition of the size of portafilter and the automatic dosing execution. Customization and several options exist and complete the Stella Epic standard equipment, so make it Yours! The Stella Epic is the ideal commercial espresso machine for baristas, as well as for coffee shops and businesses offering specialty coffee beverages that call for precise adjustments and maximum steam capacity.

STELLA EPIC 3, Dosamat technology, black color

Main Features

- 14,3 liter hot water & steam boiler
- Manual Steamglide lever.
- LCD touchscreen to take control of the settings, in expert mode it allows saving up to 5 recordable extraction profiles per group to enhance high quality coffees extraction.
- Black esthetic color body
- LED lights on group head
- Programmable water and steam.
- Automatic cleaning cycle.
- Electronic pre infusion.
- Double paneled cup warmer with large capacity.
- USB interface for update.
- 3 independent control boxes with 4 programmable dosing selection with Dosamat ® self recognition of portafilter, pre and post infusion profiling manual control, infusion pressure curve and shot time display
- Cool touch steam outlets to control steam without the risk of burns, easier to clean after each use
- Easily height-adjustable drip tray to adapt the working area
- 3 x 1.65 liter boilers for coffee

Construction

- PID (proportional-integral-derivative) Temperature control: a precise controller algorithm system that gives consistency and accuracy to brewing temperature management system.
- Easylock portafilter.
- RS-232 protocol for computer/cashier interface.
- Built-in cup warmer.

Sustainability

- Multi-boiler traditional espresso machine with Thermalink Network® technology that intelligently controls and optimizes the distribution of heat, that guarantees consistent brewing temperature and efficiency in terms of energy requirements.

STELLA EPIC 3, Dosamat technology, black color

Electric

Supply voltage:

602686 (EPIC3DOB) 380-415 V/3N
ph/50/60 Hz

Electrical power max.: 7.5 kW

Plug type: Cable without plug

Water:

Cold water temperature
(min/max): 5 / 60 °C

Key Information:

External dimensions,
Width: 980 mm

External dimensions,
Depth: 682 mm

External dimensions,
Height: 513 mm

Net weight: 100 kg

Shipping volume: 0.83 m³

Sustainability

ISO 9001; ISO 14001

Current consumption: Amps

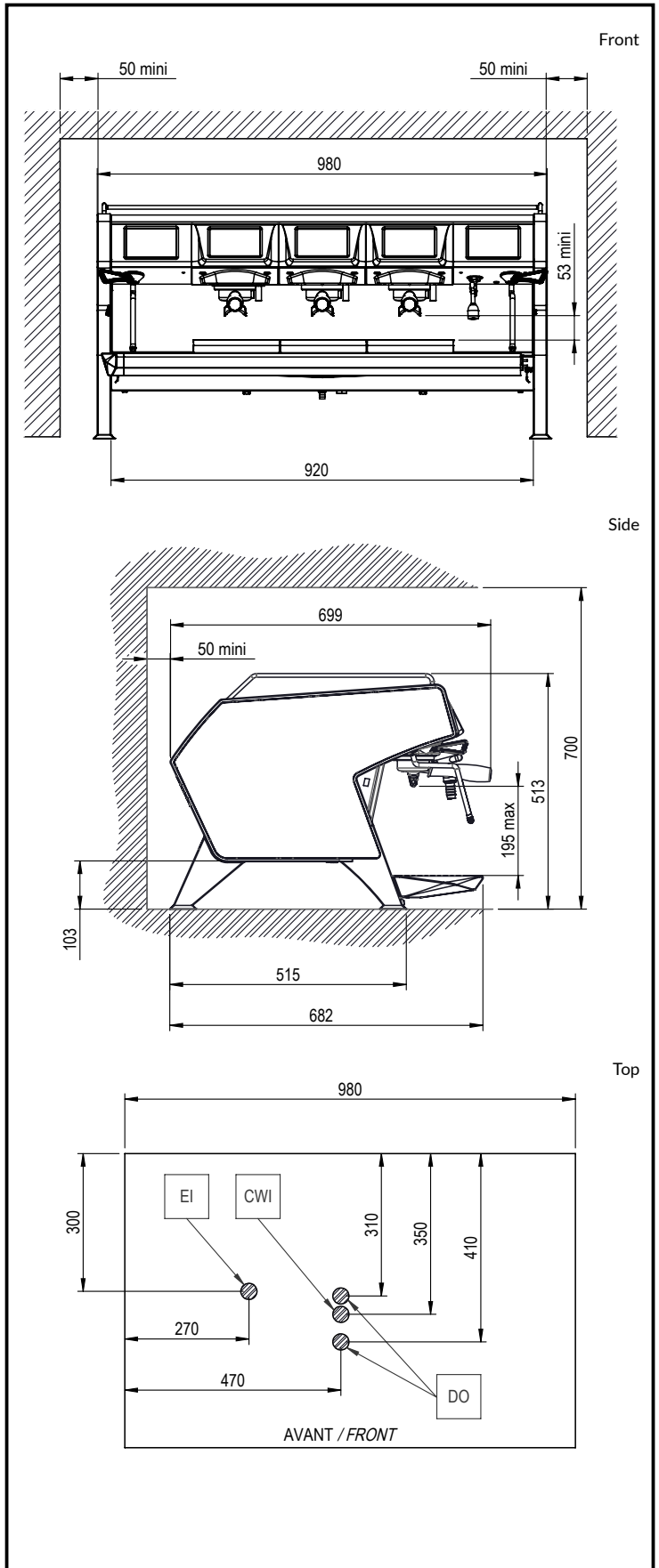

Certifications



The company reserves the right to make modifications to the products without prior notice. All information correct at time of printing.

2024.06.24

Part of  Electrolux
Professional
Group

UNIC