

TANGO ACE 121, Cappuccinatore device



Ref: 602618
(UTANGOACE1LC)

Super Automatic Espresso Machine

- 1 Group
- 2 Grinders
- Cappuccinator - Teflon Steam - Std Hot Water
- 380-415V 3N 50/60~Hz
- CE/CB Certified
- Shiny Black

General Features

The Tango® Ace impresses its users with an exceptional result in every cup, and the quality of its equipment makes it a highly reliable choice for demanding professional use.

The Tango® Ace fitted with a 7 inches touchscreen, offers a 48 drinks menu, all customizable. Milk-based drinks can be easily prepared with the Cappuccinator device or the Steamair milk auto-frother to process fresh milk into specialty coffee drinks as cappuccino, latte, mocha...

TANGO ACE 121, Cappuccinatore device

Main Features

- 1 group full-automatic machine.
- 6.5 liter steam/coffee boiler.
- Auto cleaning program.
- Programmable water and steam.
- Tango Cappuccinatore device with double feature L: for hot milk and C: for foam by air injection.
- The super automatic coffee machine Tango® Ace impresses its users with an exceptional result in every cup, and the quality of its equipment makes it a highly reliable choice for demanding professional use.
- The Tango® Ace comes in 3 different colors: shiny white, glossy black and brushed stainless steel, fitted with a new 7" color touch screen user interface. This full automatic coffee machine has a 48 drinks menu, all customizable and comprehensive with the addition of the Cappuccinatore device to process fresh into specialty coffee drinks as cappuccino, latte, mocha...

- Delivery Capacity:

Espresso 40ml: 220 cups/h

Lungo 100ml: 150 cups/h

Hot Water: 30 L/h

Cappuccino 100ml: 170 cups/h

Latte 100ml: 150 cups/h

Construction

- 2 coffee grinders (1 x 1,7 kg & 1 x 1,2 kg coffee hoppers).
- LCD Touchscreen.
- PID (proportional-integral-derivative) Temperature control: a precise controller algorithm system that gives consistency and accuracy to brewing temperature management system.

TANGO ACE 121, Cappuccinatore device

Electric

Supply voltage: 400 V/3N ph/50 Hz

Electrical power, max: 5.2 kW

Plug type: Cable without plug

Water:

Cold water temperature (min/max): 5 / 60 °C

Key Information:

Net weight: 103 kg

Shipping volume: 0.69 m³

Sustainability

Current consumption: 7.5 Amps

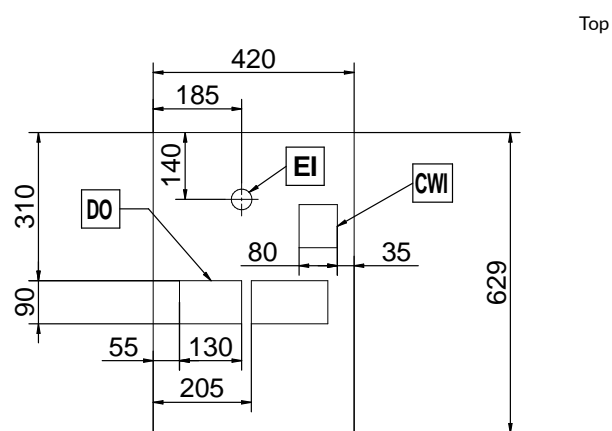
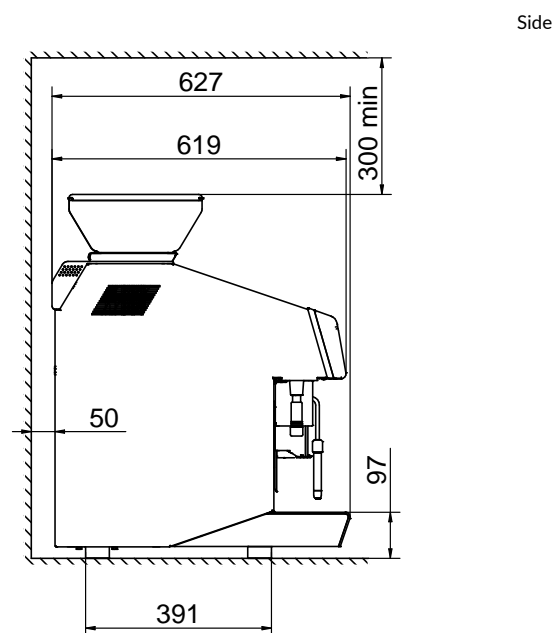
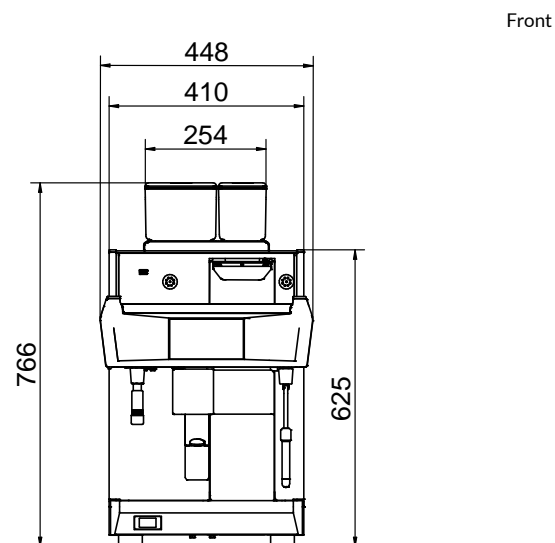

Certifications



The company reserves the right to make modifications to the products without prior notice. All information correct at time of printing.

2026.04.18

Part of  Electrolux Professional Group

UNIC