

TANGO ACE MT, Cappuccinatore device



Ref: 602622 (UTANGOACEMTLC)

Full-automatic machine, 1 group, 220x40 ml espresso cup/hr, 6,5 liter steam/coffee boiler, 1x1,7 kg coffee hopper for beans, 0,8-1,5 kg hopper for powder, programmable water, Cappuccinatore device for hot milk and foam drinks

General Features

The super automatic multi-products Tango® ACE MT fully takes advantage of the exceptional extraction quality that has established the reputation of the TANGO® range, and the ability to work with powdered products such as cocoa.

The 48 hot drinks menu, for breakfast or gourmet coffee breaks along the day, is fully programmable through the 7" touch screen interface.

To fulfill this entire drinks menu, the Tango® ACE MT can be fitted with the Cappuccinatore device to process fresh milk, into specialty coffee drinks as cappuccinos, lattes, mochas...

Delivery Capacity:

Espresso 40ml: 220 cups/h

Lungo 100ml: 150 cups/h

Hot chocolate 250ml: 110 cups/h

Cappuccino 100ml: 170 cups/h

Latte 100ml: 150 cups/h

Latte macchiato 300ml: 80 cups/h

Hot Water: 30 L/h

TANGO ACE MT, Cappuccinatore device

Main Features

- 1 group full-automatic machine.
- 6.5 liter steam/coffee boiler.
- Auto cleaning program.
- Programmable water and steam.
- Tango Cappuccinatore device with double feature L: for hot milk and C: for foam by air injection.
- The 48 hot drinks menu , for breakfast or gourmet coffee breaks along the day, is fully programmable through the 7" touch screen interface.
- The super automatic multi-products Tango® ACE MT fully takes advantage of the exceptional extraction quality that has established the reputation of the TANGO® range, and the ability to work with powdered products such as cocoa.
- To fulfill this entire drinks menu, the Tango® ACE MT can be fitted with the Cappuccinatore device to process fresh milk, into specialty coffee drinks as cappuccinos, lattes, mochas...
- Delivery Capacity:

Espresso 40ml: 220 cups/h

Lungo 100ml: 150 cups/h

Hot chocolate 250ml: 110 cups/h

Cappuccino 100ml: 170 cups/h

Latte 100ml: 150 cups/h

Latte macchiato 300ml: 80 cups/h

Hot Water: 30 L/h

Construction

- 1 x 1,7 kg coffee hopper & grinders + (0,8 at 1,5) kg hopper for powder.

Optional Accessories

- Side milk refrigerator 8 liter nominal capacity for up to 4 liter milk containers PNC 871014
- Side milk refrigerator 8 liter nominal capacity for up to 4 liter milk containers with digital display PNC 871015
- TANGO hotel/breakfast service kit PNC 871022
- Coffee ground direct discharge chute PNC 871023

TANGO ACE MT, Cappuccinatore device

Electric

Supply voltage:

602622
(UTANGOACEMTLC) 400 V/3N ph/50 Hz

Electrical power max.: 5.2 kW

Plug type: Cable without plug

Water:

Cold water temperature
(min/max): 5 / 60 °C

Key Information:

External dimensions,
Width: 448 mm

External dimensions,
Depth: 627 mm

External dimensions,
Height: 766 mm

Net weight: 91 kg

Shipping volume: 0.69 m³

Sustainability

Current consumption: 14.5 Amps

Certifications



The company reserves the right to make modifications to the products without prior notice. All information correct at time of printing.

2024.02.09

Part of  Electrolux
Professional
Group

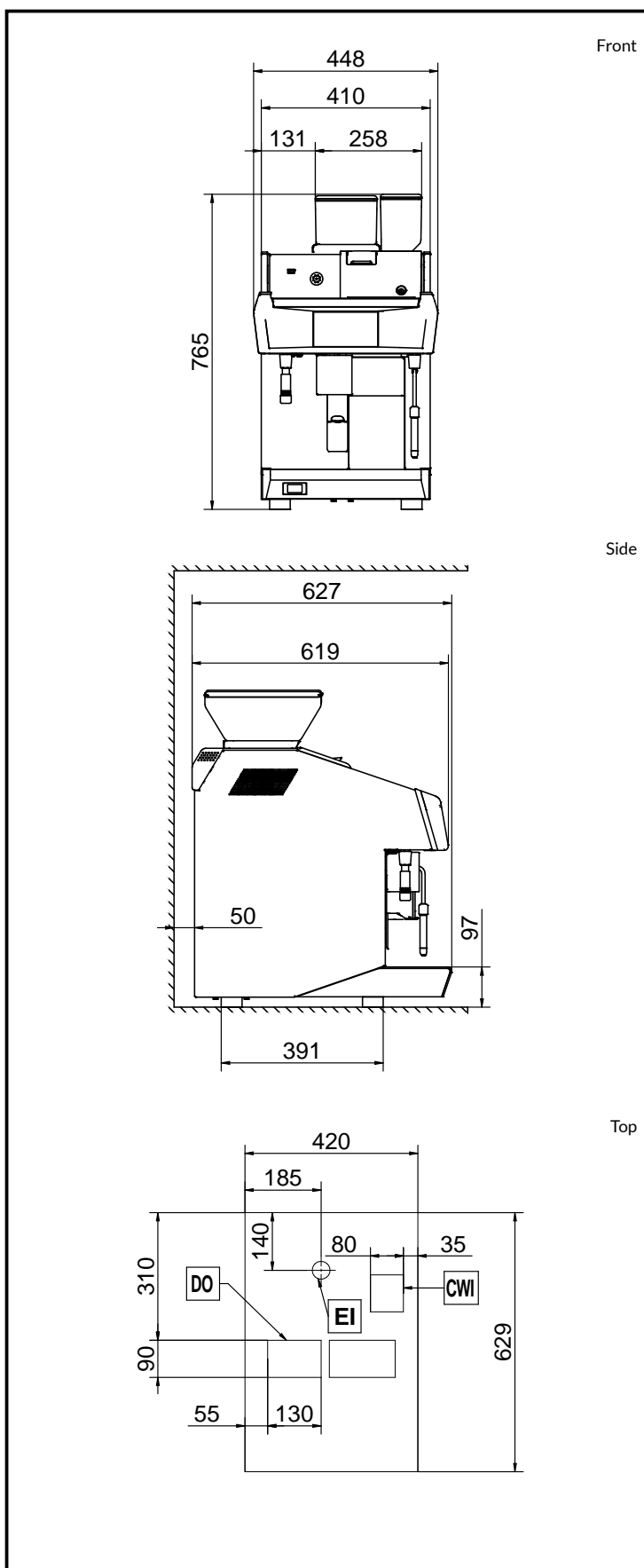

UNIC