

**Modular Cooking Range Line
EVO900 Base Cupboard 1/4
Module with Bottle Drawer**

ITEM # _____

MODEL # _____

NAME # _____

SIS # _____

AIA # _____



391152 (E9BANB000E)

Base cupboard with drawer
for bottles, 1/4 module

Short Form Specification

Item No. _____

To be installed below other EVO900 top units in island type installations with operations from one side. Body and internal structure of unit entirely in stainless steel. Drawer for bottles. Delivered with 50 mm height adjustable feet.

Main Features

- Unit can be easily installed below other 900 line top models.
- Unit delivered with 50 mm height adjustable feet in Stainless steel.
- Base compartment for storage of pots, pans, sheet pans, etc.
- Doors with handles, drawers, heating kits and runners for GN containers can be ordered separately.

Construction

- Constructed in Stainless steel with Scotch Brite finish to meet the highest hygiene standards.

Optional Accessories

- 4 wheels, 2 swivelling with brake (EVO700/900). It is mandatory to install with base supports for feet/wheels. PNC 206135
- Flanged feet kit PNC 206136
- Frontal kicking strip for concrete installation, 200 mm PNC 206146
- Frontal kicking strip for concrete installation, 400 mm PNC 206147
- Frontal kicking strip for concrete installation, 800 mm PNC 206148
- Frontal kicking strip for concrete installation, 1000 mm PNC 206150
- Frontal kicking strip for concrete installation, 1200 mm PNC 206151
- Frontal kicking strip for concrete installation, 1600 mm PNC 206152
- 2 SIDE KICKING STRIPS-CONCRETE INST-900 PNC 206157
- Frontal kicking strip, 200 mm PNC 206174
- Frontal kicking strip, 400 mm PNC 206175
- Frontal kicking strip, 800 mm PNC 206176
- Frontal kicking strip, 1000 mm PNC 206177
- Frontal kicking strip, 1200 mm PNC 206178
- Frontal kicking strip, 1600 mm PNC 206179
- Pair of side kicking strips PNC 206180
- 4 feet for concrete installation (not for 900 line freestanding grill) PNC 206210
- 2 side covering panels, height 700 mm, depth 900 mm PNC 206335
- Base support for feet or wheels - 400mm (EVO700/900) PNC 206366
- Base support for feet or wheels - 800mm (EVO700/900) PNC 206367
- Base support for feet or wheels - 1200mm (EVO700/EVO900) PNC 206368
- Base support for feet or wheels - 1600mm (EVO700/900) PNC 206369
- Base support for feet or wheels - 2000mm (EVO700/900) PNC 206370

APPROVAL: _____



Modular Cooking Range Line EVO900 Base Cupboard 1/4 Module with Bottle Drawer

- Rear paneling - 600mm (EVO700/900) PNC 206373
- Rear paneling - 800mm (EVO700/900) PNC 206374
- Rear paneling - 1000mm (EVO700/900) PNC 206375
- Rear paneling - 1200mm (EVO700/900) PNC 206376
- Base support for feet/wheels (600mm) PNC 206431



**Modular Cooking Range Line
EVO900 Base Cupboard 1/4 Module with Bottle Drawer**

The company reserves the right to make modifications to the products without prior notice. All information correct at time of printing.

2024.08.30

Front

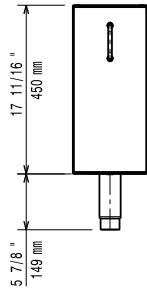

Side

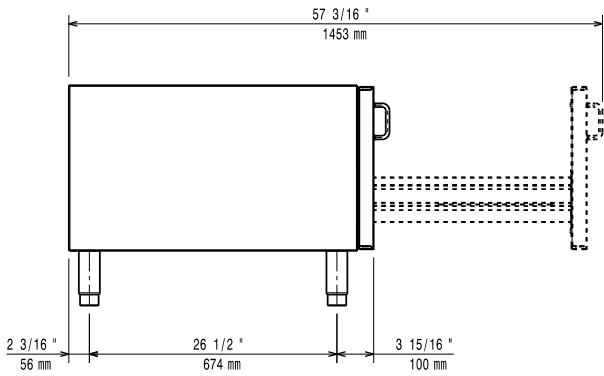

Top

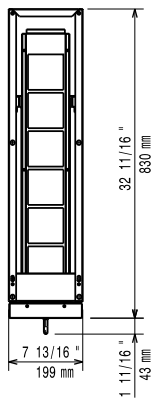

Key Information:

External dimensions, Width:	
391152 (E9BAN000E)	200 mm
External dimensions, Depth:	900 mm
External dimensions, Height:	600 mm
Net weight:	14 kg