

Modular Cooking Range Line EVO700 800mm Electric Fry Top, Smooth Brushed Chrome Plate

ITEM # _____

MODEL # _____

NAME # _____

SIS # _____

AIA # _____

**372340 (Z7IIKDAOMEA)**

Full module electric fry top with smooth brushed chrome cooking plate, sloped, thermostatic control, scraper included

372322 (Z7IIKIAOMEA)

Full module electric fry top with smooth brushed chrome cooking plate, sloped, 230V, thermostatic control, scraper included

Short Form Specification

Item No. _____

To be installed on open base installations or bridging supports. Smooth cooking surface in brushed chrome. Temperature range from 120°C to 280°C. Removable drawer below the cooking surface for the collection of grease and fat. Exterior panels in stainless steel with Scotch Brite finish. One piece pressed work top in 1.5 mm thick stainless steel. Right-angled side edges to allow flush-fitting junction between units.

Main Features

- Unit to be mounted on open base cupboards, bridging supports or cantilever systems.
- Large drain hole on cooking surface permits the draining of fat into large 1,5 liter collector placed under the cooking surface.
- Large grease collection container available as optional accessory to be installed under top units over open base cupboard.
- Safety thermostat and thermostatic control.
- Stainless steel high splash guard on the rear and sides of cooking surface. Splash guard can be easily removed for cleaning.
- IPx4 water protection.
- Infrared heating elements mounted below the cooking surface.
- Frontal simmering zone.
- Temperature range from 120° up to 280°C.
- Rough brushed chrome surface is highly resistant to scratches and facilitates cleaning operations at the end of the day.
- Scraper for smooth plate included as standard.
- Suitable for countertop installation.

Construction

- Cooking surface completely smooth.
- Exterior panel in Stainless Steel with Scotch Brite finish.
- One piece pressed 1.5 mm work top in Stainless steel.
- Model has right-angled side edges to allow flush fitting joints between units, eliminating gaps and possible dirt traps.
- Cooking surface 12mm thick brushed chrome for optimum grilling results and ease of use.

APPROVAL: _____



Modular Cooking Range Line EVO700 800mm Electric Fry Top, Smooth Brushed Chrome Plate

Included Accessories

- 1 of Scraper for smooth plate for fry tops PNC 164255

Optional Accessories

- Scraper for smooth plate for fry tops PNC 164255
- Junction sealing kit PNC 206086
- Support for bridge type installation, 800 mm PNC 206137
- Support for bridge type installation, 1000 mm PNC 206138
- Support for bridge type installation, 1200 mm PNC 206139
- Support for bridge type installation, 1400 mm PNC 206140
- Support for bridge type installation, 1600 mm PNC 206141
- Frontal handrail 800 mm PNC 206167
- Large handrail (portioning shelf) 800 mm PNC 206186
- Frontal handrail 1200 mm PNC 206191
- Frontal handrail 1600 mm PNC 206192
- Right and left side handrails PNC 206240
- Chimney upstand, 800 mm PNC 206304
- 2 side covering panels, height 250 mm, depth 700 mm PNC 206320
- Grease/oil container kit for frytops PNC 206346
- Base support for feet or wheels - 800mm (EVO700/900) PNC 206367
- Chimney grid net, 400mm PNC 206400
- Cloche for fry tops PNC 206455



Modular Cooking Range Line
EVO700 800mm Electric Fry Top, Smooth Brushed Chrome Plate

The company reserves the right to make modifications to the products without prior notice. All information correct at time of printing.

2024.04.16

Modular Cooking Range Line EVO700 800mm Electric Fry Top, Smooth Brushed Chrome Plate

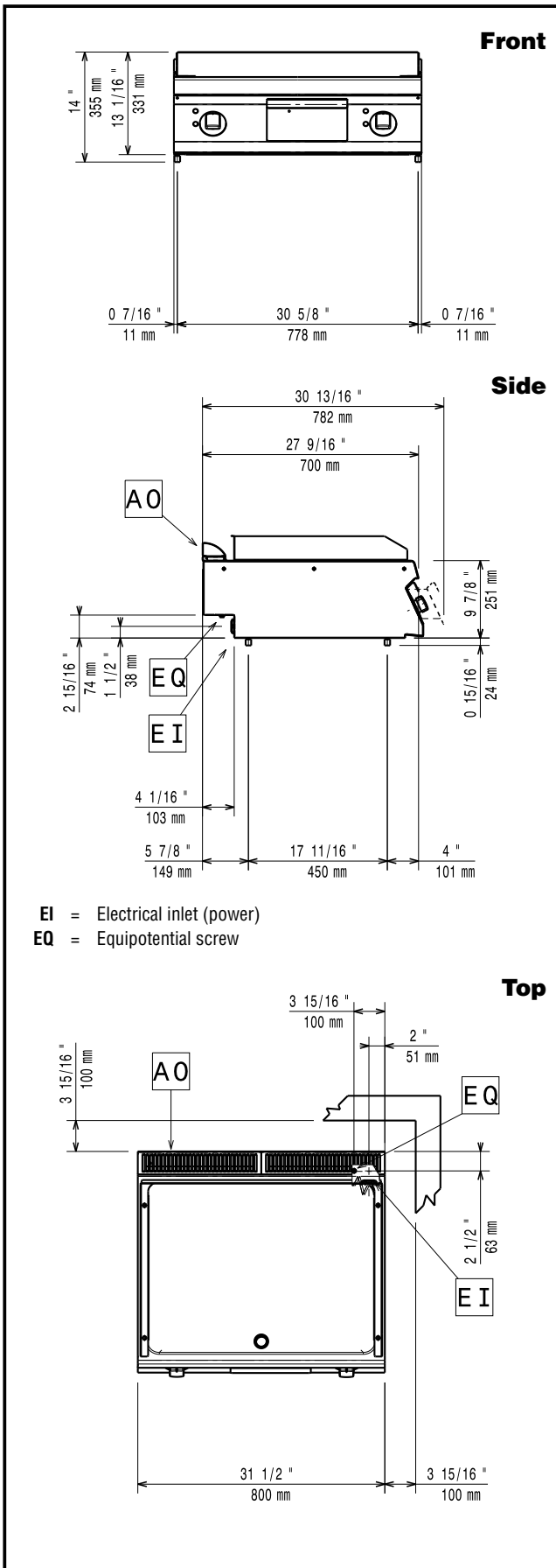

Electric

Supply voltage:

372340 (Z7IIKDAOMEA)	400 V/3 ph/50/60 Hz
372322 (Z7IIKIAOMEA)	230 V/3 ph/50/60 Hz

Electrical power max.:

372340 (Z7IIKDAOMEA)	8.4 kW
372322 (Z7IIKIAOMEA)	7.8 kW

Total Watts:

372340 (Z7IIKDAOMEA)	8.4 kW
372322 (Z7IIKIAOMEA)	7.8 kW

Predisposed for:

372340 (Z7IIKDAOMEA) 380-400V 3~ 50/60Hz 7.6-8.4kW

Key Information:

Cooking surface width:	730 mm
Cooking surface depth:	540 mm
Working Temperature MIN:	120 °C
Working Temperature MAX:	280 °C
External dimensions, Width:	800 mm
External dimensions, Depth:	700 mm
External dimensions, Height:	250 mm
Net weight:	70 kg

Shipping weight:

372340 (Z7IIKDAOMEA)	73 kg
372322 (Z7IIKIAOMEA)	84 kg

Shipping height:

540 mm

Shipping width:

820 mm

Shipping depth:

860 mm

Shipping volume:

0.38 m³

If appliance is set up or next to or against temperature sensitive furniture or similar, a safety gap of approximately 150 mm should be maintained or some form of heat insulation fitted.