

# Electrical and Gas Oven

## Combi TOUCH

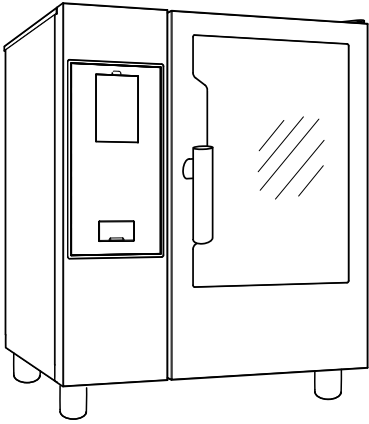

.....

EN-US      User Manual



## Foreword

 Read the following instructions, including the warranty terms before installing and using the appliance.

Visit our website [www.electroluxprofessional.com](http://www.electroluxprofessional.com) and open the Support section to:

---

 Register your product

 Get hints & tips of your product, service and repair information

---

The installation, use and maintenance manual (hereinafter Manual) provides the user with information necessary for correct and safe use of the appliance.

The following must not be considered a long and exacting list of warnings, but rather a set of instructions suitable for improving appliance performance in every respect and, above all, preventing injury to persons and animals and damage to property due to improper operating procedures.

All persons involved in appliance transport, installation, commissioning, use and maintenance, repair and disassembly must consult and carefully read this manual before carrying out the various operations, in order to avoid wrong and improper actions that could compromise the appliance's integrity or endanger people. Make sure to periodically inform the user regarding the safety regulations. It is also important to instruct and update personnel authorised to operate on the appliance, regarding its use and maintenance.

The manual must be available to operators and carefully kept in the place where the appliance is used, so that it is always at hand for consultation in case of doubts or whenever required.

If, after reading this manual, there are still doubts regarding appliance use, do not hesitate to contact the Manufacturer or the authorised Service Centre to receive prompt and precise assistance for better operation and maximum efficiency of the appliance. During all stages of appliance use, always respect the current regulations on safety, work hygiene and environmental protection. It is the user's responsibility to make sure the appliance is started and operated only in optimum conditions of safety for people, animals and property.



### IMPORTANT

- The manufacturer declines any liability for operations carried out on the appliance without respecting the instructions given in this manual.
- The manufacturer reserves the right to modify the appliances presented in this publication without notice.
- No part of this manual may be reproduced.
- This manual is available in digital format by:
  - contacting the dealer or reference customer care;
  - downloading the latest and up to date manual on the web site [www.electroluxprofessional.com](http://www.electroluxprofessional.com);
- The manual must always be kept in an easily accessed place near the appliance. Appliance operators and maintenance personnel must be able to easily find and consult it at any time.

# Contents

A	WARNING AND SAFETY INFORMATION .....	5
A.1	General information .....	5
A.2	Personal protection equipment.....	6
A.3	General safety .....	7
A.4	Protection devices installed on the appliance .....	8
A.5	Safety signs to be placed on the appliance or near its area .....	8
A.6	Reasonably foreseeable improper use .....	8
A.7	Residual risks.....	9
A.8	Appliance cleaning .....	10
A.9	Preventive Maintenance .....	10
A.10	Parts and accessories .....	10
A.11	Precautions for use and maintenance .....	10
A.12	Appliance maintenance .....	11
B	WARRANTY.....	11
B.1	Warranty terms and exclusions .....	11
C	GENERAL INFORMATION .....	12
C.1	Introduction.....	12
C.2	Intended use and restrictions .....	12
C.3	Testing and inspection .....	12
C.4	Copyright .....	12
C.5	Keeping the manual.....	12
C.6	Recipients of the manual .....	12
C.7	Definitions .....	12
C.8	Responsibility.....	12
D	NORMAL MACHINE USE .....	13
D.1	Characteristics of personnel enabled to operate on the appliance .....	13
D.2	Basic requirements for appliance use .....	13
E	PRODUCT DESCRIPTION.....	13
E.1	Use – Introduction .....	13
E.2	Notice.....	13
E.3	Appliance overview.....	14
E.4	Opening and closing the oven door .....	14
E.5	Control panel.....	15
F	OPERATING .....	15
F.1	SWITCH THE OVEN ON .....	15
F.2	MAIN MENU .....	16
F.3	OVEN CONNECTIVITY.....	17
F.4	TOUCH SCREEN COMMANDS / INFO AND DISPLAY MESSAGES .....	17
F.5	DRAWERS AREA .....	18
F.6	MANUAL MODE.....	19
F.6.1	MAIN PAGE .....	19
F.6.2	COOKING CYCLES.....	19
F.6.3	SETTING A COOKING CYCLE .....	20
F.6.4	DELAY START.....	20
F.6.5	START OPTIONS.....	21
F.6.6	END CYCLE.....	22
F.6.7	TEMPERATURE OPTIONS .....	22
F.6.8	HUMIDITY OPTION .....	23
F.6.9	TIME OPTION .....	24
F.6.10	FOOD CORE PROBE OPTION .....	24
F.6.11	MULTITIMER OPTION .....	26
F.6.12	MULTIPHASE DRAWER.....	27
F.7	AUTOMATIC MODE .....	29
F.7.1	SET AN AUTOMATIC CYCLE .....	29
F.7.2	UPDATE/RESTORE AUTOMATIC CYCLES.....	31
F.7.3	CYCLES+ / SPECIAL CYCLES .....	33
F.8	PROGRAMS MODE .....	37
F.9	HOME PAGE FAVORITES MODE (SKYHUB/SOLOMIO).....	42
F.10	HELP MODE.....	42
F.11	AGENDA MODE (CALENDAR – MY PLANNER) .....	43
F.12	USB MODE .....	45
F.13	PLAN&SAVE/COOKING OPTIMIZER MODE.....	47
F.14	SKYDUO/MATCH MODE (depending on your model - optional) .....	49
F.15	HOOD MANAGEMENT .....	51
F.16	CLEANING MODE .....	51
F.16.1	FORCED CLEANING .....	55
F.16.2	BOILER DESCALING.....	56
F.17	SETTINGS .....	56

F.17.1	LANGUAGE	56
F.17.2	DATE	57
F.17.3	TIME	57
F.17.4	MEASUREMENT UNITS	57
F.17.5	SOUND	57
F.17.6	CAVITY LIGHT	57
F.17.7	DISPLAY	57
F.17.8	TOUCH SCREEN CALIBRATION	57
F.17.9	TOUCH SCREEN TEST	58
F.17.10	FOOD SAFETY	58
F.17.11	AUTOSTART	58
F.17.12	MANUAL	58
F.17.13	AUTOMATIC	59
F.17.14	PROGRAMS	60
F.17.15	MULTITIMER	61
F.17.16	HOME PAGE FAVORITE MODE	61
F.17.17	CLEANING	61
F.17.18	GREEN SPIRIT/ECONOMIZER	62
F.17.19	ACCESSORIES	62
F.17.20	STARTUP PAGE	62
F.17.21	IDENTITY CARD	62
F.17.22	USER PASSWORD	62
F.17.23	SERVICE	63
F.18	SWITCH THE OVEN OFF	63
G	OVEN CARE	64
G.1	Care information	64
G.2	Cleaning introduction	64
G.3	Appliance cleaning	64
G.4	Cooking chamber	64
G.5	Boiler or steam generator (models equipped only)	64
G.6	Cooking chamber filter	64
G.7	Air filter	64
G.8	Door gasket	65
G.9	Inner, outer and cooking chamber glass	65
G.10	Door area	66
G.11	Efficiency control of the discharge system	66
G.12	Condensate drip collector	66
G.13	Food probe	66
G.14	Other surfaces	67
G.15	Periods of non-use	67
G.16	Boiler maintenance	67
G.17	Replacing wear and tear components	67
G.18	Repair and extraordinary maintenance	67
G.19	Maintenance intervals	67
H	TROUBLESHOOTING	68
H.1	Introduction	68
H.2	Error codes	68
H.3	Oven connectivity issues (depending on your SW version)	78
I	FURTHER INFORMATION	78
I.1	Ergonomic features	78
I.1.1	Certification	78
I.1.2	General recommendations	78



---

## A WARNING AND SAFETY INFORMATION

---

### A.1 General information

To ensure safe use of the appliance and a proper understanding of the manual it is necessary to be familiar with the terms and typographical conventions used in the documentation. The following symbols are used in the manual to indicate and identify the various types of hazards:



#### **WARNING**

Danger for the health and safety of operators.



#### **WARNING**

Danger of electrocution - dangerous voltage.



#### **CAUTION**

Risk of damage to the appliance or the product.



#### **IMPORTANT**

Important instructions or information on the product



Equipotentiality



Read the instructions before using the appliance



Clarifications and explanations



#### **WARNING**

**Improper installation, adjustment, alteration, service or maintenance can cause property damage, injury or death. Read the installation, operating and maintenance instructions thoroughly before installing or servicing this equipment.**

#### **FOR YOUR SAFETY**

**Do not store or use gasoline or other flammable materials, vapours and liquids in the vicinity of this or any other appliance.**



#### **IMPORTANT**

After installation put in a prominent location suitable instructions to be followed in the event gas is smelt. This information shall be obtained by consulting the local gas supplier.





- Only specialised personnel are authorised to operate on the appliance.
- This appliance is to be intended for commercial and collective use, for example in kitchens of restaurants, canteens, hospitals and in commercial enterprises such as bakeries,

butcheries, etc., not for continuous mass production of food. Any other use is deemed improper.

- This appliance must not be used by minors and adults with limited physical, sensory or mental abilities or without adequate experience and knowledge regarding its use.
- Do not store explosive substances, such as pressurized containers with flammable propellant, in this appliance.
- Refer to the data given on the appliance's data plate for relations with the Manufacturer (e.g. when ordering spare parts, etc.).
- When scrapping the appliance, the marking must be destroyed.
- Save these instructions carefully for further consultation by the various operators.

## A.2 Personal protection equipment

Summary table of the Personal Protection Equipment (PPE) to be used during the various stages of the appliance's service life.

Stage	Protective garments 	Safety footwear 	Gloves 	Glasses 	Safety helmet 
Transport	—	●	○	—	○
Handling	—	●	○	—	—
Unpacking	—	●	○	—	—
Installation	—	●	● <sup>1</sup>	—	—
Normal use	●	●	● <sup>2</sup>	—	—
Adjustments	○	●	—	—	—
Routine cleaning	○	●	● <sup>1-3</sup>	○	—
Extraordinary cleaning	○	●	● <sup>1-3</sup>	○	—
Maintenance	○	●	○	—	—
Dismantling	○	●	○	○	—
Scrapping	○	●	○	○	—
<b>Key:</b>					
●	<b>PPE REQUIRED</b>				
○	<b>PPE AVAILABLE OR TO BE USED IF NECESSARY</b>				
—	<b>PPE NOT REQUIRED</b>				

1. During these operations, gloves must be cut-resistant. Failure to use the personal protection equipment by operators, specialized personnel or users can involve exposure to damage to health (depending on the model).

2. During these operations, gloves must be heatproof to protect hands from contact with hot food or hot parts of the appliance and/or when removing hot items from it. Failure to use the personal protection equipment by operators, specialised personnel or users can involve exposure to chemical risk and cause possible damage to health (depending on the model).

3. During these operations, gloves must be suitable for contact with chemical substances used (refer to the safety data sheet of the substances used for information regarding the required PPE). Failure to use the personal

protection equipment by operators, specialized personnel or users can involve exposure to chemical risk and cause possible damage to health (depending on the model).

### A.3 General safety

- The appliances are provided with electric and/or mechanical safety devices for protecting workers and the appliance itself.
- Never operate the appliance, removing, modifying or tampering with the guards, protection or safety devices.
- Do not make any modifications to the parts supplied with the appliance.
- Several illustrations in the manual show the appliance, or parts of it, without guards or with guards removed. This is purely for explanatory purposes. Do not use the appliance without the guards or with the protection devices deactivated.

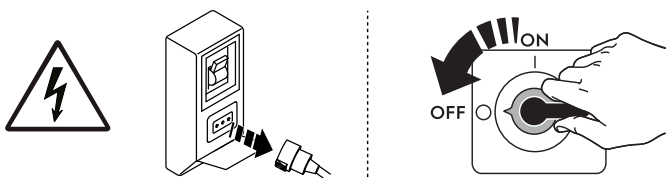

Disconnect the appliance from the power supply before carrying out any installation, assembly, cleaning or maintenance procedure.

- Do not remove, tamper with or make illegible the marking and safety, danger and instruction signs and labels on the appliance.
- Before servicing, disconnect the electrical service and place a red tag at the disconnect switch to indicate work is being done on that circuit.
- The A-weighted emission sound pressure level does not exceed 70 dB(A).
- Turn the appliance off in case of fault or poor operation.
- Do not use products (even if diluted) containing chlorine (sodium hypochlorite, hydrochloric or muriatic acid, etc.) to clean the appliance or the floor under it.
- Carefully avoid exposure of the equipment to ozone - do not use ozonizers in the rooms where the equipment is installed.
- Do not spray aerosols in the vicinity of this appliance while it is in operation.
- Do not place flammable liquids (e.g. spirits) inside the appliance during operation.
- Never check for leaks with an open flame.
- Install the appliance under conditions of adequate ventilation in order to provide a suitable air change per hour. Make sure that the ventilation system, whatever it is, always remains operational and efficient for the entire period of time during which the equipment is operating.

The appliance must be installed under ventilation hood only.

- Improper ventilation of the oven can be hazardous to the health of the operator; and will result in operational problems, unsatisfactory cooking results, and possible damage to the equipment. Damage sustained as a direct result of improper ventilation OF THE OVEN will not be covered by the Manufacturer's warranty.
- Do not obstruct the flow of combustion and ventilation air.
- The following operations have to be carried out by specialised authorised personnel or Customer Care Service provided with all the appropriate personal protection equipment (A.2 *Personal protection equipment*), tools, utensils and ancillary means, who can ask the manufacturer to supply a servicing manual:
  - Installation and assembly;
  - Positioning;

- Electrical connection;
- Appliance cleaning, repair and extraordinary maintenance;
- Appliance disposal;
- Work on electrical equipment;





#### A.4 Protection devices installed on the appliance

##### Guards

The appliance has:

- fixed guards (e.g. casings, covers, side panels, etc.), fixed to the appliance and/or frame with screws or quick-release connectors that can only be removed or opened with tools; therefore the user must not remove or tamper with such devices. The Manufacturer declines any liability for damage due to tampering or their non-use;
- interlocked movable guards (door) for access inside the appliance;
- appliance electrical equipment access panels or doors, made from hinged panels openable with tools. The panel or the door must not be opened when the appliance is connected to the power supply.

#### A.5 Safety signs to be placed on the appliance or near its area

Prohibition	Meaning
	do not remove the safety devices
	do not use water to extinguish fires (placed on electrical parts)
	Keep the area around the appliance clear and free from combustible materials. Do not keep flammable materials in the vicinity of the appliance
Danger	Meaning
	caution hot surface
	danger of electrocution (shown on electrical parts with indication of voltage)

#### A.6 Reasonably foreseeable improper use

Improper use is any use different from that specified in this manual. During appliance operation, other types of work or activities deemed improper and that in general can involve risks for the safety of operators and damage to the appliance are not allowed. Reasonably foreseeable improper use includes:

- lack of appliance maintenance, cleaning and periodical checks;
- structural changes or modifications to the operating logic;

- tampering with the guards or safety devices;
- failure to use personal protection equipment by operators, specialised personnel and maintenance personnel;
- failure to use suitable accessories (e.g. use of unsuitable equipment or ladders);
- keeping combustible or flammable materials, or in any case materials not compatible with or pertinent to the work, near the appliance;
- wrong appliance installation;
- placing in the appliance any objects or things not compatible with its use, or that can damage the appliance, cause injury or pollute the environment;
- climbing on the appliance;
- non-compliance with the requirements for correct appliance use;
- other actions that give rise to risks not eliminable by the Manufacturer.

## A.7 Residual risks

The appliance has several risks that were not completely eliminated from a design standpoint or with the installation of adequate protection devices. Nevertheless, through this manual the Manufacturer has taken steps to inform operators of such risks, carefully indicating the personal protection equipment to be used by them. In order to reduce the risks, provide for sufficient spaces while installing the unit.

To preserve these conditions, the areas around the appliance must always be:

- kept free of obstacles (e.g. ladders, tools, containers, boxes, etc.);
- clean and dry;
- well lit.

For the Customer's complete information, the residual risks remaining on the appliance are indicated below: such actions are deemed improper and therefore strictly forbidden.

<b>Residual risk</b>	<b>Description of hazardous situation</b>
Slipping or falling	The operator can slip due to water, any liquid or dirt on the floor
Burns/abrasions (e.g. heating elements, cold pan, cooling circuit plates and pipes)	The operator deliberately or unintentionally touches some components inside the appliance without using protective gloves.
Electrocution	Contact with live parts during maintenance operations carried out with the electrical panel powered
Falling from above	The operator intervenes on the appliance using unsuitable systems to access the upper part (e.g. rung ladders, or climbs on it)
Crushing or injury	The specialised personnel may not correctly fix the control panel when accessing the technical compartment. The panel could close suddenly.
Tipping of loads	When handling the appliance or the packing containing it, using unsuitable lifting systems or accessories or with the unbalanced load

<b>Residual risk</b>	<b>Description of hazardous situation</b>
Chemical	Contact with chemical substances (e.g. detergent, rinse aid, scale remover, etc.) without taking adequate safety precautions. Therefore always refer to the safety cards and labels on the products used.
Sudden closure	The operator for normal appliance use could suddenly and deliberately close the lid/door/oven door (if present, depending on the appliance type).

## **A.8 Appliance cleaning**



### **IMPORTANT**

In order to maintain the appliance performance and safeness, the appliance shall be maintained and cleaned.

- Do not touch the appliance with wet hands or feet or when barefoot.
- Use a ladder with suitable protection for work on appliances with high accessibility.
- Put the appliance in safe conditions before starting any cleaning operation.
- Respect the requirements for the various routine and extraordinary maintenance operations. Non-compliance with the instructions can create risks for personnel.
- Do not spray water or use water jets, steam cleaner or high pressure cleaner.

## **A.9 Preventive Maintenance**

In order to ensure the safety and performance of your equipment, it is recommended that service is undertaken by Electrolux Professional authorised engineers every 12 months, in accordance with Electrolux Professional Service Manuals. Please contact your local Electrolux Professional Service Centre for further details.

## **A.10 Parts and accessories**

Use only original accessories and/or spare parts. Failure to use original accessories and/or spare parts will invalidate the original manufacturer warranty and may render the appliance not compliant with the safety standard.

## **A.11 Precautions for use and maintenance**

- Risks mainly of a mechanical, thermal and electrical nature exist in the appliance. Where possible the risks have been neutralised:
  - directly, by means of adequate design solutions.
  - indirectly by using guards, protection and safety devices.
- Any anomalous situations are signalled on the control panel display.
- During maintenance several risks remain, as these could not be eliminated, and must be neutralised by adopting specific measures and precautions.
- Do not carry out any checking, cleaning, repair or maintenance operations on moving parts. Workers must be informed of this prohibition by means of clearly visible signs.
- Make sure to periodically check correct operation of all the safety devices and the insulation of electrical cables, which must be replaced if damaged.

In case of a significant anomaly (e.g. short circuits, wires coming out of the terminal block, motor breakdowns, worn electrical cable sheathing, etc.) the operator for normal appliance use must:

- immediately deactivate the appliance and disconnect all the supplies (electricity, gas, water).

Before carrying out any operation on the appliance, always consult the manual which gives the correct procedures and contains important information on safety.

## A.12 Appliance maintenance

- The inspection and maintenance intervals depend on the actual appliance operating conditions and ambient conditions (presence of dust, damp, etc.), therefore precise time intervals cannot be given. In any case, careful and periodical appliance maintenance is advisable in order to minimise service interruptions.
- It is advisable to stipulate a preventive and scheduled maintenance contract with the Customer Care Service.
- Put the appliance in safe conditions before starting any maintenance operation.
- To guarantee appliance efficiency and correct operation, periodical maintenance must be carried out according to the instructions given in the manual.

---

## B WARRANTY

### B.1 Warranty terms and exclusions

If the purchase of this product includes warranty coverage, warranty is provided in line with local regulations and subject to the product being installed and used for the purposes as designed, and as described within the appropriate equipment documentation.

Warranty will be applicable where the customer has used only genuine spare parts and has performed maintenance in accordance with Electrolux Professional user and maintenance documentation made available in paper or electronic format.

Electrolux Professional strongly recommends using Electrolux Professional approved cleaning, rinse and descaling agents to obtain optimal results and maintain product efficiency over time.

The Electrolux Professional warranty does not cover:

- service trips cost to deliver and pick up the product;
- installation;
- training on how to use/operate;
- replacement (and/or supply) of wear and tear parts unless resulting from defects in materials or workmanship reported within one (1) week from the failure;
- correction of external wiring;
- correction of unauthorized repairs as well as any damages, failures and inefficiencies caused by and/or resulting from:
  - insufficient and/or abnormal capacity of the electrical systems (current/voltage/frequency, including spikes and/or outages);
  - inadequate or interrupted water supply, steam, air, gas (including impurities and/or other that does not comply with the technical requirements for each appliance);
  - plumbing parts, components or consumable cleaning products that are not approved by the manufacturer;

- customer's negligence, misuse, abuse and/or non-compliance with the use and care instructions detailed within the appropriate equipment documentation;
- improper or poor: installation, repair, maintenance (including tampering, modifications and repairs carried out by third parties not authorized) and modification of safety systems;
- Use of non-original components (e.g.: consumables, wear and tear, or spare parts);
- environment conditions provoking thermal (e.g. overheating/freezing) or chemical (e.g. corrosion/oxidation) stress;
- foreign objects placed in- or connected to- the product;
- accidents or force majeure;
- transportation and handling, including scratches, dents, chips, and/or other damage to the finish of the product, unless such damage results from defects in materials or workmanship and is reported within one (1) week of delivery unless otherwise agreed;
- product with original serial numbers that have been removed, altered or cannot be readily determined;
- replacement of light bulbs, filters or any consumable parts;
- any accessories and software not approved or specified by Electrolux Professional.

**Electrolux Professional warranty will be void and manufacturer shall have no liability related thereto in case of any modification of the product or related hardware/software/programming.**

Warranty does not include scheduled maintenance activities (including the parts required for it) or the supply of cleaning agents unless specifically covered within any local agreement, subject to local terms and conditions.

Check on Electrolux Professional website the list of authorized customer care.

## C GENERAL INFORMATION



### WARNING

Refer to “*WARNING and Safety Information*”.

#### C.1 Introduction

This manual contains information relevant to various appliances. The product images in this guide are only an example.

The drawings and diagrams given in the manual are not in scale. They supplement the written information with an outline, but are not intended to be a detailed representation of the appliance supplied.

The numerical values given on the appliance installation diagrams refer to measurements in millimeters and/or inches.

#### C.2 Intended use and restrictions

This appliance is designed for cooking food. It is intended for collective use.

Any other use is deemed improper.



#### NOTE!

The manufacturer declines any liability for improper use of the product.

#### C.3 Testing and inspection

Our appliances have been designed and optimized, with laboratory testing, in order to obtain high performance and efficiency.



#### IMPORTANT

For 20 grids models only: the oven shall be used with the supplied trolley or with the appropriate ones listed in the accessory catalogue.

The appliance is shipped ready for use.

Passing of the tests (visual inspection - gas/electrical test - functional test) is guaranteed and certified by the specific enclosures.

#### C.4 Copyright

This manual is intended solely for consultation by the operator and can only be given to third parties with the permission of Electrolux Professional company.

#### C.5 Keeping the manual

The manual must be carefully kept for the entire life of the appliance, until scrapping. The manual must stay with the appliance in case of transfer, sale, hire, granting of use or leasing.

#### C.6 Recipients of the manual

This manual is intended for:

- the employer of appliance users and the workplace manager;
- operators for normal appliance use;
- specialised personnel - Customer Care service (see service manual).

#### C.7 Definitions

Listed below are the definitions of the main terms used in the manual. It is advisable to read them carefully before use.

Operator	appliance installation, adjustment, use, maintenance, cleaning, repair and transport personnel.
Manufacturer	Electrolux Professional SpA or any other service centre authorised by Electrolux Professional SpA.
Operator for normal appliance use	an operator who has been informed and trained regarding the tasks and hazards involved in normal appliance use.
Customer Care service or specialised personnel	an operator instructed/trained by the Manufacturer and who, based on his professional and specific training, experience and knowledge of the accident-prevention regulations, is able to appraise the operations to be carried out on the appliance and recognise and prevent any risks. His professionalism covers the mechanical, electrotechnical and electronics fields etc.
Danger	source of possible injury or harm to health.
Hazardous situation	any situation where an operator is exposed to one or more hazards.
Risk	a combination of probabilities and risks of injury or harm to health in a hazardous situation.
Protection devices	safety measures consisting of the use of specific technical means (guards and safety devices) for protecting operators against risks.
Guard	an element of a appliance used in a specific way to provide protection by means of a physical barrier.
Safety device	a device (other than a guard) that eliminates or reduces the risk; it can be used alone or in combination with a guard.
Customer	the person who purchased the appliance and/or who manages and uses it (e. g. company, entrepreneur, firm).
Electrocution	an accidental discharge of electric current on a human body.

#### C.8 Responsibility

**The Manufacturer declines any liability for damage and malfunctioning caused by:**

- non-compliance with the instructions contained in this manual;
- repairs not carried out in a workmanlike fashion, and replacements with parts different from those specified in the spare parts catalogue (the fitting and use of non-original spare parts and accessories can negatively affect appliance operation and invalidates the original manufacturer warranty);
- operations carried out by non-specialised personnel;
- unauthorized modifications or operations;
- missing, lack or inadequate maintenance;
- improper appliance use;
- unforeseeable extraordinary events;
- use of the appliance by uninformed and / or untrained personnel;
- non-application of the current provisions in the country of use, concerning safety, hygiene and health in the workplace.



The Manufacturer declines any liability for damage caused by arbitrary modifications and conversions carried out by the user or the Customer.

The employer, workplace manager or service technician are responsible for identifying and choosing adequate and suitable personal protection equipment to be worn by operators, in compliance with regulations in force in the country of use.

The Manufacturer declines any liability for inaccuracies contained in the manual, if due to printing or translation errors.

Any supplements to the installation, use and maintenance manual the Customer receives from the Manufacturer will form an integral part of the manual and therefore must be kept together with it.

## D NORMAL MACHINE USE

### D.1 Characteristics of personnel enabled to operate on the appliance

The Customer must make sure the personnel for normal appliance use are adequately trained and skilled in their duties.

The operator must:

- read and understand the manual;
- receive adequate training and instruction for their duties in order to operate safely;
- receive specific training for correct appliance use.



#### IMPORTANT

The Customer must make sure his personnel have understood the instructions received and in particular those regarding work hygiene and safety in use of the appliance.

### D.2 Basic requirements for appliance use

- Knowledge of the technology and specific experience in operating the appliance.
- Adequate general basic education and technical knowledge for reading and understanding the contents of the manual, including correct interpretation of the drawings, signs and pictograms.
- Sufficient technical knowledge for safely performing his duties as specified in the manual.
- Knowledge of the regulations on work hygiene and safety.

## E PRODUCT DESCRIPTION

### E.1 Use – Introduction

The instructions and information given in this manual are important for correct and optimum oven use. If required, further details regarding its characteristics and cooking performance can be obtained from the dealer.

- To avoid obstructing the fume and steam discharge pipes, do not place pans or utensils of any kind on the oven.
- Do not place objects (e.g. pans) under the bottom of the oven, so as not to obstruct any cooling air inlet or outlet holes.



#### IMPORTANT

In 20 Grids models run the cleaning cycles only with trolley inside the oven. It helps the sealing in closing the bottom openings between the cavity and the door.

- Do not salt food inside the oven, in particular with humid cycles.
- Do not place flammable liquids (e.g. spirits) inside the oven during operation.



#### IMPORTANT

After the installation of 6, 10 and 20 grids ovens (stacking installation included) is carried out, check at which height the upper trays are placed in the oven. If required, place the following sticker (supplied) on the front of the oven and **at a height of 1,60 m or higher above the floor.**



#### CAUTION

To avoid burns, do not use recipients containing liquids (or products that become liquid with cooking) in shelves positioned at levels higher than 1,6 m above the floor. This is to prevent spilling during handling.

### Food loading on oven

No. of grids		MODELS					
		6 GN 1/1	6 GN 2/1	10 GN 1/1	10 GN 2/1	20 GN 1/1	20 GN 2/1
Maximum oven load	Kg	30	60	50	100	100	200
Maximum pan/tray load	Kg	15	30	15	30	15	30

### E.2 Notice

For 120v. gas versions, Electrolux Professional does not recommend the use of a GFCI outlet. If a GFCI outlet is required by code, a commercial GFCI with a rating of 20 mV must be used.

## E.3 Appliance overview

6 - 10 GN model

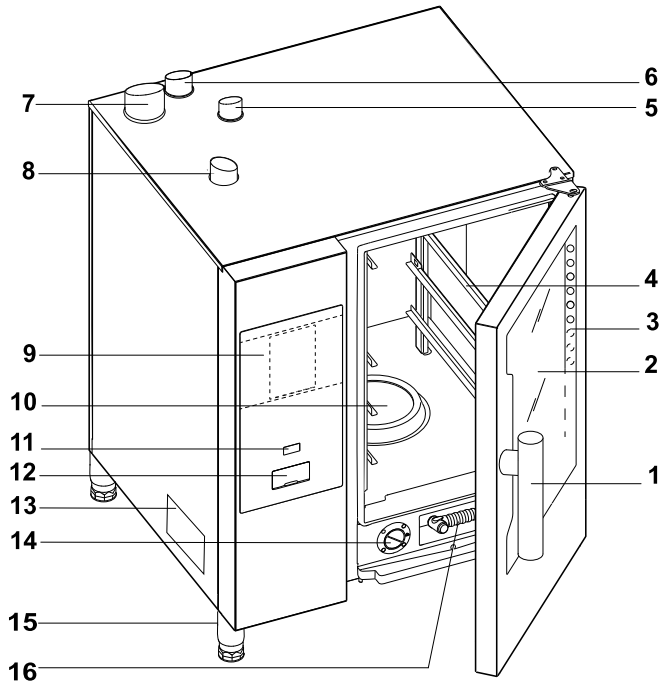

20 GN model

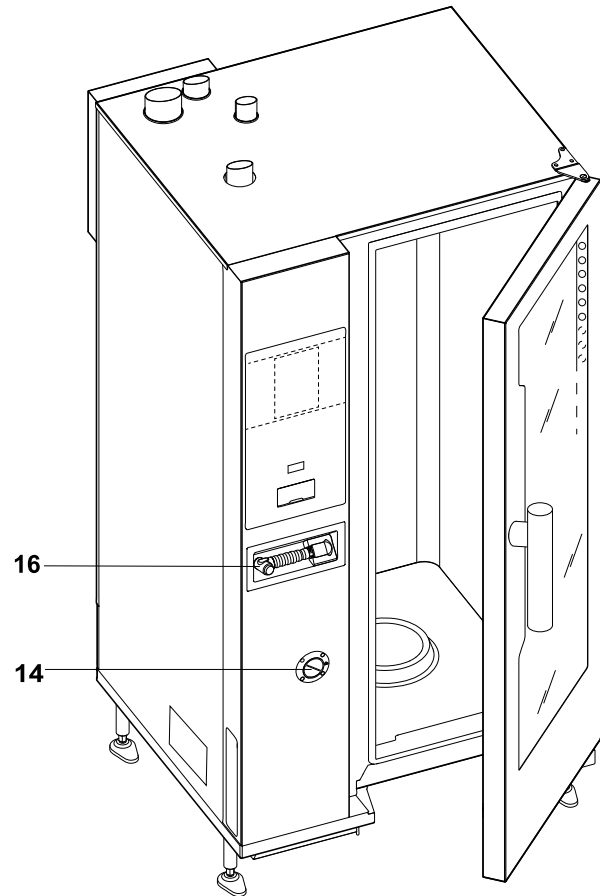

1. Door handle (shape depending on the model)
2. Glass door
3. Led bar for lighting cavity
4. Grids support
5. Exhaust gas cavity heat exchanger (all gas models)
6. Steam discharge (electric and gas models)
7. Exhausting gas from steam generator (gas models with boiler)
8. Air inlets (electric and gas models)
9. Control panel

10. Cavity filter – housing for detergent tabs (cavity washing)
11. ON/OFF button
12. USB pendrive position
13. Dataplate
14. Descaling/rinse agent drawer
15. Feet
16. Hand spray cleaning unit, if present in your model



**NOTE!**

The hand spray only works if the oven is switched on.

## E.4 Opening and closing the oven door

Below the instructions for closing and opening the oven door, model by model.

### 6 GN and 10 GN Model

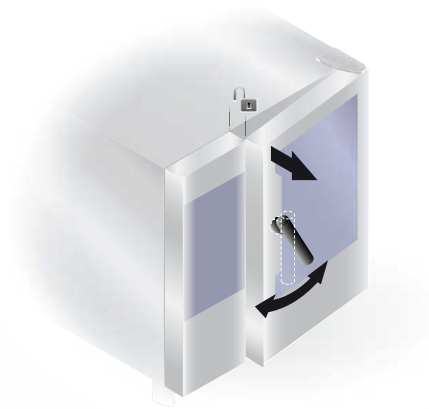

1. Turn the door handle clockwise or counterclockwise all the way to fully open the oven door. The cooking cycle is stopped, if in progress.
2. To close the door press it against the oven enough to lock it.

## 20 GN Model



1. Rotate the handle by 90°C counterclockwise to open the door completely. The cooking programme is stopped, if in progress.
2. For closing rotate the handle by 90°C counterclockwise until it stops and bring the door against the oven.
3. Keeping the door pressed against the oven, rotate the handle back in its vertical position to complete its locking.

## E.5 Control panel

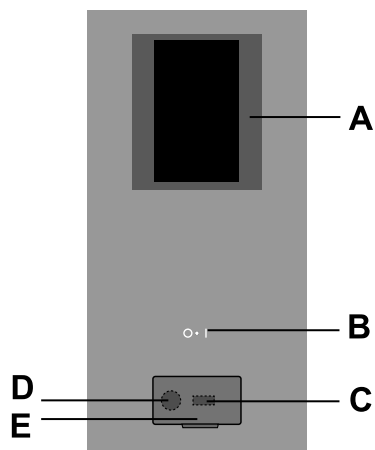

- A. Display – Touch screen
- B. ON/OFF button
- C. USB pendrive in/out
- D. Connection for accessory
- E. Openable flap

## F OPERATING

### F.1 SWITCH THE OVEN ON

Press the “I” side of the button “O – I” to switch the oven on.  
Press the “O” side of the same button to switch the oven off.



#### IMPORTANT

**For gas models only:** wait 5 minutes before relighting.



#### NOTE!

After switching off the oven, the cooling fan can still remain active for safety reasons.

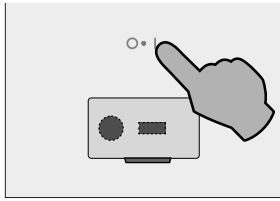

The display illuminates, loads the software (it will be visible the SW version) and, after a while, shows by default the following screen, in MANUAL mode.

### Models with boiler

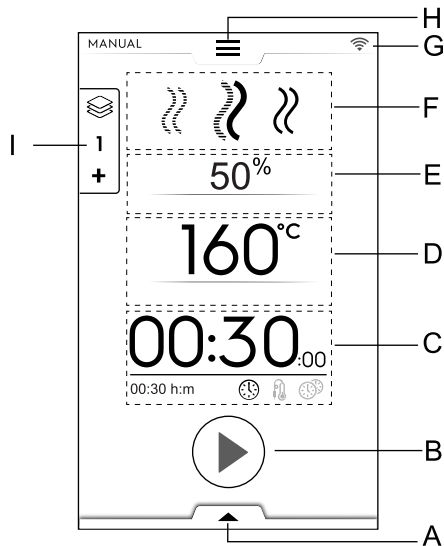

- A. Lower drawer – Additional functions (utilities)
- B. Start button area
- C. Time / Food Probe / MultiTimer area
- D. Cavity temperature area
- E. Cavity humidification area
- F. Cooking cycle(s) area
- G. Connectivity area
- H. Upper drawer – Main menu
- I. Multiphase Drawer

### Models boilerless

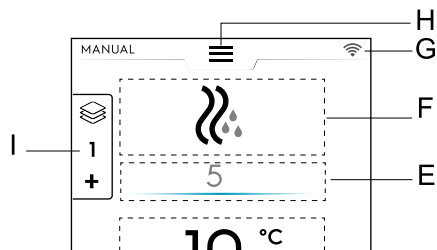

## F.2 MAIN MENU

The oven allows cooking in different cooking modes according to your food type and requirements, to create and store recipes, programs, to recall them, to plan cooking activities or to carry out an automatic cleaning.

The main menu of the start page is composed of various modes corresponding to the different functions of the oven.

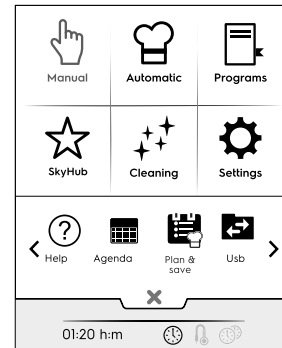

### NOTE!

To navigate inside the main menu, always touch the upper drawer.

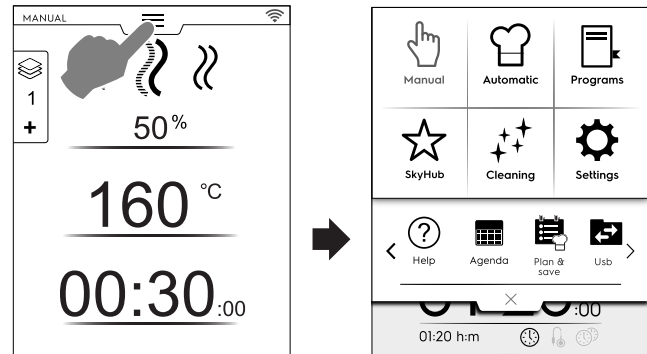

Touch the required icon in the main menu to access inside the different modes.

### Cooking modes



#### Manual Mode

“Manual” mode customizes the cooking cycles choosing among Convention, Combi and Steam cycles and setting the humidity level, time and temperature (see F.6 *MANUAL MODE* chapter).



#### Automatic Mode

“Automatic” mode allows to cook food in a quick and easy way, just choosing the required food and the way to cook it.

The set parameters enable you to get excellent and repeatable cooking results whenever you want (see F.7 *AUTOMATIC MODE* chapter).



#### Programs mode

“Programs” mode recalls the recipes previously saved and restores quickly parameters and settings of each cooking cycle avoiding the need to assign them again (see F.8 *PROGRAMS MODE* chapter).



#### Homepage Mode (SkyHub/SoloMio)

“Homepage” mode helps to store your recipes managing them inside a customized area (see F.8 *PROGRAMS MODE* chapter).

### Other modes



#### Cleaning mode

With “Cleaning mode” it is possible to carry out the cleaning of the cavity and the descaling cycle of the boiler, if available in your model.



### Settings mode

“Settings” mode allows to customize the oven functions and options for a better use.

## < SCROLLING AREA Options >



Help

This function provides QR codes in order to display the user manual on your device (smartphone, tablet or laptop). See F.10 *HELP MODE* chapter).



AGENDA (MyPlanner/Calendar)

This function allows to plan oven activities, cooking or cleaning programs or to set reminders, according to your schedule (see F.11 *AGENDA MODE (CALENDAR – MY PLANNER)* chapter).



PLAN-N-SAVE/COOKING OPTIMIZER

This function allows you to optimise consecutive cooking processes in order to reduce energy and water consumption of the transition phases (see F.13 *PLAN&SAVE/COOKING OPTIMIZER MODE* chapter).



SKYDUO/MATCH (optional)



#### NOTE!

Available as option only on specific models combined with the appropriate accessory.

This function can be activated on demand and works combined with connectivity devices installed by specialised personnel. It allows to connect the oven to a blast chiller (see F.14 *SKYDUO/MATCH MODE (depending on your model - optional)* chapter).



USB

The USB mode allows to upload/download, from or into the appliance, programs or other data by means of the USB pendrive. See F.12 *USB MODE* chapter.

## F.3 OVEN CONNECTIVITY

If the oven is connected remotely to Cloud, the display will show different icons that indicate the connection status.

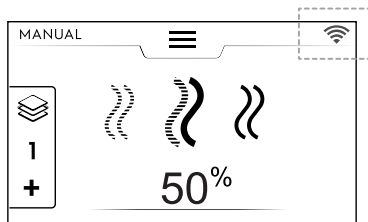

### Connection status icons



Oven connected to cloud via Wifi. The Wifi signal is **good**.



Oven connected to cloud via Wifi. The Wifi signal is **medium**.



Oven connected to cloud via Wifi. The Wifi signal is **poor**.



Oven connected to cloud via Ethernet.

For connection issues, refer to H.3 *Oven connectivity issues (depending on your SW version)* paragraph.

## F.4 TOUCH SCREEN COMMANDS / INFO AND DISPLAY MESSAGES

The icons of this area allow the interaction with the oven or just give information about the oven status or the accessories connected.

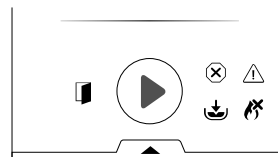

### Touch screen commands



Touch this icon to confirm and/or save the selection



Touch this icon to discard the selection or close a pop-up window



Touch this icon to come back to the previous menu



Touch this icon to start a cycle



Hold down this button for a few seconds to stop a running cycle



Touch this icons to move between the pages (horizontal scrolling) or increase/decrease a value



Touch this icons to move between the pages (vertical scrolling)

### Signalling information



Door open warning signalling icon

The icon appears when the door is open or not properly closed



Fan speed level



Boiler in filling or heating phase

**Not available in boilerless models**



Boiler temperature too high

**Not available in boilerless models**



In gas models only:  
Gas burner<sup>1</sup> blocked.  
To reset the boiler ignition touch the green flame icon .



Water injection



Reduced power



Blocking alarm

### Display messages



Warnings

A pop up window appears on the display to show the warning in progress.



Alarms signalling icon

A pop up message indicating the alarm in progress appears on the display. This icon remains visible until the problem is solved. For the alarm list (number and code), see H.2 *Error codes* paragraph.



Information

An information message communicates if something is wrong, if a procedure is completed or should be repeated and so on.

## F.5 DRAWERS AREA

The drawers are an expansion located inside several environments of the menu and contains options and functions.

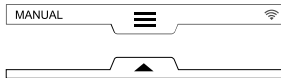

### UPPER DRAWER

- This drawer allows to navigate into the main menu.
  - Upper drawer opening:

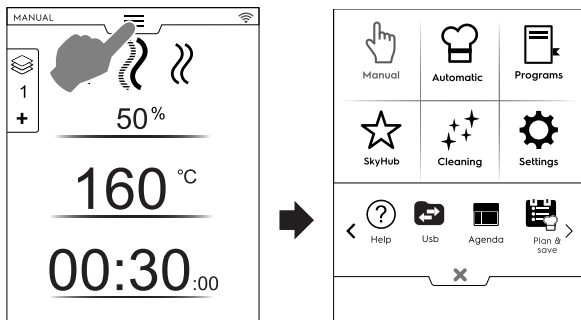

- Moving between pages:  
Touch the arrows in the scrolling area;

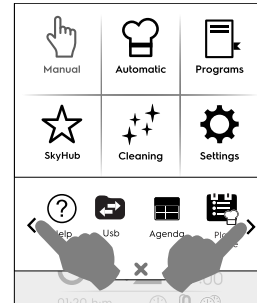

- Upper drawer closing:



Touch **X** button to close the drawer.

### LOWER DRAWER

- This drawer allows to access to further options, accessories and advanced features.
  - Lower drawer opening:

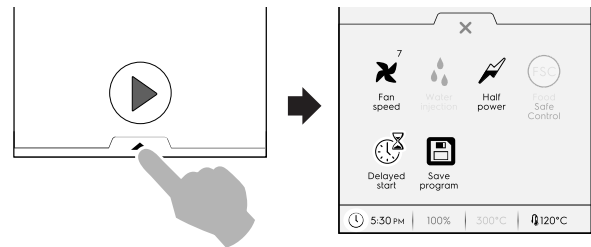

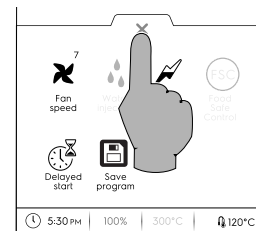

- Lower drawer closing



### LOWER DRAWER functions – Utilities

This drawer contains further settings, accessory management and advanced features. Its composition depends on the setting parameters and on the phase cycle.

#### Fan speed

- Touch this icon to set the speed of the fan from 1 to 7 levels.
- Touch **X** icon to close and enable the setting.
- To disable this function operate on  /  icons.

1. It can be the upper cavity burner or the bottom cavity burner or the boiler burner

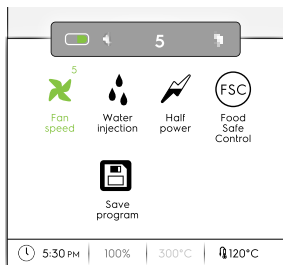

### Water injection into cavity (available only for the convection cooking cycle)

Touch this icon to increase the humidity level in the cavity at the beginning of the cooking phase.

- Set the duration of the water injection (from 10 seconds to 30 minutes).
- Touch **X** icon to close and enable the setting.
- To disable this function operate on / icons.

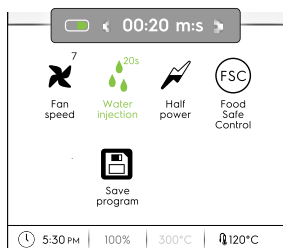

### Reduced power

Touch this icon to limit the power peak of the installed power. Available for every cooking cycle. When selected the icon becomes green.

### Food Service Control (FSC)

To enable this function see *Food Safe Control (FSC)* paragraph in F.17 *SETTINGS* chapter.

FSC enables the control of the microbiological safe condition of the food while cooking (see the paragraph *Food Safe Control (FSC)*)

- Touch this icon. A pop up message asks to select the level of risk between standard or high
- Set the required food icon to change the risk.

The corresponding icon on the lower drawer changes accordingly .

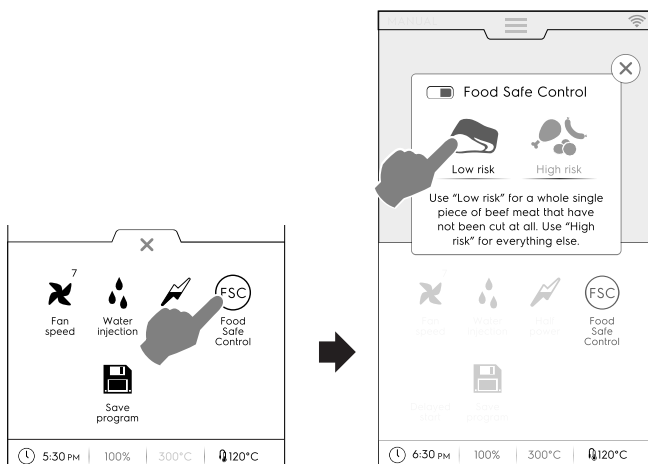

### Delayed start

With this option it will be possible to delay the start of a cycle at a more convenient time.

After having set the delayed start and touched the , the display shows the corresponding icon and the selected delay time. The appliance starts the countdown.

### Save program

Touch this icon to save and store customized cooking cycles. See *How to create and save a program* paragraph in F.8 *PROGRAMS MODE* chapter.

## F.6 MANUAL MODE

### F.6.1 MAIN PAGE

The manual mode displays the following **first page**:

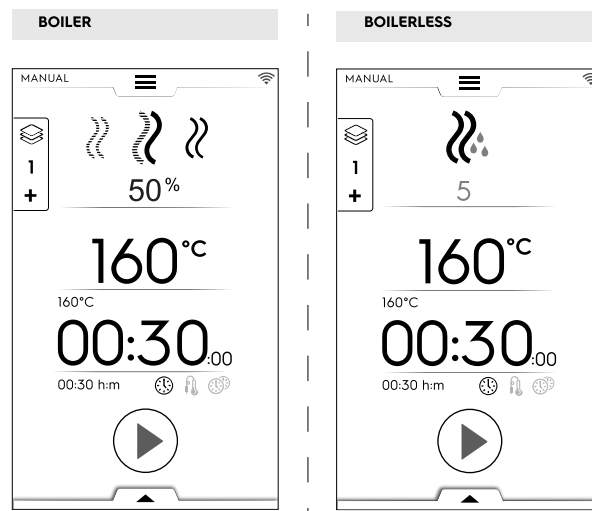

To display the home page with more detailed information, see F.17 *SETTINGS* chapter (Manual ⇒ General, ⇒ Show real and set values).

### F.6.2 COOKING CYCLES

#### Models with boiler

**CONVECTION Cycle**  
For roasting and gratinating;  
Maximum temperature up to 300 °C.

**COMBI Cycle**  
The steam generator and compartment heaters are used at the same time to keep foods tender;  
Maximum temperature up to 300 °C.

**STEAM Cycle**  
Ideal for boiling (operating temperature automatically fixed at 100°C);  
Low temperature steam for gentle cooking, vacuum packed foods and for defrosting (temperature from 25°C to 99°C);  
Superheated steam (temperature 101°C – 130°C).

## Models boilerless



### CONVECTION Cycle

Maximum temperature up to 300 °C.

For roasting and gratinating; Maximum temperature up to 300 °C.

## F.6.3 SETTING A COOKING CYCLE

1. Select a cycle, for example COMBI;

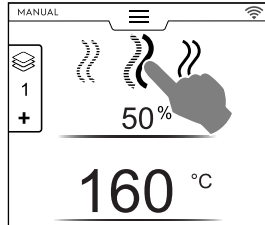

2. If it is necessary, set the required HUMIDITY;

- Touch the row of the humidity value;
- Enter the new value on the numeric keypad appearing on the display.

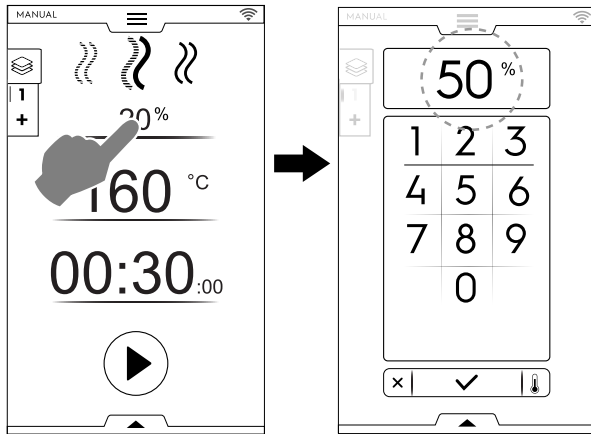

3. Set the required TEMPERATURE<sup>2</sup>

- Touch the row of the temperature value; enter the new value on the numeric keypad appearing on the display.

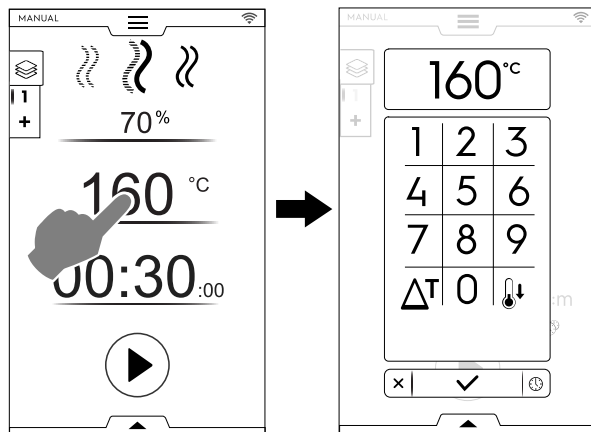

4. Set the duration TIME

- Touch the row of the time value; enter the new value on the numeric keypad.

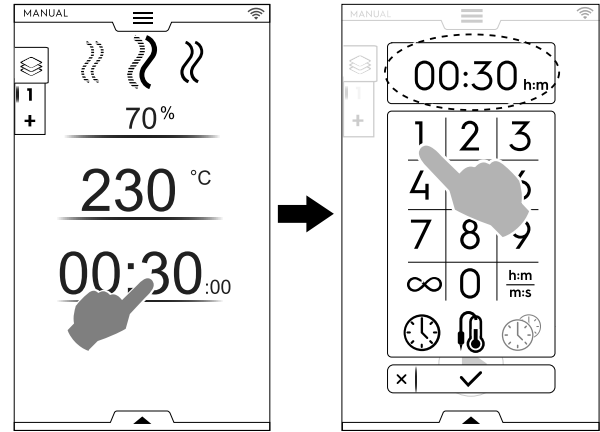

∞ Continuous cooking time

h:m  
m:s Displayed time

🔊 Food Probe

🕒 MultiTimer



### IMPORTANT

The numeric keypad allows to set further options of the cycle without returning back to the first page of Manual mode.

- Touch the button illustrated in the figure to access the setting of temperature and time options;

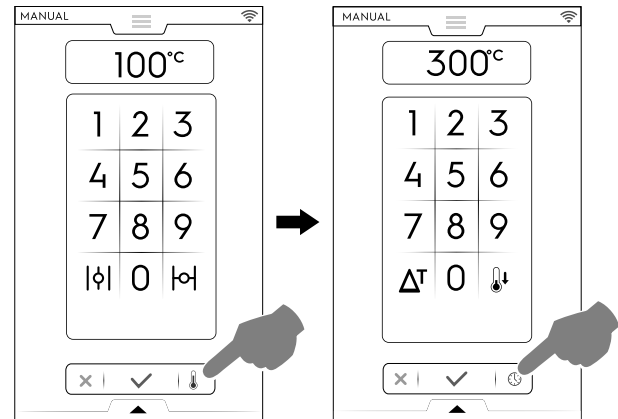

5. Touch button to start the set cooking cycle.

## F.6.4 DELAY START

The Delay start must be set setting before touching START button.

- A. Open the lower drawer and touch the corresponding icon ("A");

2. In continuous operation after 30 minutes the cavity temperature is limited to 260 C° for energy saving. It is automatically restored at set temperature when food is loaded.



- B. Set the starting time on the appearing keypad (“B”) and touch **X** to close it;

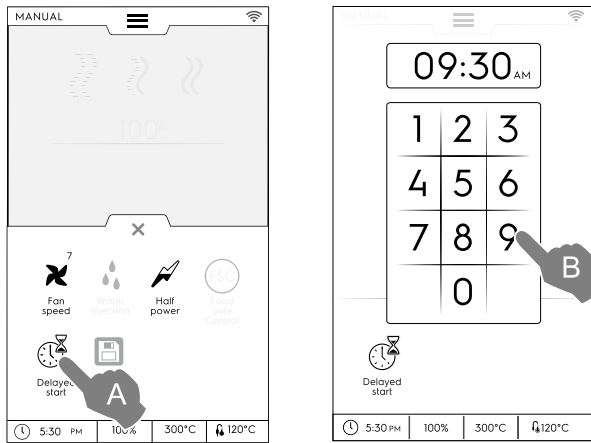

**NOTE!**

To cancel the delayed start, open the lower drawer again and touch the green delay start icon. It should change colour from green into white.

- A. The display shows the set cooking cycle with the delayed start. Touch the **▶** button to confirm it (“C”).

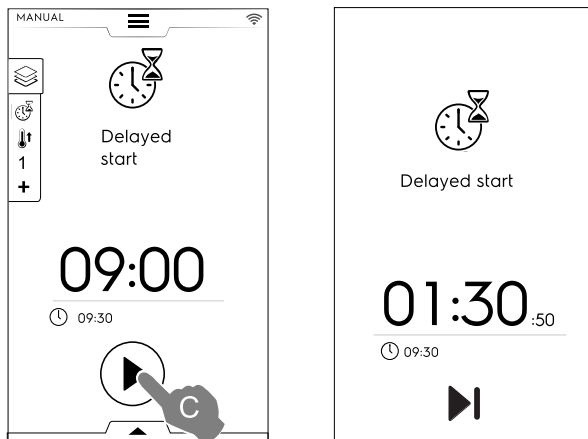

- If you want the oven to perform the preheating for the delayed cycle, see F.17 *SETTINGS* chapter (Manual ⇌ General, ⇌) and enable the feature “Delayed start preheating” (☑ / ☐). In this case the oven asks to perform the preparation phase (preheating) for the cycle at the set time.

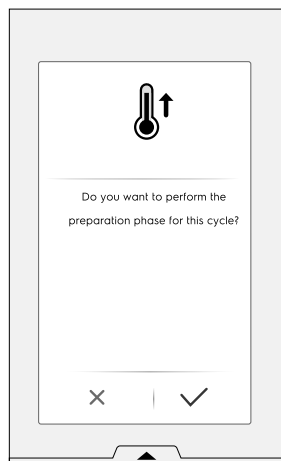

The appliance starts the countdown. The display shows the delay start icon, the remaining time and the set starting time.

It is still possible to skip the delay and start immediately the cycle. In this case the oven starts the preheating phase.

**F.6.5 START OPTIONS**

▶ **Auto Start**

Setting this option allows the cooking cycle to start by closing the door. The **START** button is not visible on the display.

To enable the Autostart in all modes see F.17 *SETTINGS* chapter (Autostart).



**IMPORTANT**

For regulatory requirements on gas appliances safety, we suggest you to enable the Auto Start option combined with the “Two touch” mode interface so as to avoid any accidental start of the cycle.

---- **Two Touch mode**

When the cycle starts with the closing of the door (Autostart), the “Two touch” mode forces the user to set and confirm the duration of the cycle and thus become aware of the cycle being set.

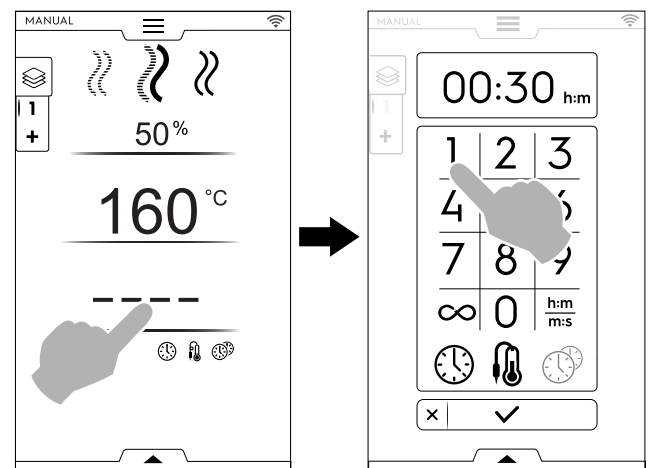

To enable the “Two Touch” mode contact an authorized technician.

6. The preheating (or precooling) phase starts. The preheating or precooling prepares the cavity temperature before the beginning of the selected cycle.

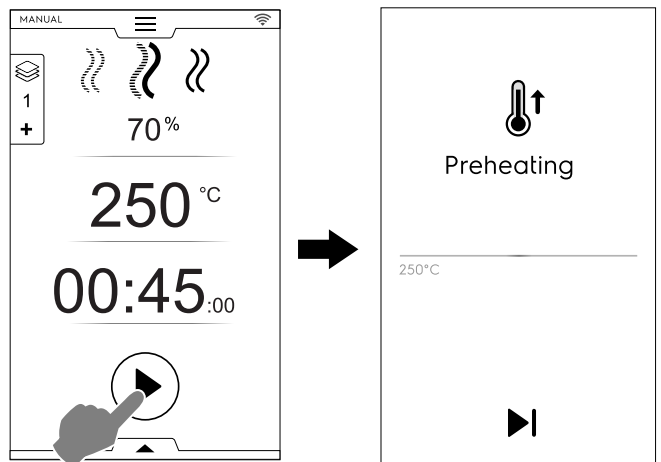

**NOTE!**

If the cavity temperature is too high a message asks for opening the door to facilitate its cooling down.

## ▶ Skip Preheating / Precooling

Touch the icon ▶ to skip this phase and go immediately to the main cycle.



**NOTE!**  
This phase can be enabled or disabled in F.17 **SETTINGS** chapter (Manual ⇒ General, ⇒ Cooking preheating).

- At the end of Preheating acoustic signals sound and the door light flashes.  
A pop-up window opens, showing the message that the cycle can start.
- If a **TIME CYCLE** is chosen: insert the food in the appliance and close the door to start the cycle;
- If the **PROBE CYCLE** is chosen: insert the food in the appliance, the food probe in the product and close the door to start the cycle;

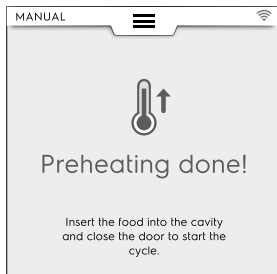

## ⏹ Stop cycle

Hold down the ⏹ button to stop the cycle.

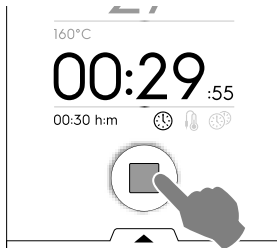

## F.6.6 END CYCLE

- At the end of the cycle some acoustic signals sounds. A pop-up window opens showing the summary of consumption, time cycle and utility used.

Touch ✓ button to close the pop-up window;

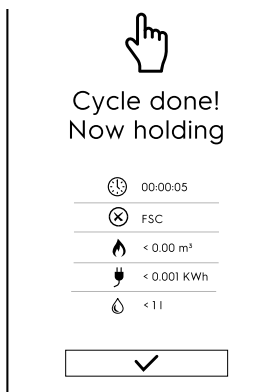

The appliance starts holding.

🕒 Time consumption in hours : minutes : seconds

✓ Utility used: FSC Food Safe Control  
The final check by FSC is successful.

✗ Utility used: FSC Food Safe Control  
The final check by FSC is unsuccessful.

🔥 Gas consumption in m<sup>3</sup>

🔌 Electric consumption in kWh

💧 Water consumption in litres

## F.6.7 TEMPERATURE OPTIONS

(for all cooking modes)

### ECO DELTA $\Delta T$

- This is an advanced cooking method, where the oven compartment temperature varies according to the core temperature of the food. The cavity temperature is automatically adjusted according to the temperature inside the food (**CORE PROBE**), maintaining a constant difference, "ECO-DELTA" between them, from start to end of cooking.

### Delta temperature

Values to be set:	from 5 to 120°C
-------------------	-----------------

This function enables cooking without harming the food with high temperatures; this ensures more gentle and more even cooking, with less weight loss.

The ECO-DELTA function is only possible with the core probe inserted.

- While setting the temperature, touch the icon  $\Delta T$ ;
- Enter the required delta value on the numeric keypad;  
Touch ✓ button to confirm;

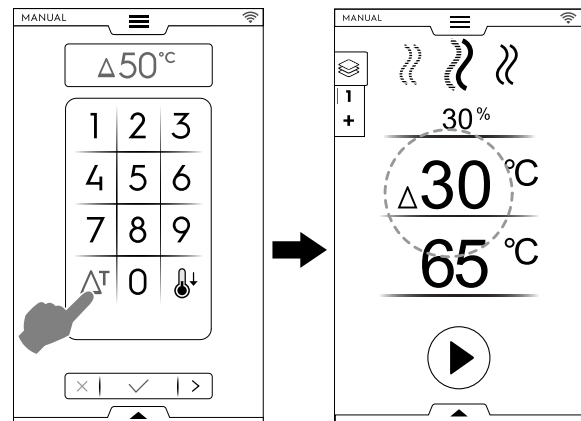

- Touch the probe icon 📍 and enter the required value;
- Insert the probe into the food (see the probe use at the paragraph *How to use a probe*).
- Close the door and press ▶ button.

**NOTE!**

To delete ECO-DELTA function touch the icon  $\Delta T$  again.

With ECODELTA on, the mode "Cooking Time" switches automatically to the "Core Probe" mode, that detects the inside temperature of the food (65°C).

This function is particularly suitable for cooking large pieces of food (at least 5 kg, e.g. whole turkey, leg of pork, etc.).

**COOLING DOWN**

- Fast cavity cooling useful for switching from one type of cooking to another at lower temperature; It enables fan rotation and automatic injection of water even with the door open. This option is not available if the cavity temperature is higher than 180°C.

1. Touch button;

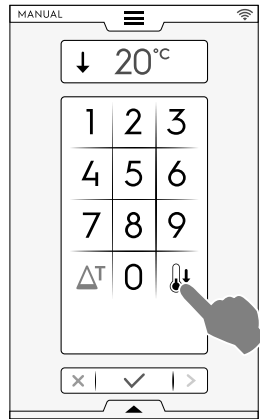

2. Enter the temperature value that the oven has to reach for the next cooking.
3. Touch button to confirm.

**F.6.8 HUMIDITY OPTION****STEAM cycle**

- The humidity value – 100°C is fixed and not adjustable.

**COMBI cycle – Humidity PERCENTAGE LEVEL**

01 % It allows to adjust the required humidity level in the cavity during cooking.

- Touch the humidity row. Enter the new value on the keypad (e.g. 50).
- The oven will reach and maintain the set humidity during the whole cooking cycle.

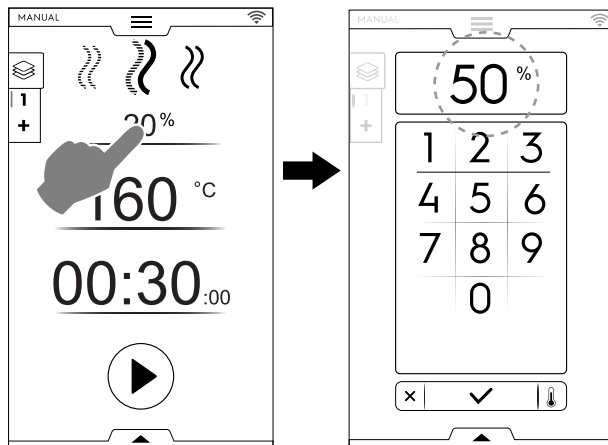
**CONVECTION cycle – VENT VALVE**

Vent valve CLOSED for high humidity cooking (Default setting)

**Models with boiler**

01 % Vent valve ADJUSTABLE for cooking with humidity adjustable from 1 to 99 %, allowing the removal of humidity when the set value is exceeded.

**Boilerless models only:**

Vent valve ADJUSTABLE

**NOTE!**

Regardless of the number entered, the values on the display will always be rounded to the nearest ten (10, 20, 30, 40... up to 100).

01 % – 100%

Entered values	Output values
From 0 to 4	0
From 5 to 14	10
From 15 to 24...	20...
From 85 to 94	90
From 95 to 100	100



Vent valve OPEN for very dry cooking allowing the removal of humidity when necessary. Max. temperature up to 300°C)

**Vent setting (only for CONVECTION cycle)**

- Touch VENT CLOSED option

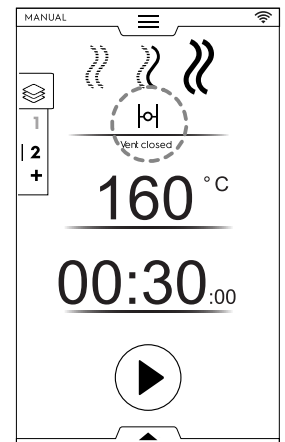
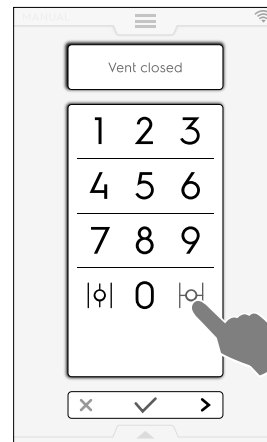

- Controlling HUMIDITY PERCENTAGE

Enter a value on the numeric keypad (for example 30). The vent is closed for the corresponding 30% humidity.

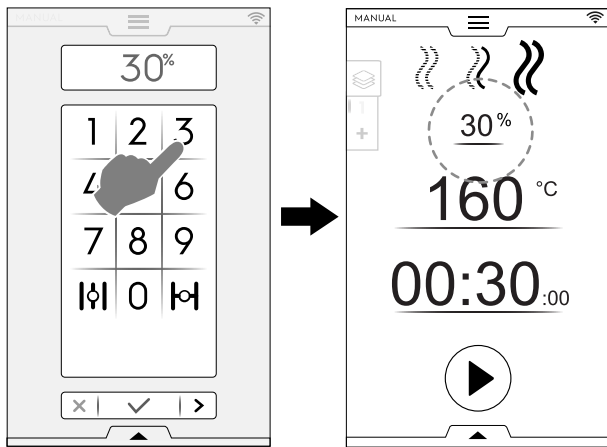

- Touch VENT OPEN option

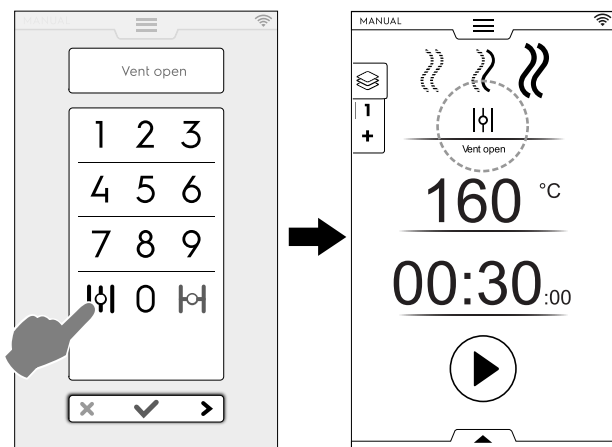

### F.6.9 TIME OPTION

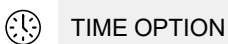

TIME OPTION

### CONTINUOUS COOKING

- If this option is activated the cooking cycle is endless.

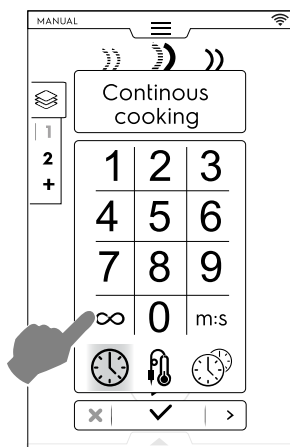

When the food is cooked hold down  button.

### DISPLAYED TIME

- If this option is activated the time displayed is converted from hours/minutes to minutes/seconds and viceversa.

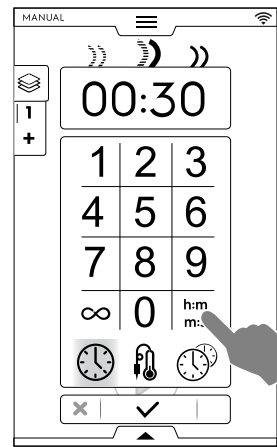

### F.6.10 FOOD CORE PROBE OPTION

The core probe allows accurate control of the core temperature of the product being cooked. This option excludes the cooking time setting.

#### FOOD CORE PROBE OPTION

#### Probe temperature

Values to be set:	from 15 to 290°C
-------------------	------------------

When the set value is reached, the oven stops automatically.

#### Probe types

 Adjustable PROBE to measure the product core temperature

 Adjustable PROBE for data transmission on USB pendrive.

 MULTIPOINT core probe with 6 sensors along the entire stem, for correctly measuring the product core temperature even if the tip is not completely in the centre (ONLY with specific models).

Depending on the model, ovens are equipped with MULTIPOINT core probe or SINGLEPOINT core probe. MULTIPOINT core probe with 6 sensors along the entire stem, for correctly measuring the product core temperature even if the tip is not completely in the centre.

## How to use a probe

1. Touch the time and select the CORE PROBE option;

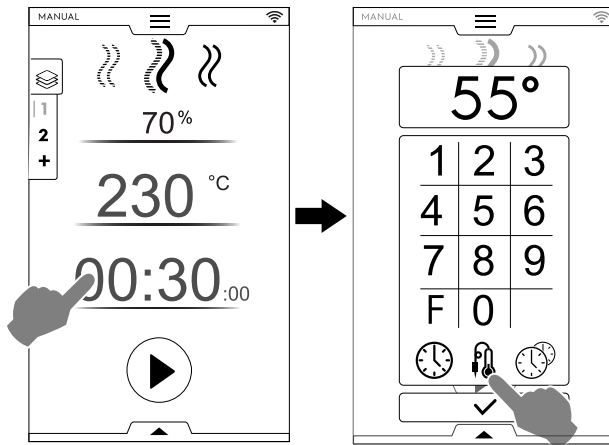

Pasteurization factor (if activated)

- F Touch "F" to insert the factor value to be reached by the end of the cooking cycle.

2. Select the most appropriate probe and enter the core probe temperature on the numeric keypad (e.g. 55 °C).

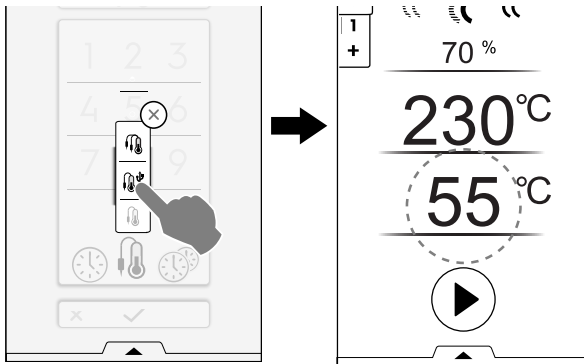

3. Touch button to start the cycle. Wait until the display indicates that the preheating (or precooling) phase is finished.
4. Open the door, insert the food into the cavity;



### WARNING

Risk of burns. Always open the door with caution when the oven is hot.

5. Remove the core probe from its seat and insert it in the product without forcing excessively; Make sure the tip (the sensitive part) is positioned near the centre of the product.  
It is important to place the core probe correctly near the centre of the product, making sure the tip does not protrude and, in particular, that it does not touch the pan.

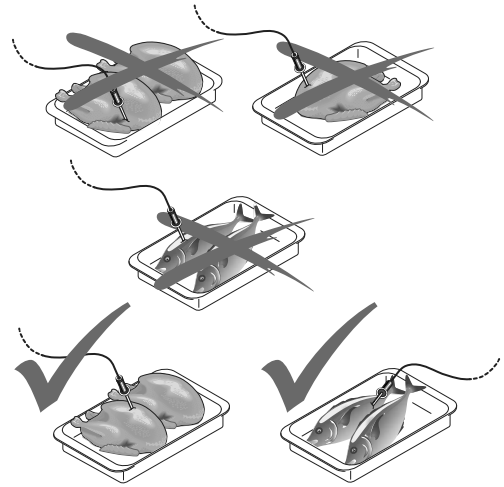

### IMPORTANT

The core probe is a precision component. Absolutely avoid impacts, forcing when inserting, and pulling of the flexible cable (in particular when using the trolley-mounted structures).  
The warranty does not cover the replacement of core probes damaged by improper use.

6. Close the oven door.  
The PROBE cycle keeps running.

### End Probe cycle

- When the required product core temperature is reached the oven stops automatically. The display shows the duration of cooking cycle;

### Probe cycle deactivation

- To deactivate the PROBE cycle just press the TIME button and set a cooking time. This action automatically cuts out the core probe and viceversa.  
When the oven is switched off the core probe option is also deactivated.



### NOTE!

With vacuum packed food products it is necessary to use the special external core probe (accessory available on request), to be connected to the USB pendrive. For its use, see the instructions included with the accessory.

### USB probe

If you set a cycle with the USB probe and the probe is disconnected from the appropriate port, after the preheating the

display shows an alarm with the indication that the cycle will be aborted within 2 minutes.

- To resume the cycle reconnect the USB probe before the 2 minutes are elapsed.



### F.6.11 MULTITIMER OPTION

MultiTimer system allows to set a different time for each recipe (chicken, potatoes, etc.) or for each pan placed on the various levels (level 1 for the top pan, next levels for lower pans).

This function also allows the oven to be used with "à la carte" menu, where the food can be placed in the oven at the required time during the same cycle.



**NOTE!**  
This function cannot be selected in a multiphase cycle.



MULTITIMER OPTION

#### Setting a MultiTimer option

1. While setting a manual program, select MultiTimer option and confirm;

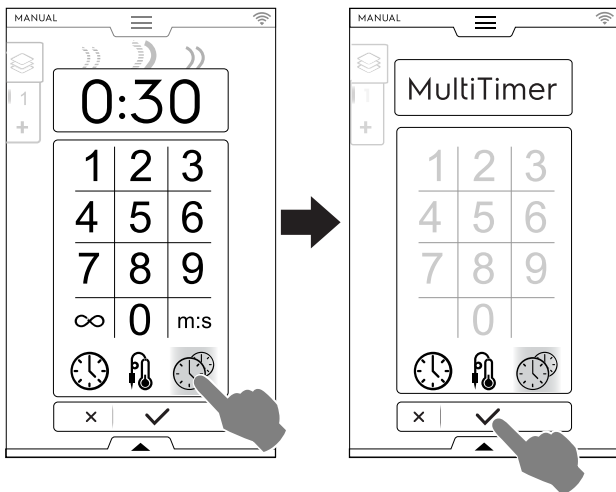

2. Touch the vertical MultiTimer bar on the left of the screen. A pop-up window opens. Touch each row to create a new preset: type the new name on the keypad and confirm.

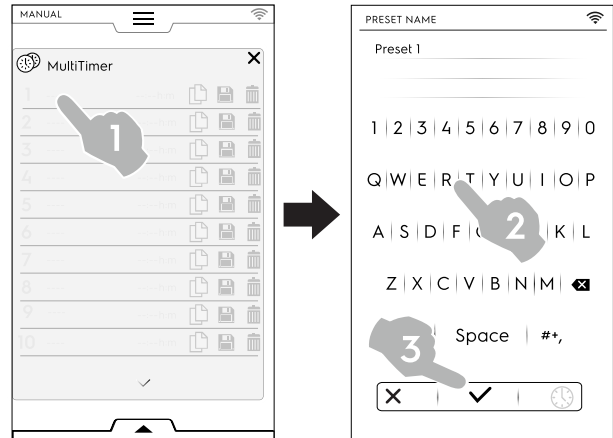

3. Set the preset duration or the food core temperature. There are two ways to do it:

- While naming the preset touch the time icon (clock) on the keypad to access the edit page;

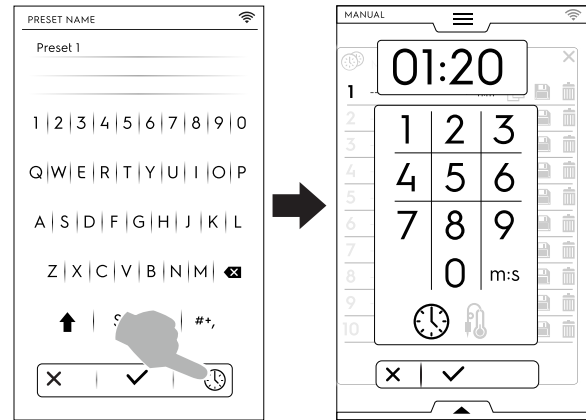

- Touch the time area on the right part of the row;

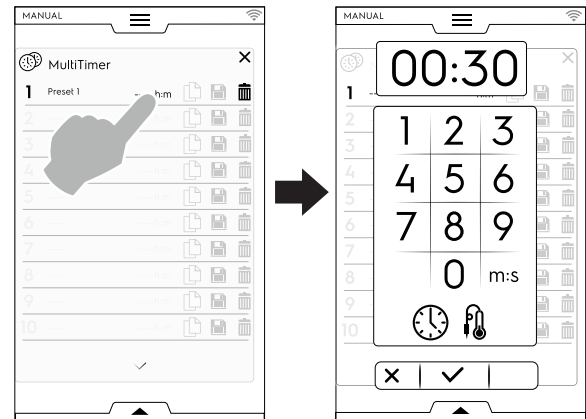

When creating more presets, the display shows the most similar presets or the presets compatible with the just set preset.

- Touch “+” to create and add a new preset.

Touch  to search an existing preset or select a preset from the list proposed.

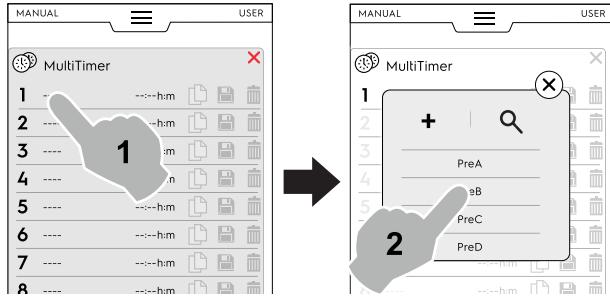

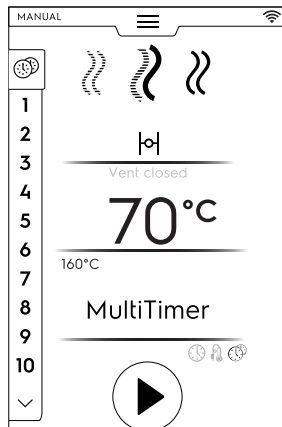

It is possible to add up to 60 presets.

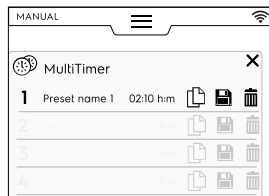

- After having set the required presets, the icons on the right become available.







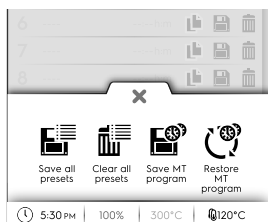

As per management presets it is possible to:

-  Duplicate the Preset
-  Save the Preset (available only for new presets)
-  Delete the Preset

- Additional actions on the program can be done through the lower drawer. Open the lower drawer to:



-  Save all presets  
Save all preset instead of saving them one by one.
-  Clear all presets  
Delete all presets instead of deleting them one by one.
-  Save MT program  
Save all the presets as a MultiTimer program.
-  Reload Presets  
Available only in a MultiTimer program, it allows to reload the deleted presets of a MT program.
-  Load MT programs  
It allows to load again a MT program.

4. Touch the button  to start the cycle. The preheating starts.
5. Insert the food in the oven, the core probe in the product (when needed) and close the door to start the cycle. The MultiTimer page list shows up on the display. The screen saver shows up to three presets: the remaining time (or the current food core temperature) and the name, when present. The presets are ordered from top to bottom according to minimum and maximum remaining time.

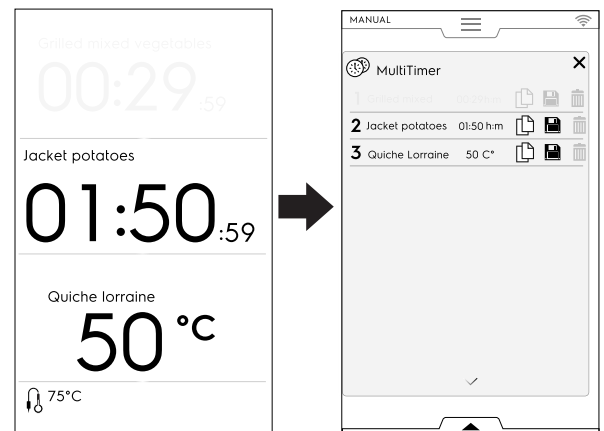

6. When a preset ends, some acoustic signals sound. The display shows the MultiTimer page list with the ended presets blinking in green. Open the door and remove food. After closing the door, the ended preset disappears from display.

**NOTE!**  
During a preset it is possible to add other presets. The reference number of the preset just added blinks (white) while the door is open to insert the food in the appliance. When the door is closed again the preset reference number stops blinking.

7. When the last preset ends and the food is removed, hold down the button  to stop the preset cycle.

**NOTE!**  
It is not possible to modify a running MultiTimer cycle. Changes on cycle parameters are allowed within certain limits only in idle mode .

## F.6.12 MULTIPHASE DRAWER

Food can be cooked with different modes during its cycle and therefore in different phases.

The oven enables programmes consisting of several sequential phases (up to a maximum of 16 phases).

During a programme, going from one phase to the next occurs automatically. The program automatically stops when all phases are completed.

## MULTIPHASE DRAWER

### How to set the Multiphase programme

1. Set first a cooking cycle, (refer to F.6 *MANUAL MODE* paragraph);

2. Add a new phase;

There are two ways to add a phase:

- Touch the “+” icon in the Multiphase Drawer;

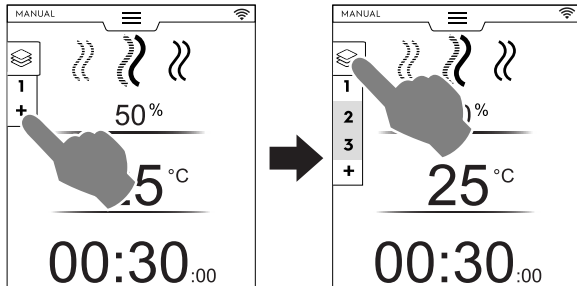

The appliance adds further phases. Touch the Multiphase Drawer to check the phase list.

Touch each phase row to assign new parameters.

- Open the Multiphase Drawer and touch “Add cycle” icon.

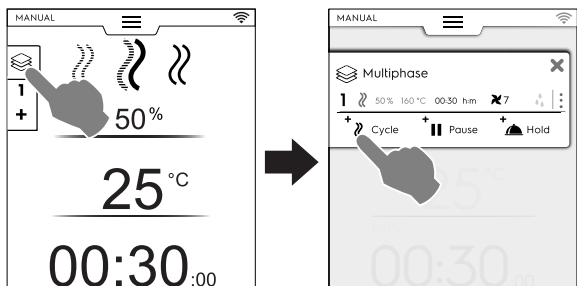

#### + Add Cycle

Touch this icon to add a new phase.

The oven adds default phases. Touch the phase row to set new parameters.

#### + Add Pause

Touch this icon to add the Pause phase.

#### + Add Hold

Touch this icon to add the Holding phase.

The default temperature of the Holding phase is 70 °C, if necessary, touch the corresponding row to change it.



#### NOTE!

The HOLD phase appears always at the end of the list and cannot be moved and copied.

It is possible to add a maximum of 16 phases + Hold phase.

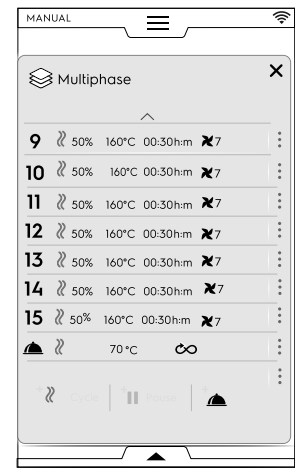

3. Set the parameters of the new added cycles and touch button to start the cycle.

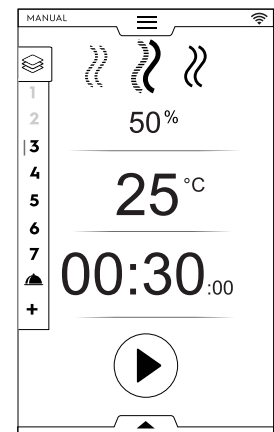

The running phase is highlighted in green. The phases in grey in the list are already being performed.



#### IMPORTANT

Additional phases can be added during the functioning of a multiphase cycle.

#### Phases management:

- Touch the 3 dots on the right to open a mini pop-up with the actions Write, Move, Duplicate and Delete.

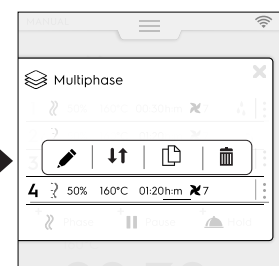
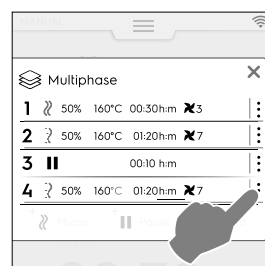

#### NOTE!

The pop-up opens only if the cycle has not started yet.

- Touch icon in red to close the mini pop-up.



#### Write a text

Touch this icon to write a text to be displayed at the beginning of that specific phase.



### ↕ Move phase

Touch this icon to change the position of the phase.  
The other phase numbers start blinking.  
Touch the required phase number to select the new position.

### 🗑 Delete phase

Touch this icon to delete immediately the phase. Touch this icon to delete also the delay start.

### 📄 Duplicate phase

If there is only one phase, it is not possible to move or delete a phase but only Duplicate.



### IMPORTANT

To keep the changes above described always save the program and overwrite it (using the lower drawer).

### SKIP option (available during a running programme only):

1. Touch the three dots on the right of the selected phase to open the mini pop-up with Skip function.



### NOTE!

The pop-up opens only if the cycle has already started.

2. Touch Skip icon to leave the current phase and start immediately the selected phase.

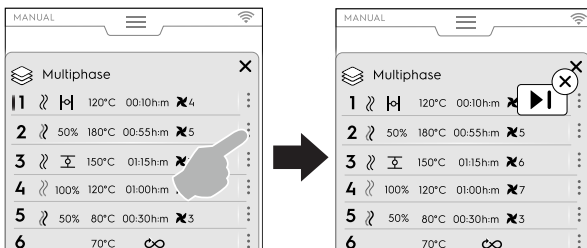

### Lower drawer functions:

- Further actions can be done through the lower drawer:

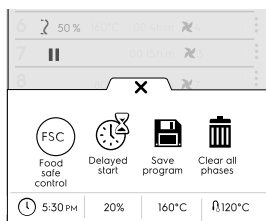

### 💾 Save program

Touch this icon to save and store customized cycles in Program mode. Type a name on the numeric keypad to be assigned.

Touch this icon also to save changes made to an existing program.

### 🗑 Clear all phases

Touch this icon to delete all the phases in the Drawer Multiphase and start again from phase 1.

Before clearing the phases in the drawer, a pop-up window opens up asking for confirmation.



### Delayed start

Touch this icon to postpone the start of a program.  
Type the delay time on the numeric keypad.



### FSC Food safe control

Touch this icon to enable the control of the microbiological safe condition of the food while using a program.

## F.7 AUTOMATIC MODE

The “Automatic mode” allows to perform automatically cooking food in easy-to-use way, just setting a few simple functions.

Cooking in “Automatic mode” means no need to know cooking parameters values (temperature, time and humidity) and get excellent cooking results for each type of food.

### F.7.1 SET AN AUTOMATIC CYCLE

1. Open the upper drawer and select Automatic mode

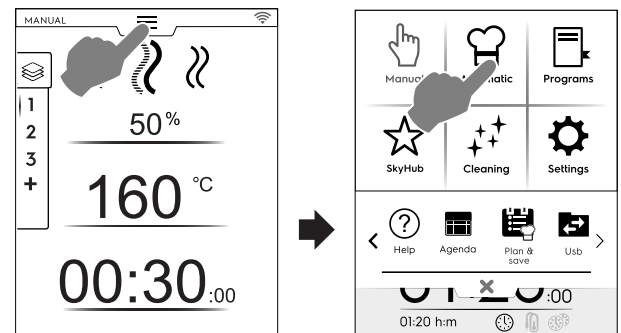

2. Select a food type;

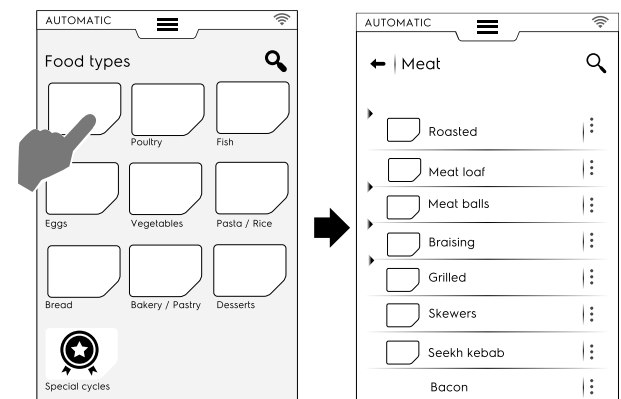

3. Select the category food and the required associated preset;



Each category may have more presets associated with it.

- Select the required preset and, if required, set the parameters.  
If needed, change the temperature and/or the cooking control;

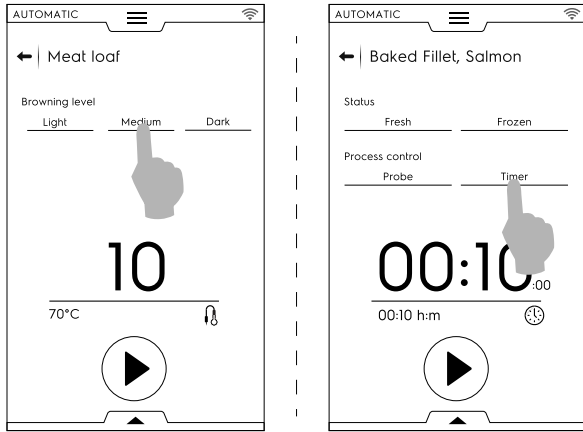

Some presets are entirely automatic.  
The display shows that no parameters can be set.

Other presets allow to change a few parameters:

- Browning Level
  - Cooking Control (timer/probe).
  - Food status
- Once modified the cycle with the new parameters, it is possible to save it as a "customized preset";

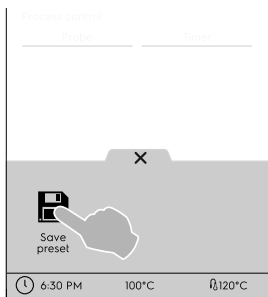

- Touch the icon to save the preset;
- A pop-up window opens showing the message to overwrite the preset;
- Touch ✓ icon to confirm or ✗ icon to save a new preset.

### Customized presets management

- Touch the 3 dots to associate a picture, rename or delete the presets you have created.

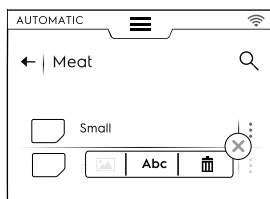

- It is also possible to delete selected presets by means of the lower drawer:

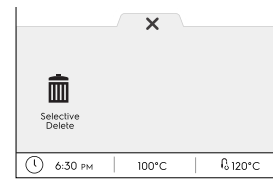

Select one or more presets showed on the display and confirm deletion.

- Touch ▶ start the cycle;  
The preheating (or precooling) starts.



#### NOTE!

During the cavity preparation it is still possible to make some changes on the parameters.

- When the preheating phase is over, insert the food into the cavity;
- At the end of precooling/preheating insert the food in the cavity, the core probe in the product (when needed) and close the door to start the cycle.
- Sensing/Temperature recovery functions start.  
These functions analyse the cavity conditions to optimise the cycle according to the type and load of food.

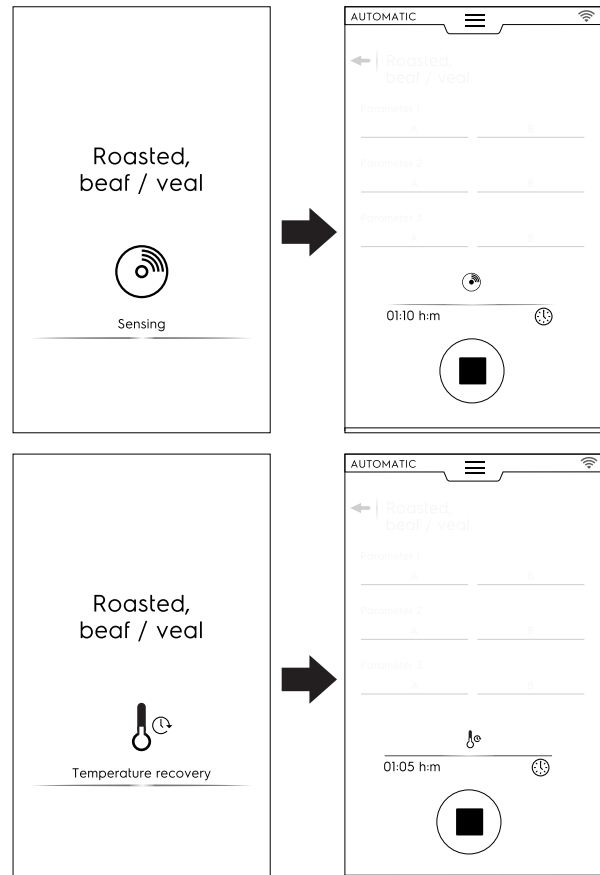

9. After Sensing/Temperature recovery phases end, a screen saver appears during the cycle. It is possible to customize its view through the lower drawer. Open it and choose the most suitable one.

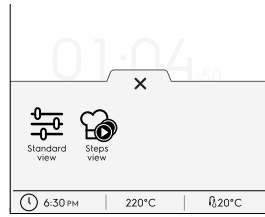

Standard view



Steps view



10. At the end of the cycle the display shows the following information:

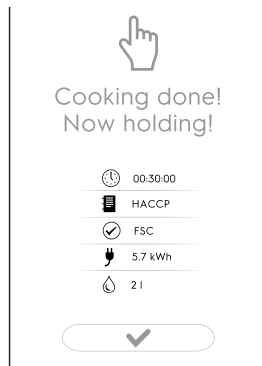

Time consumption in hours : minutes : seconds



HACCP  
(recipe data stored into HACCP log)



Reference standard used (if enabled)  
The check shows if the standard guide is successful.



Electric consumption in kWh



Water consumption in litres

## F.7.2 UPDATE/RESTORE AUTOMATIC CYCLES

It is possible to update the automatic cycles stored in your oven using an USB pendrive or, if needed, restore the previous cycles before updating.

You can find the version of the automatic cookings stored in your oven in the identity card page. See related paragraph F.17.21 *IDENTITY CARD* in "Settings" chapter.

### UPDATE AUTOMATIC COOKINGS

Refer to *Update automatic cookings* paragraph in "Settings" chapter and obey the following instructions:

1. Insert in the appropriate port the USB pen drive with the automatics cookings UPDATE;
2. Select "Update Automatic cookings" command. The oven searches for Automatic cookings in the USB pendrive.

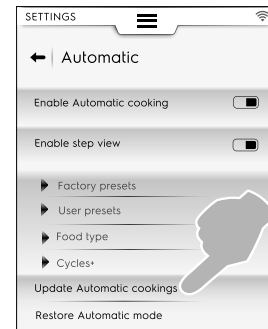

If the oven has found a new version of Automatic cookings, asks for update confirmation.

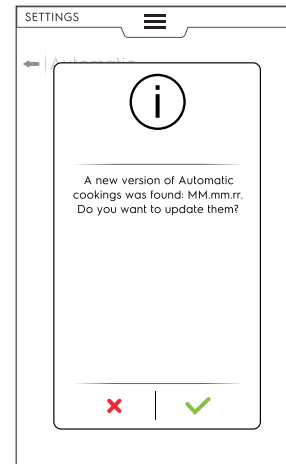

Before the update it could be that:

- the USB pen drive is not inserted properly. Verify the USB pendrive connection and select again the update of Automatic cookings.
- the Automatic cooking files are not found. Verify that the USB pendrive contains the updated cooking files.
- the Automatic cookings are not compatible with your software version.
- the latest version of Automatic cookings is already installed. There is no need to update them.

3. Touch ✓ to proceed. The oven updates the files and displays a feedback.



During the update it could be that:

- Something goes wrong. Retry the update of Automatic cookings.
- The USB pen drive is inadvertently removed. The operation is aborted.

### RESTORE AUTOMATIC COOKINGS

Refer to *Restore automatic cooking* paragraph in “Settings” chapter and obey the following instructions:

- Select “Restore Automatic mode” command.

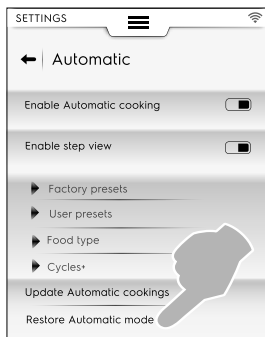

### Without any previous update of the Automatic cookings

1. The oven asks for confirmation about the automatic Mode removal.

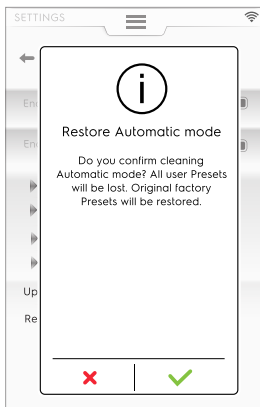

2. Touch ✓ to proceed. The oven updates the files and displays a feedback

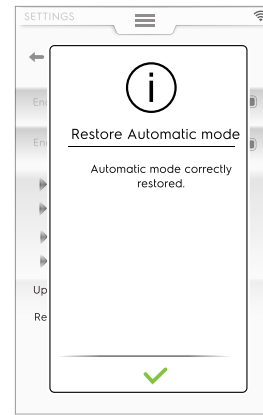

### With a previous update of the Automatic cookings

1. The oven asks which item of the automatic Mode must be removed.

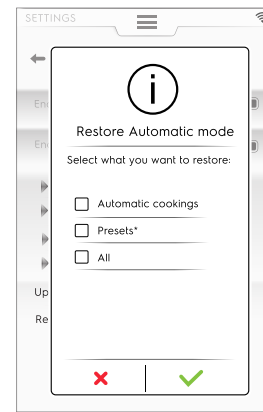

- If you select “Presets”, a message warns you that all presets that you created will be lost and restored that factory ones.

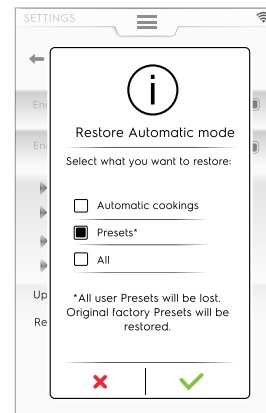

- Touch ✓ to proceed. The oven restores the files and displays a feedback.

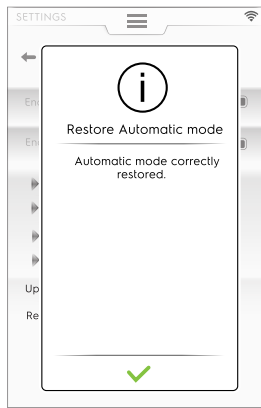

During the restoring it could be that:

- Something goes wrong. Try to restore the Automatic mode again.

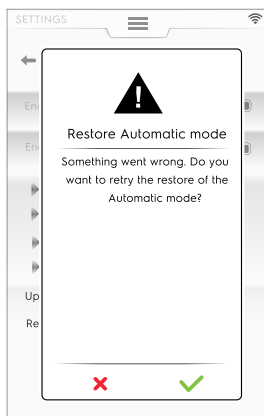

### F.7.3 CYCLES+ / SPECIAL CYCLES

This mode contains special cooking approaches designed to obtain specific results.



#### Special cycles/Cycles+

Touch this icon to enter the cycles list:



#### F.7.3.1 Low Temperature Cooking



#### LOW TEMPERATURE COOKING

Low Temperature Cooking is an automatic preset programme for foods cooked evenly with a soft texture.

The holding phase keeps food safe according to HACCP standards for up to 24 hours.

The programme is composed of following main phases:

- Preheating
- Searing: dry thermal sealing of food
- Cooling
- Maturing: slow cooking
- Holding: keeping food at required temperature

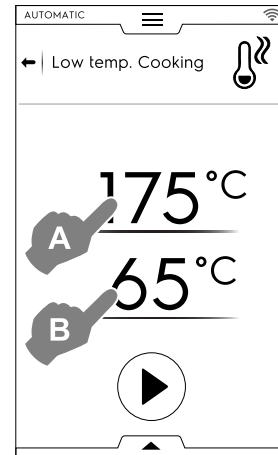

- Set the SEARING temperature "A" ;
- Set the final temperature of the PROBE "B"
- Touch ▶ button to start the cycle.



#### IMPORTANT

During the preheating phase it is advisable to put the probe outside the cavity.

#### Cycle displaying

- The cycle displaying can be customised as standard or steps view. Open the lower drawer and touch the required icon:

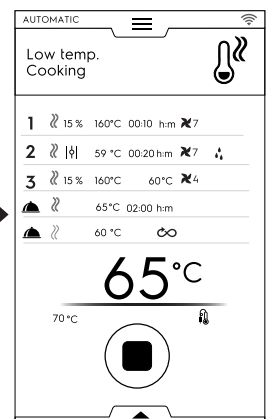
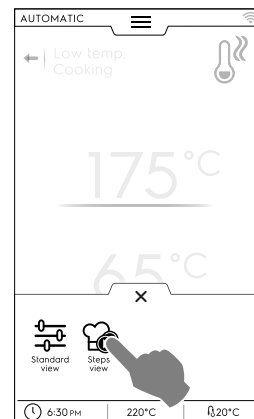

## Saving presets

- Once the cycle is set, it is possible to save it as a preset; Open the lower drawer and select the related icon.

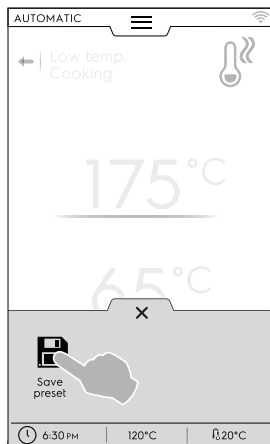

## Managing presets

- If you have already saved Low Temperature Cooking presets, they show up as a list. Touch three dots to change image, rename or delete the presets (see the same procedure in the *Image, name, category link and deletion of stored programs* paragraph in F.8 PROGRAMS MODE chapter).

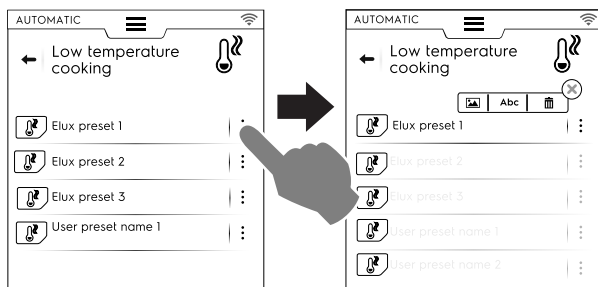

- Further actions can be done through the lower drawer. See the available functions with presets through lower drawer in the *Customized presets management* paragraph in this chapter.

At the end of the cycle the display shows the consumptions (if available) as a recap message.

### F.7.3.2 Eco Delta Cooking

#### ECO DELTA COOKING

This special cycle adjusts the cavity temperature to maintain a constant difference (delta) with the food core probe.

- Set the humidity value;
  - Set the delta value for the cavity temperature;
  - Then set the core probe temperature;
- The display shows the set humidity value (A), for the cavity temperature the delta value set (B) and for the probe the current and the target values (C);



#### NOTE!

If creating more phases at least one of them must be driven by probe with the cavity temperature set as a delta from the food core temperature probe value. Otherwise the START button is disabled and the message "Eco delta cooking program invalid" pops up.

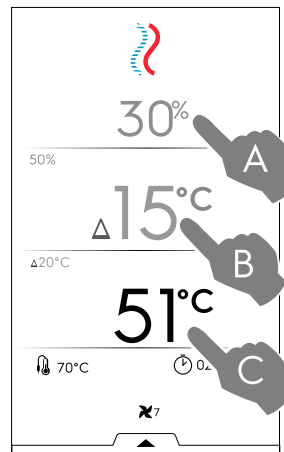

- Touch button to start the cycle.
- Once the cavity temperature is reached, load the oven and insert the food probe in the product.

At the end of the cycle the display shows the consumptions (if available) as a recap message.

### F.7.3.3 Regeneration



#### REGENERATION

This cycle is a set of categories and cooking cycles to reheat chilled food keeping the humidity controlled. It works as a standard automatic cycle.

To start a regenerating cycle, proceed as follows:

1. Access the cycle;

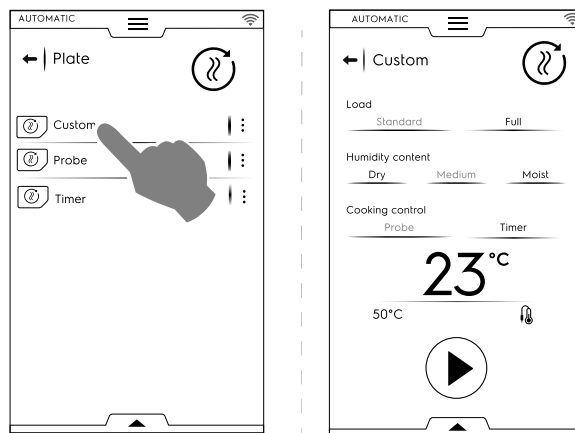

2. Set the parameters defining the status of the food to regenerate;
3. Touch button to start the cycle.



#### CAUTION

Cold food shall not to be added to the cavity for regeneration while the Maintaining (HOLD) phase is operating.

At the end of the cycle the display shows the consumptions (if available) as a recap message.

### F.7.3.4 Static Combi



#### STATIC COMBI

This cycle simulates static cooking using a more gentle air distribution. The oven performs the cycle in manual mode without the fan adjusting.

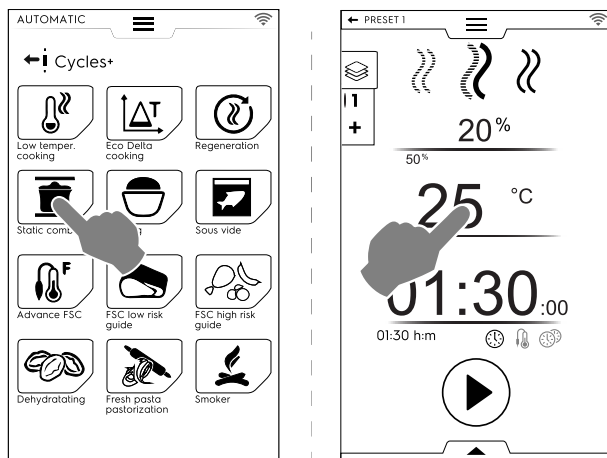

### To start a static combi cycle, proceed as follows:

1. Select a preset, if created;
2. Close the door and touch button to start the cycle.  
If the cavity temperature is lower or higher than the set temperature the oven starts a cooling or a preheating phase.
3. When the oven has reached the cooking temperature, load the oven and, if necessary, insert the food probe in the product.

The fan speed is not adjustable.

At the end of the cycle the display shows the consumptions (if available) as a recap message.

It is possible to save and store the performed presets; see how to manage them at *Customized presets management* paragraph of this chapter.

### F.7.3.5 Proving

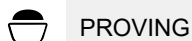

PROVING

Controlled humidity, thanks to the unique lambda sensor, and temperature allow the oven work like a proving cabinet, to prove any pastry or bakery product.

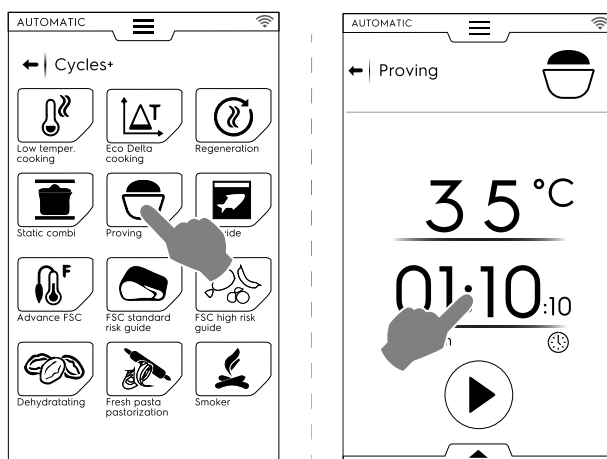

### To start a Proving cycle proceed as follows:

1. Set the temperature from 25 to 50 °C;
2. Set the time;
3. Touch button to start the cycle.  
If the cavity temperature is lower or higher than the set temperature the oven starts a cooling or a preheating phase.
4. Once the set cavity temperature is reached, load the food into the oven.

At the end of the cycle the display shows the consumptions (if available) as a recap message.

It is possible to save and store the performed presets; see how to manage them at *Customized presets management* paragraph of this chapter.

### F.7.3.6 Sous Vide

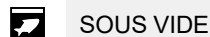

SOUS VIDE

This is a steam cycle suitable for cooking food previously vacuum sealed in a plastic bag. This special cycle allows to cook or to regenerate the food.

The oven works in manual mode with the only STEAM cycle available;

- If required, change the cavity temperature;
- Set the time or
- set the core probe temperature (if only the "USB sous vide food core probe" is available for the appliance).
- Touch button to start the cycle.

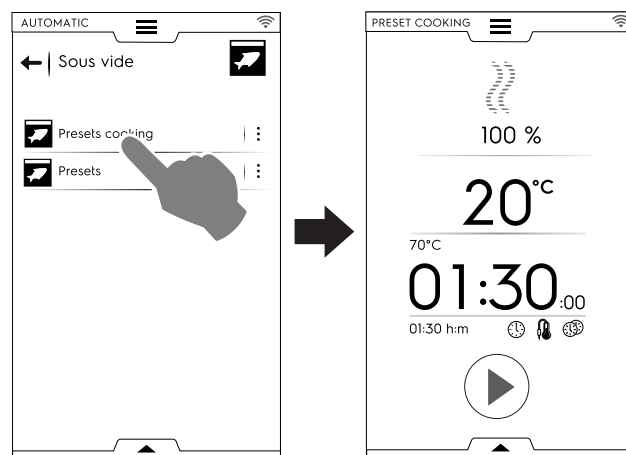

At the end of the cycle the display shows the consumptions (if available) as a recap message.

### F.7.3.7 Advanced FSC

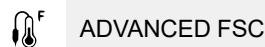

ADVANCED FSC

This cycle associates the reaching of pasteurization factor to the end of the cooking cycle.

This cycle is performed as a manual cycle.

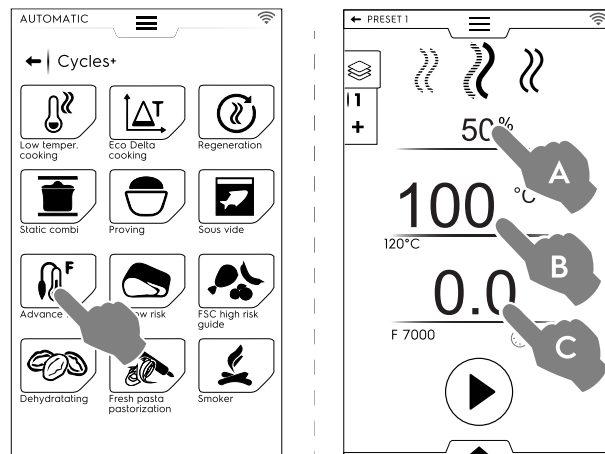

### To start an Advanced FSC cycle proceed as follows:

1. Set the humidity (A);

2. Set the temperature (B);
3. Set the Pastorization factor (C);
4. Touch  button to start the cycle.  
If the cavity temperature is lower or higher than the set temperature the oven starts a cooling or a preheating phase.
5. Once the set cavity temperature is reached, load the food into the oven and the food core probe into the product.  
When the "F" parameter is reached the cycle finishes.

At the end of the cycle the display shows the consumptions (if available) as a recap message.

It is possible to save and store the performed presets; see how to manage them at *Customized presets management* paragraph of this chapter.

### F.7.3.8 FSC Standard Risk

#### FSC STANDARD RISK

The FOOD SAFE CONTROL (FSC) is a device enabling the microbiological SAFE condition of the food to be controlled during cooking. This option recognises the moment when the food reaches an acceptable sanitisation level for its SAFE consumption.

The process requires strict compliance with proper food processing practices according to the rules of hygiene, before and after cooking.



#### NOTE!

Cooking using the FSC does not sanitise bad or deteriorated food, which remains so even after cooking.

The cycle is performed with presets in MANUAL mode with FSC  option enabled.

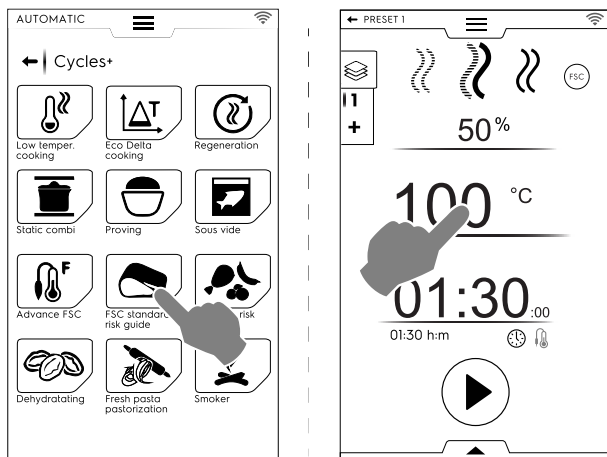

#### To set the FSC Standard Risk cycle proceed as follows:

- Set humidity, temperature and time of the cycle;
- Touch  button to start the cycle;  
If the cavity temperature is lower or higher than the set temperature the oven starts a cooling or a preheating phase.
- Once the set cavity temperature is reached, load the food into the oven and the food core probe into the product.
- At the end of the cycle, the oven check if the food has reached the required sanitisation level:

- If the FSC parameter is satisfied a recap message informs about the successfully ending of the cycle;

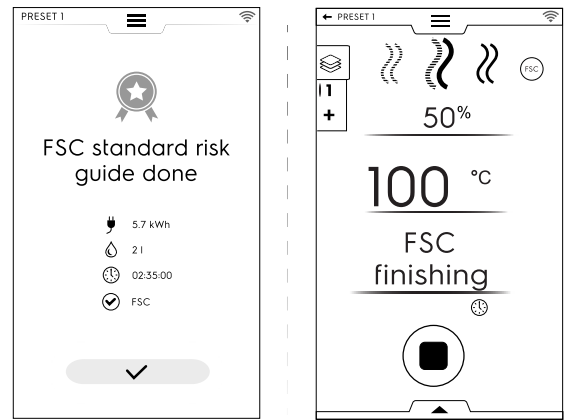

- If the FSC parameter is NOT satisfied a message warns about the need to prolong the cycle until the food is in safe conditions for its consumption.

It is possible to save and store the performed presets; see how to manage them at *Customized presets management* paragraph of this chapter.

### F.7.3.9 FSC High Risk

#### FSC HIGH RISK

For foods having a high contamination level. (e.g. roulades of meat, mince-meat, poultry, pork, fish)

The cycle is performed with presets in MANUAL mode with  option enabled.

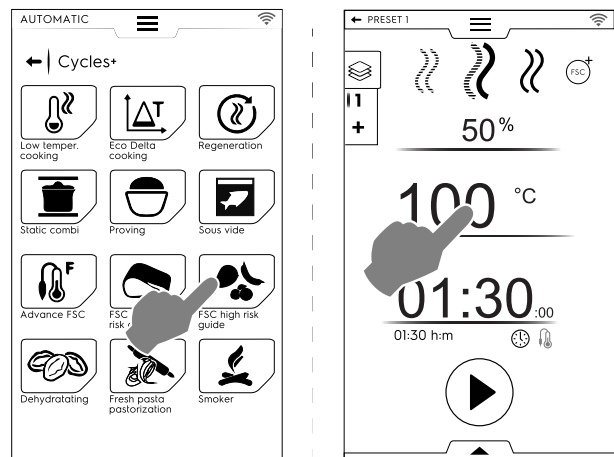

#### To set the FSC High Risk cycle proceed as follows:

- Set humidity, temperature and time of the cycle;
- Touch  button to start the cycle;  
If the cavity temperature is lower or higher than the set temperature the oven starts a cooling or a preheating phase.
- Once the set cavity temperature is reached, load the food into the oven and the food core probe into the product.
- At the end of the cycle, the oven check if the food has reached the required sanitisation level:



- If the FSC parameter is satisfied a recap message about ending cycle pops up;

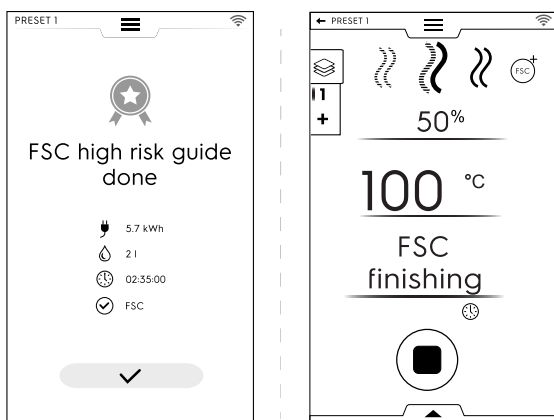

- If the FSC parameter is NOT satisfied a message warns about the need to prolong the cycle until the food is in safe conditions for its consumption.

### F.7.3.10 Dehydration

#### DEHYDRATION

This cycle quickly dehydrates fruits, vegetables, meat and fish. It eliminates the liquids from the food ingredients by making the oven chamber dry thanks the highest air evacuation flow (up to 90 m<sup>3</sup>/h).

The oven works in manual mode with the only CONVECTION cycle available with the vent OPEN.

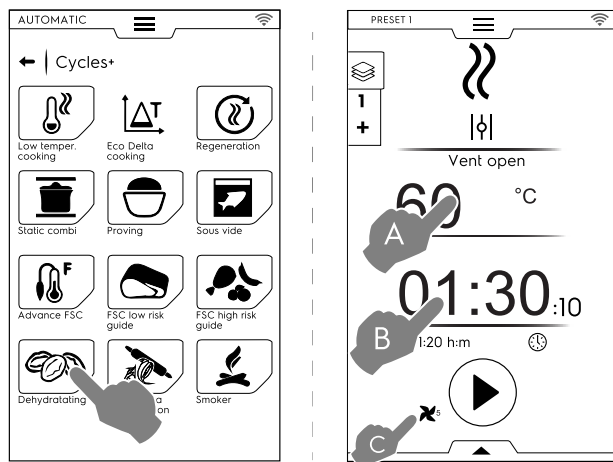

**To set the Dehydration cycle proceed as follows:**

- Set temperature (A), time (B) and speed fan (C);
- Touch ► button to start the cycle;  
If the cavity temperature is lower or higher then the set temperature the oven starts a cooling or a preheating phase.
- Once the set cavity temperature is reached, load the food into the oven.

At the end of the cycle the display shows the consumptions (if available) as a recap message.

It is possible to save and store the performed presets; see how to manage them at *Customized presets management* paragraph of this chapter.

### F.7.3.11 Pasteurization of Pasta

#### PASTEURIZATION OF PASTA

This cycle is a special preset suitable for fresh pasta pasteurization.

The oven works in manual mode with the only STEAM cycle available.

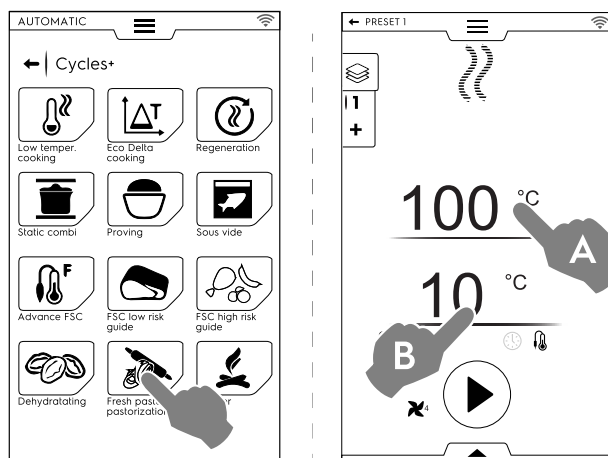

**To set the cycle proceed as follows:**

- Set the cavity temperature (A);
- Set the core probe temperature or the time (B);
- Touch ► button to start the cycle;

If the cavity temperature is lower or higher then the set temperature the oven starts a cooling or a preheating phase.

- Once the set cavity temperature is reached, load the food into the oven and the food core probe into the product.

At the end of the cycle the display shows the consumptions (if available) as a recap message.

It is possible to save and store the performed presets; see how to manage them at *Customized presets management* paragraph of this chapter.

## F.8 PROGRAMS MODE

The “Programs Mode” allows to recall program recipes already stored or downloaded from cloud and/or create and store new ones.

1. Select Programs mode. The display shows all stored programs.

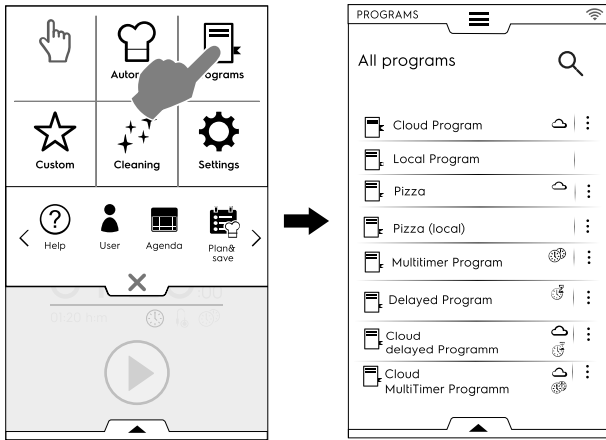

To change the programs displaying from a list to a grid open the lower drawer and select grid visualization:

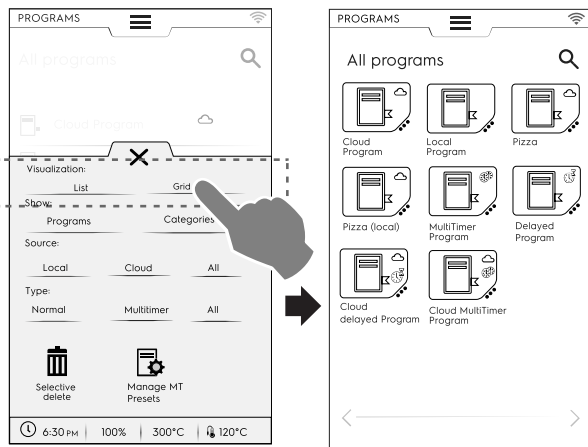

When displaying the programs, the oven gives you a general information about the type of program and its source:

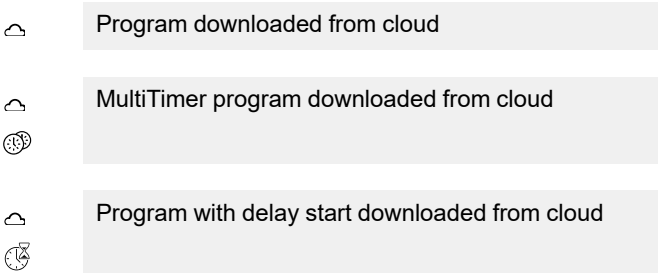

2. Touch the required program;  
The oven loads the program in Manual mode ready to be launched.

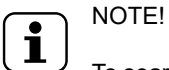

**NOTE!**

To search a programme touch icon  and digit the name on the appearing keypad. The display will show the programs most similar to the one you typed.

### How to create and save a program

- Select a cycle in Manual mode (see F.6 *MANUAL MODE* chapter);
- If necessary modify the cooking parameters according to your requirement;
- Open the lower drawer and touch the relevant icon to save the programme;

- Edit the program name on the appearing keypad and confirm.

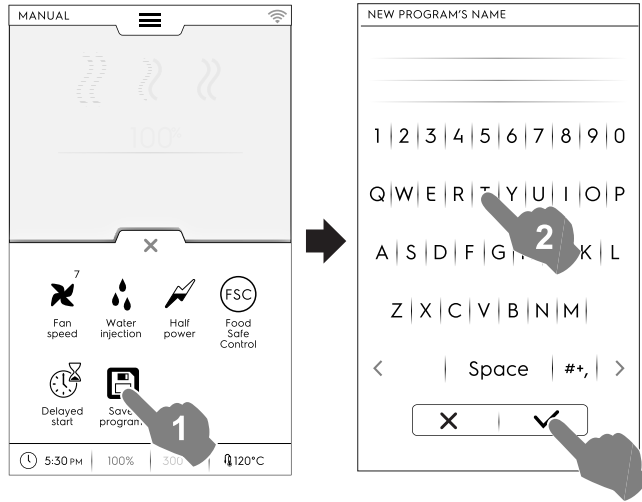

The new program will be stored in Programs mode.

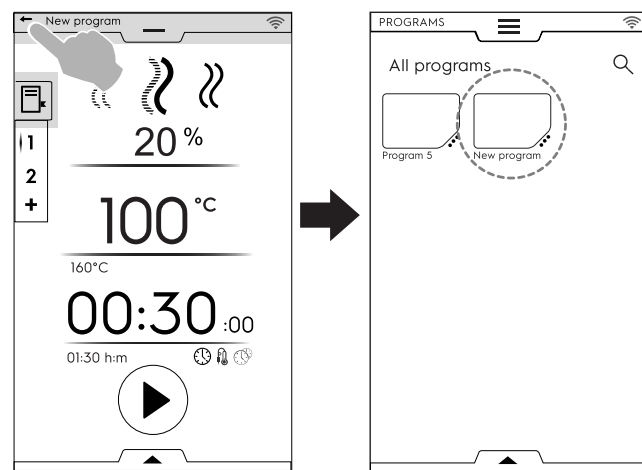

### Image, name, category link and deletion of stored programs

1. Touch the 3 dots near the program icon to access the "features management" menu;

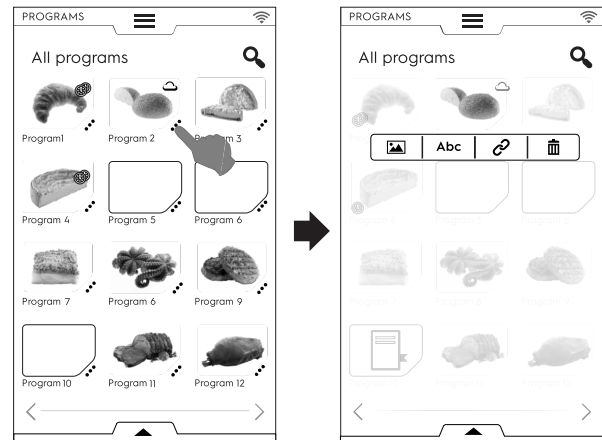

CHANGE IMAGE

- Touch the image icon to change the default image; Choose the required image and confirm it.

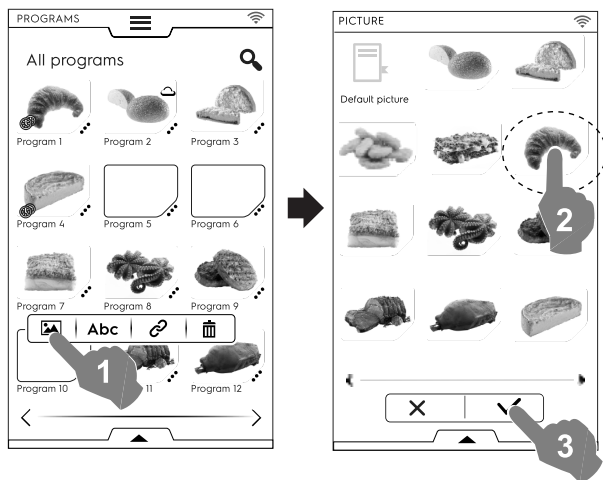

### EDIT NAME

Abc

- Touch “abc” icon to edit the programme name; Digit the new name and confirm it.

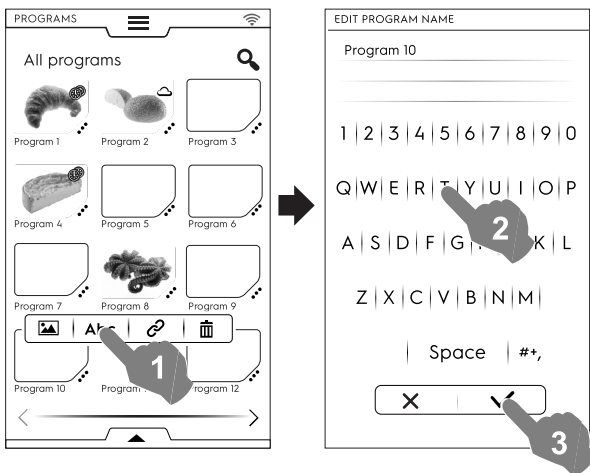

### LINK TO CATEGORY



- Touch link icon to associated the program to a category;

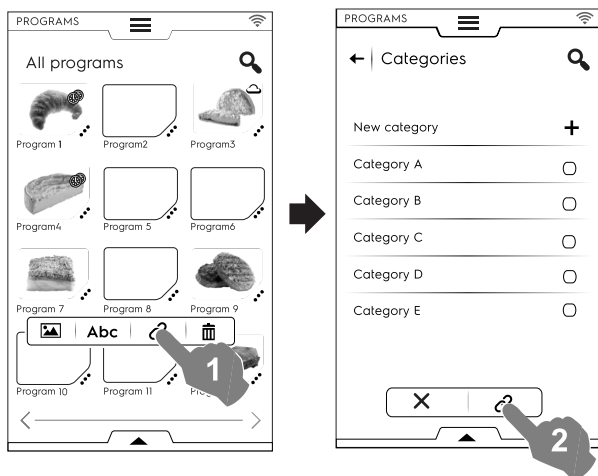

Once a category is selected, touch the link button.



### DELETE PROGRAM

- Touch the recycle bin icon to delete a program; Confirm to delete.

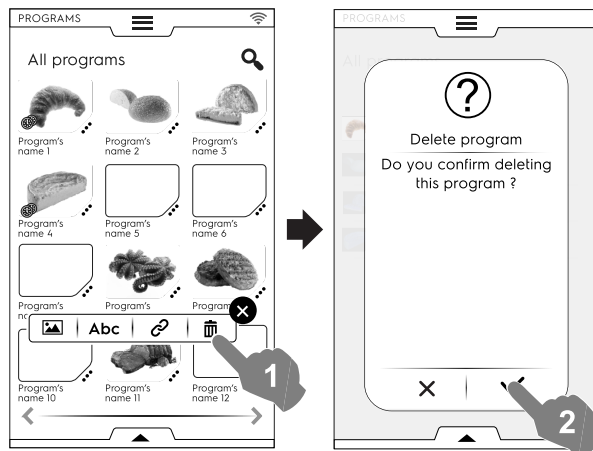

### Programs management through lower drawer

Open the lower drawer and:

- select “Programs” to see the list of all programs;

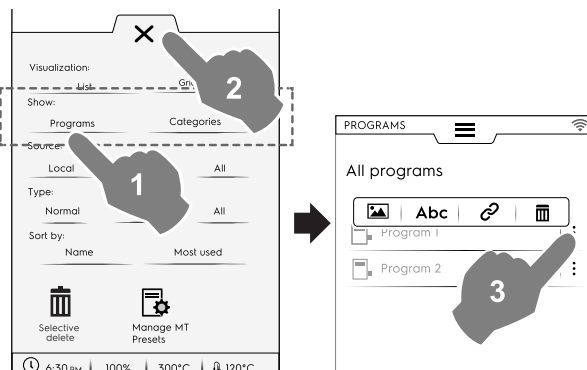

### NOTE!

For all programs displaying, the three vertical dots on the right side of the selected program open a popup window that allows to add a picture, rename the programme, link it to a category and delete it.

Always touch X to close the drawer.

- select “Categories” to see the list of all categories; Each category expands showing the linked programs.

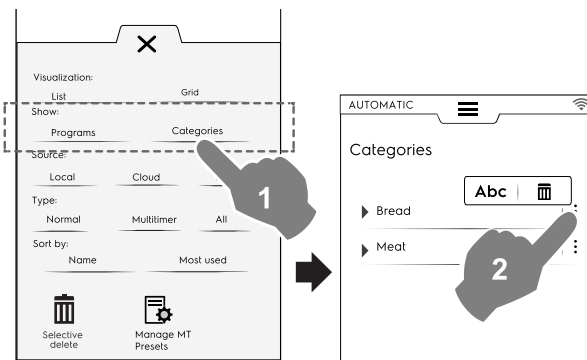

- select "Local", "Cloud", or "All" to display the programs by their source or to display all programs;

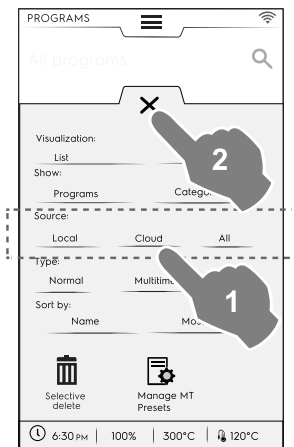

- select "Normal", "MultiTimer", or "All" to display the programs by their type;

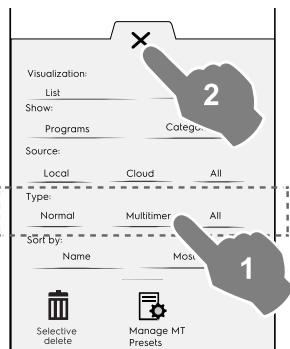

- select "name" or "Most used" to sort the required programs;

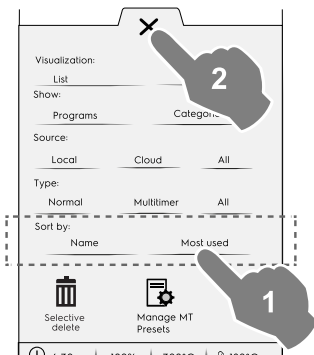

### Selective delete function

- Open the drawer to select the programs to be deleted. The list of the programs appear on the display.

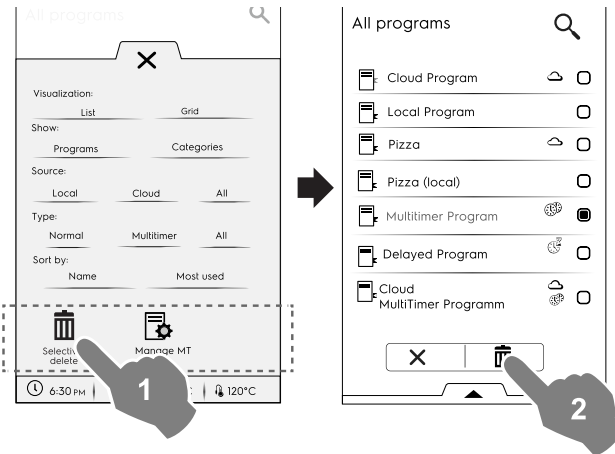

- Select the programs to be deleted or open the drawer again and select:

- if you want to be selected all the programs;

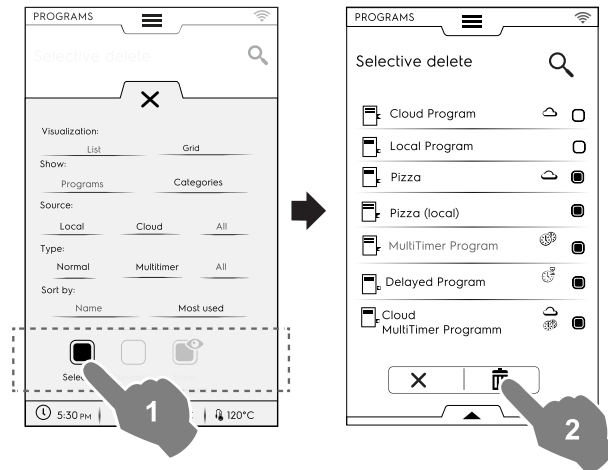

- or select one of the following options:

- if you want to be deselected all the programs;

- if you want to display only the selected programs;

Always close the drawer to see applied your selection on the display.

## Manage MT Presets

It is possible to rename/delete the Presets and display the information associated to the program which includes them.

- Touch the corresponding icon.

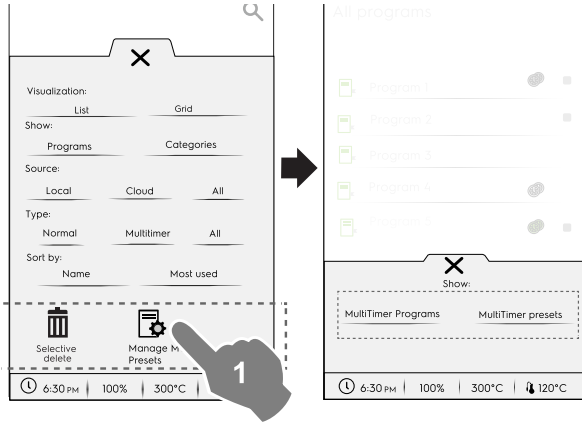

- Select **MultiTimer programs** to see the MultiTimer programs containing the presets.

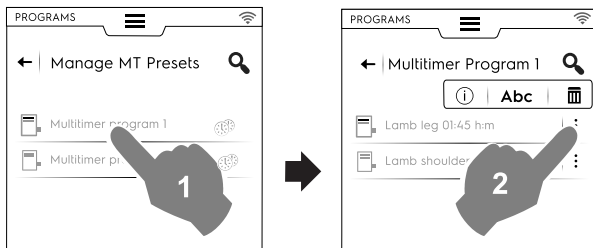

- Select **MultiTimer presets** to see all the presets saved and present in all MultiTimer programs.

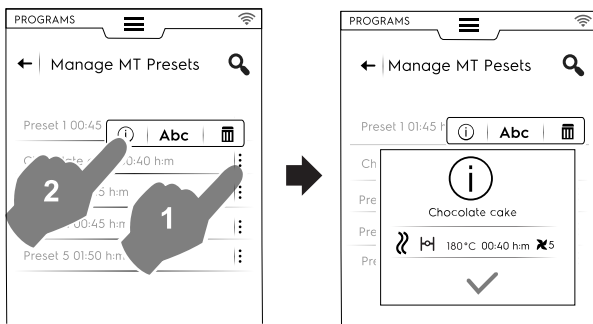

2. Select a program of the list and touch button to start it;

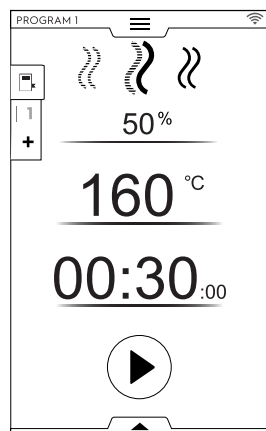

### NOTE!

Once recalled the program, it is till possible modify it adding more **phases** or more **presets**.

## Adding phases to a program

- Touch the Multiphase drawer to display all the phases composing the entire cycle;
- Add more phases (see *How to set the Multiphase programme* paragraph);
- Touch **X** icon to close the EDIT window;

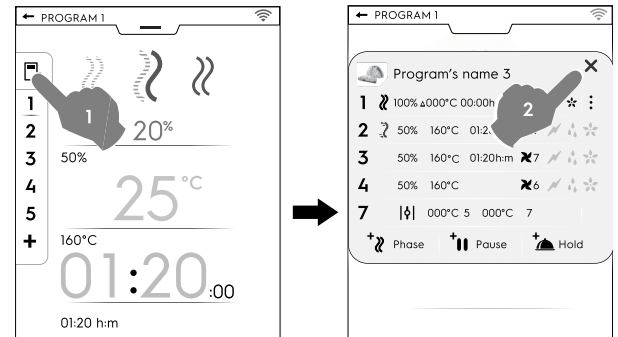

- Open the lower drawer and save the program:

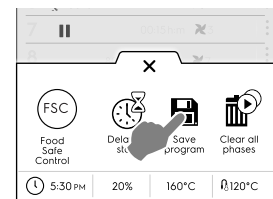

- Edit the same program name on the appearing keypad to overwrite the existing one;
- Enter a new name to save the program with the just added phase.

## Adding presets to a MultiTimer program

- Touch the MultiTimer drawer to display all the presets linked to a programme;
- Add more presets (see *Setting a MultiTimer option* paragraph);
- Touch **X** icon to close the EDIT window;

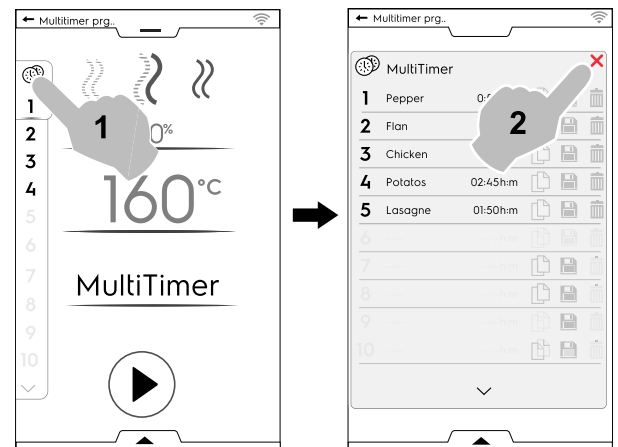

- Open the lower drawer to:
  - save all presets to save the last cycle added;
  - save the MT program. If it is typed the same name of the just modified program, the display asks to overwrite the existing program.

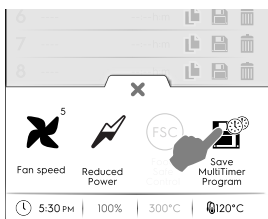

## F.9 HOMEPAGE FAVORITES MODE (SKYHUB/SOLOMIO)

This mode is a repository of links to the most used features of the oven and allows to customize the display menu according to your needs.

- Select SkyHub mode;

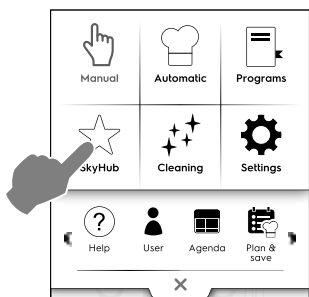

- The first time you access the menu, all items are empty. You can create a folder containing the most used features or a direct link to your favorite feature.

Touch “+” to add a folder or the required function;

### Creating a folder

- Touch “+” and select ;

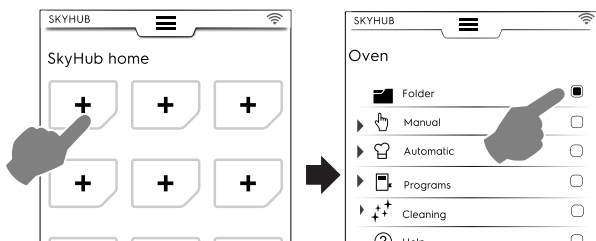

- you are requested to give immediately a folder title and to choose a picture from the proposed ones.

It is possible to rename, associate another picture or delete the folder anytime.

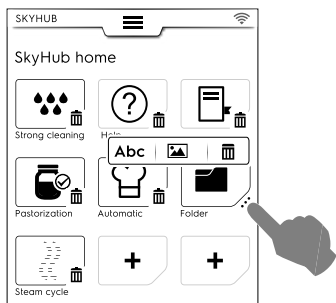

### Adding a link

- Select the required function (for example Strong cycle in Cleaning mode) and confirm it;

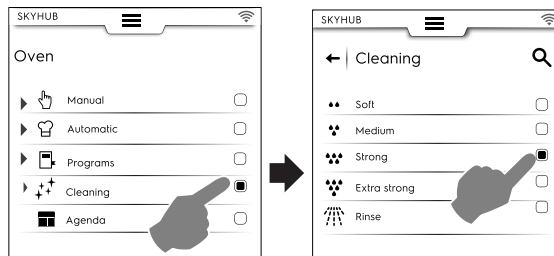

- To delete a function touch the icon  at the bottom corner.

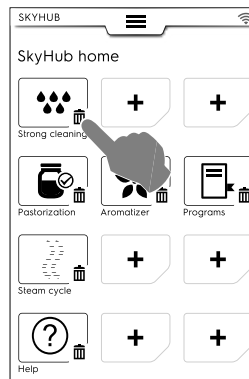

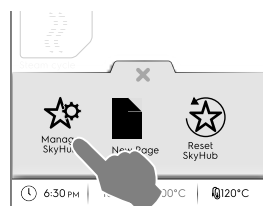

- To save your favourites open the lower drawer and touch “Manage SkyHub” icon.

The green icon becomes white. The display go out from the EDIT menu and goes back to the favourites list.



### Other features

- To create more pages:
  - Touch  and then .

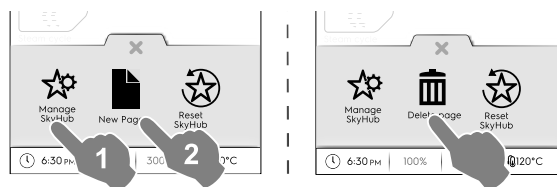

- To save the new page touch  again. The icon becomes white.

- To delete a new page touch the corresponding icon .

- To delete all links, folders and pages touch .

## F.10 HELP MODE

This function provides QR codes in order to display the user manual on your device (smartphone, tablet or laptop).

1. Make sure to have the application for QR code reading on your device and an internet connection available;

2. Select help mode;

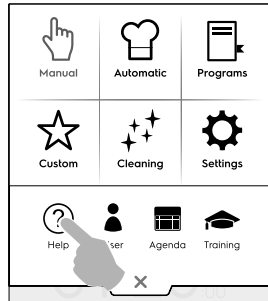

3. The display shows the QR code;

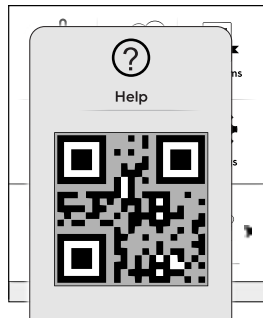

4. Scan the QR code;

5. Consult the documents needed;

## F.11 AGENDA MODE (CALENDAR – MY PLANNER)

This function  allows to plan oven activities, cooking or cleaning programs or to set reminders, according to your schedule.

1. Select the agenda function in the upper drawer;

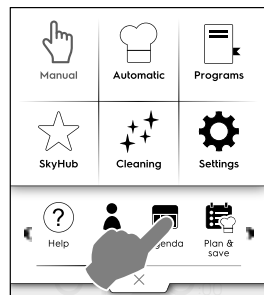

2. Select a date and time;

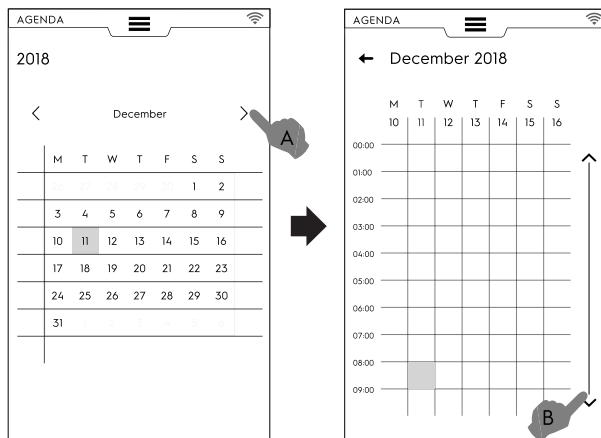

- Touch to scroll the months;
- Touch to scroll down the time;

3. Touch the required time;

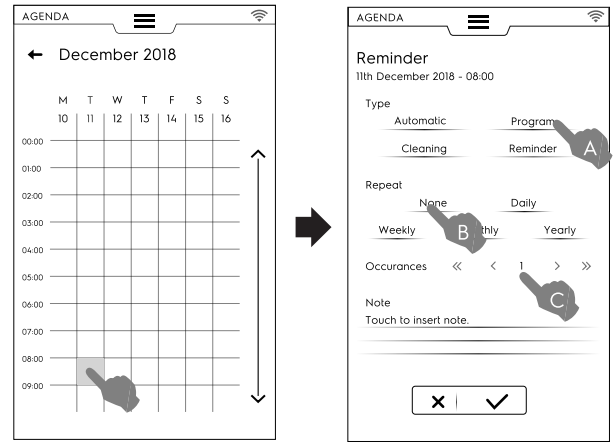

- Select the event type;
- Select the frequency;
- Select the event number.

### Program setting

- Select the date and the time;
- Select the event type – programs in this case; The display shows the list of the stored programs. Select the required program among the available ones;

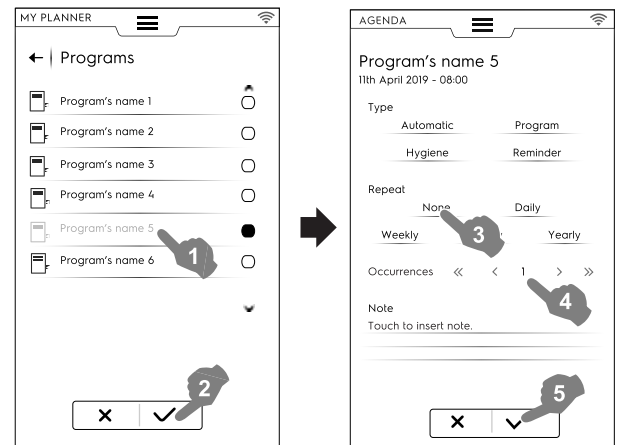

- Select the frequency and the occurrence;
- Touch  to confirm it; The display shows in the calendar the selected program at the required time;

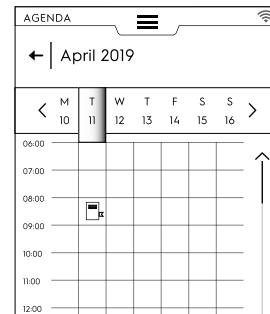

### Automatic program event

- Select the date and the time;
- Select the event type – Automatic in this case; The display shows the list of all food families stored;

- Select the required food family and the preset.  
The display shows the automatic program details.

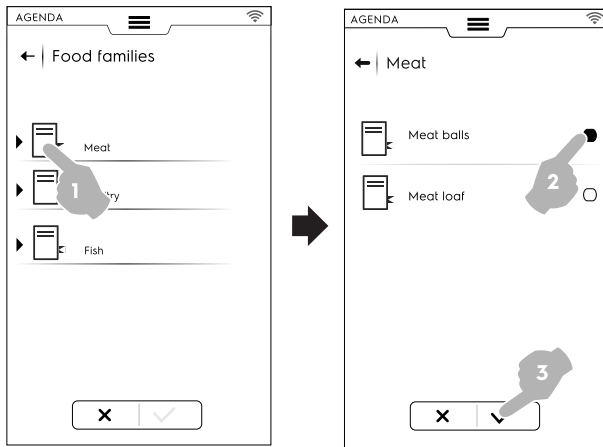

- Select the frequency and the occurrence;
  - Touch ✓ to confirm it;
- The display shows in the calendar the automatic program at the required time;

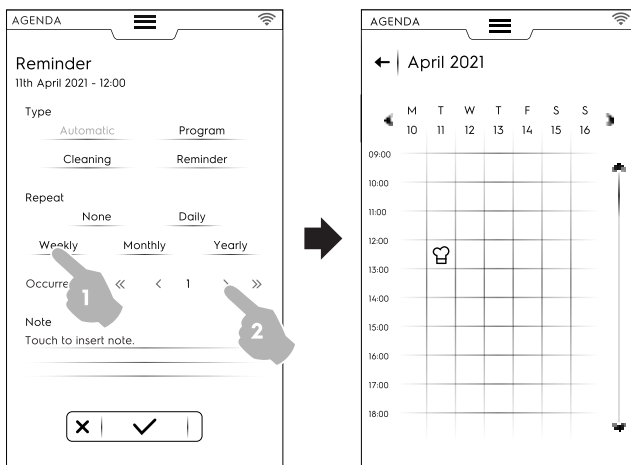

### Cleaning setting

- Select the date and the time;
- Select the event type – Cleaning in this case;  
The display shows the list of all cycles.
- Select the required cleaning cycle among the available ones;  
The display shows the selected cycle details.

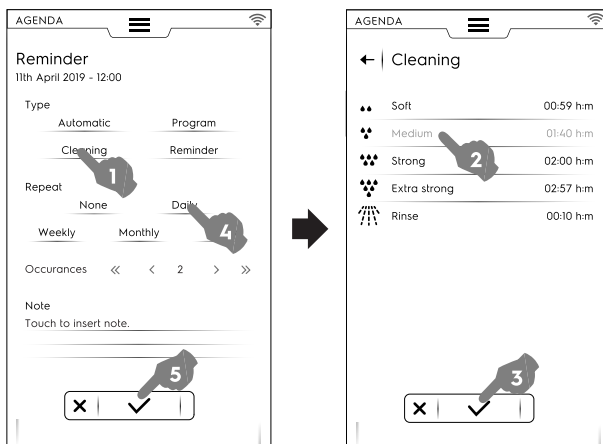

- Set the frequency and the number of cleaning cycle;
- Touch ✓ to confirm it;

The display shows in the calendar the selected event at the required time;

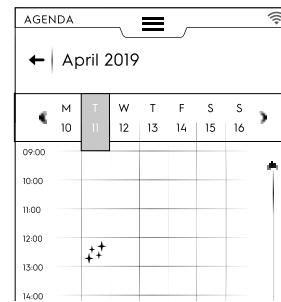

The display shows in the calendar the selected cleaning cycle at the required time;

### Reminder setting

- Select the date and the time;
- Select the event type – Reminder in this case;
- Type the reminder title on the keypad and touch ✓ to confirm;
- Type the reminder text in note field and confirm;

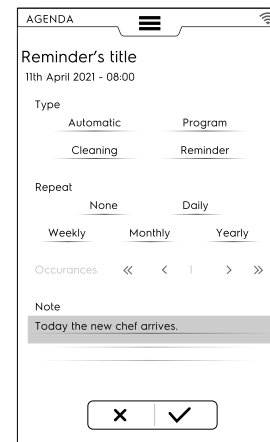

- Select the frequency and the reminder number and confirm;
- Touch ✓ to confirm it;

The display shows in the calendar the selected event at the required time;

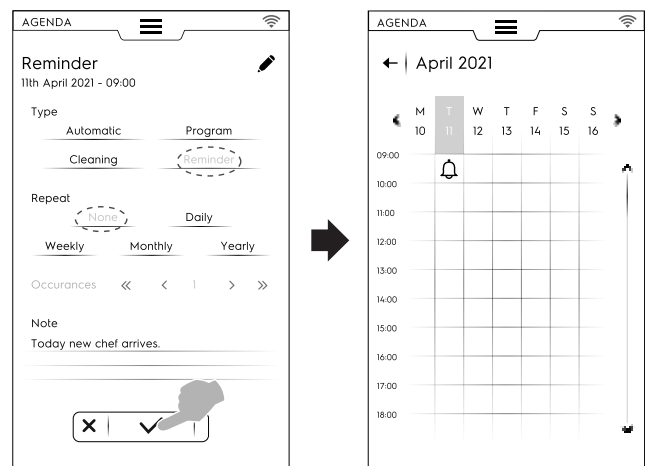

If there are other planned events on the calendar the display shows them up:



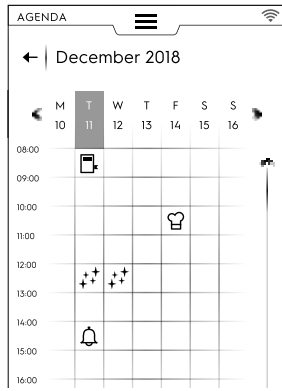

- If there is in agenda an event planned while the oven is still working, the appliance advises that the event cannot start. It is necessary to plan a new event.

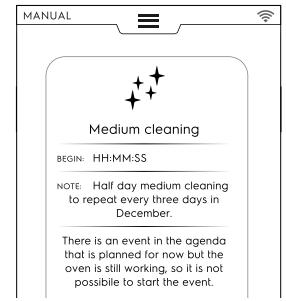
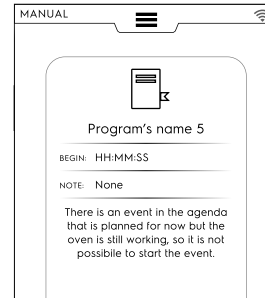

### Cancellation of an event

- Select an event and touch the icon  to delete;

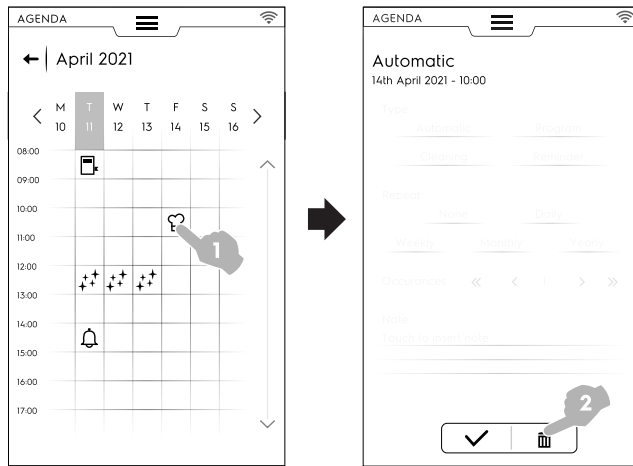

The calendar shows the event deletion:

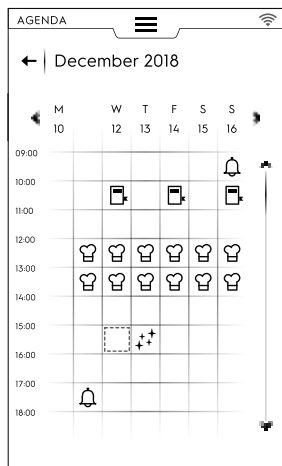

### F.12 USB MODE

“USB” mode allows to upload/download, from or into the appliance, programs, Multitimer presets or other data by means of the USB pendrive.

1. Select USB from the upper drawer.

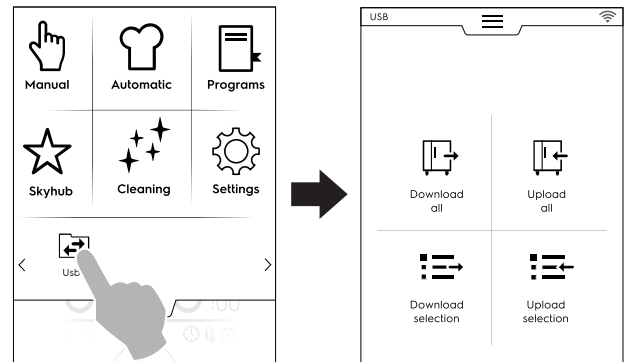

2. Choose the required function.

#### Download all

- Select Download all.
- Select the required items and confirm.

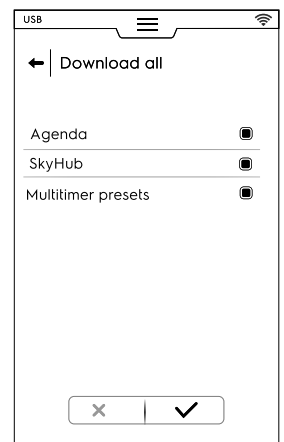
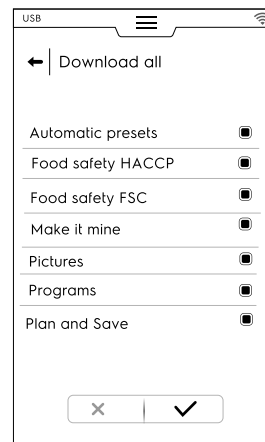

- The downloading can:
  - replace a backup in the list;
  - be saved with new name.
 Touch  to confirm it.

- If selecting an existing backup the oven overwrites the current one.

If selecting Add new name, type it on the appearing keypad. If the new name already exists, a popup window informs that the name has to be changed.

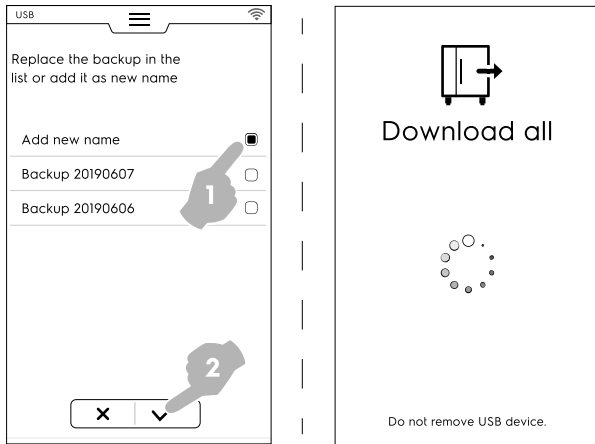

The download starts.



**NOTE!**  
Do not remove the USB pendrive during the download.

### Upload all

- Select Upload all.
- Select one of the existing backups. Then select the required items associated with the selected backup.

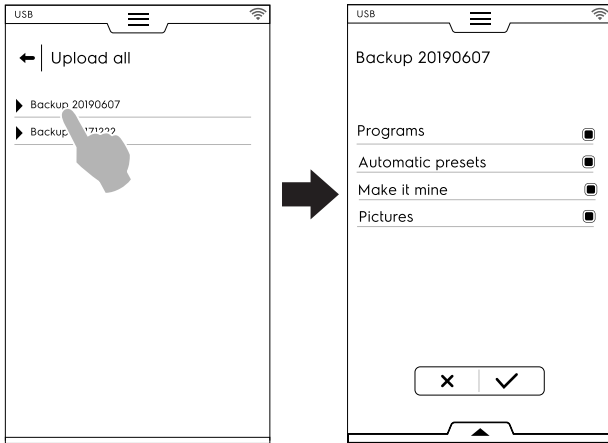

**IMPORTANT**  
If uploading programs, the programs present in the appliance will be lost

- Confirm the selection. The upload starts.

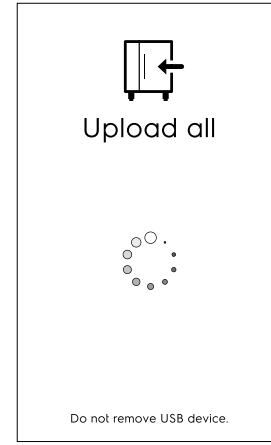

### Download selection

- Select Download selection.
- Expand the items. All files associated are selected.

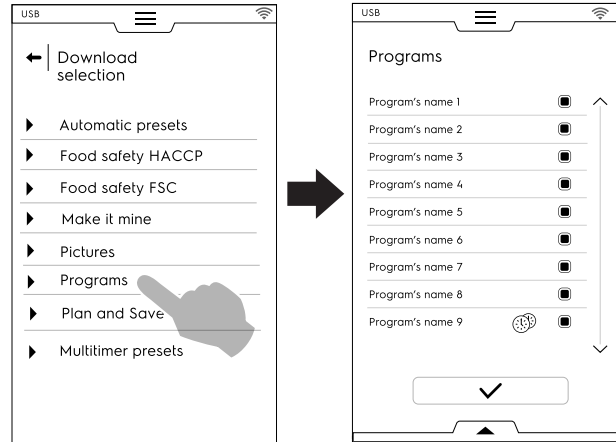

- Deselect the required files and touch ✓ to confirm it.

It is also possible to select all files or to check the selected ones through the **bottom drawer** :

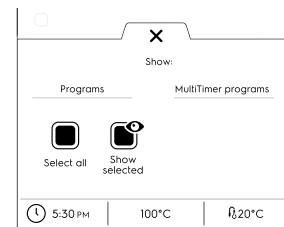

Select all

Show selected

Touch Programs and/or MultiTimer programs. When the wordings become green all the associated programs are shown on the display.

- The just created backup can replace an existing one or can be stored with a new name.

If the new name already exists, a popup window informs that the name has to be changed.

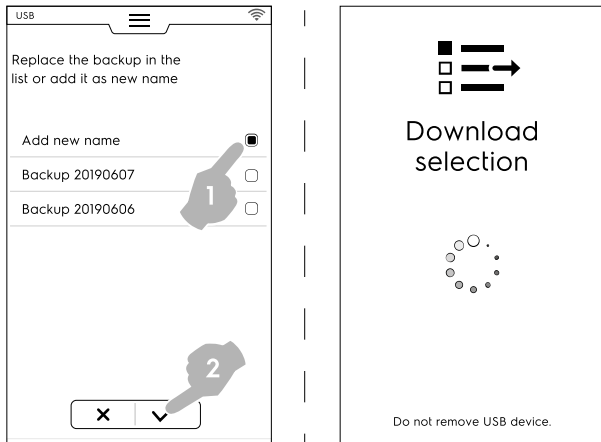

The download starts.



**NOTE!**

To download My Planner/Agenda data go to "Download all" menu and then deselect all data except for My Planner/Agenda.

**Upload selection**

- Select Upload selection;
- Expand the items. The backups associated are displayed;
- Select the required backup from the list.



- All files associated are selected. Deselect the not needed files and touch ✓ to confirm it.

Regarding the selected files, the oven asks to choose:

- adding them to the actual ones;
- clearing the existing ones and uploading the selected items;

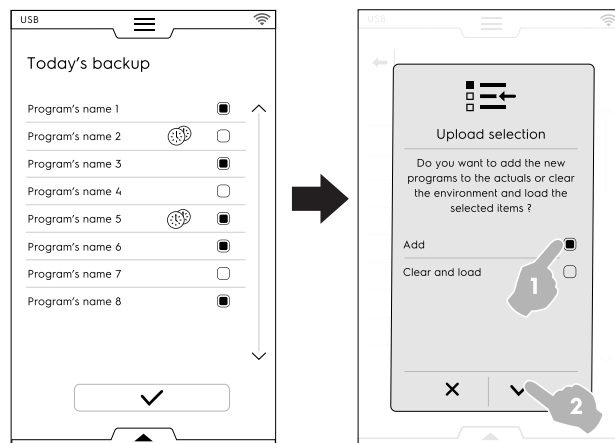

- If selecting "add" and a file name is already existing, a popup window asks how to proceed:

- Rename
- Replace
- Skip

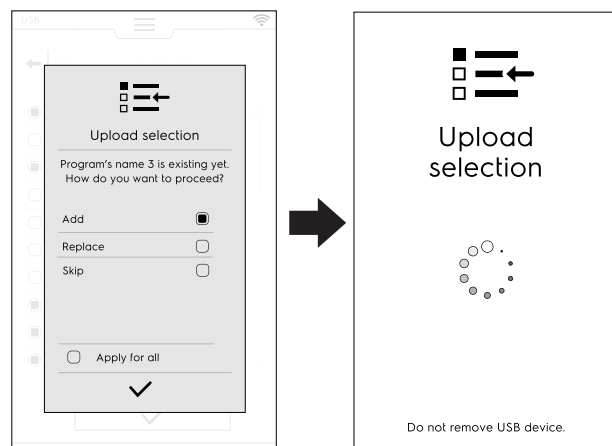

Confirm the selection; the upload starts.

**F.13 PLAN&SAVE/COOKING OPTIMIZER MODE**

This function allows you to optimise a series of consecutive cookings in order to reduce energy and water consumption of the transition phases.

- Select Plan & Save function in the upper drawer;

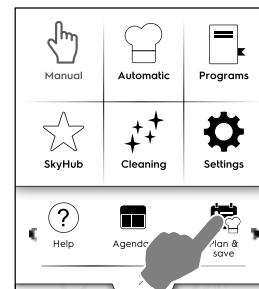

2. Select an existing list or create a new one;

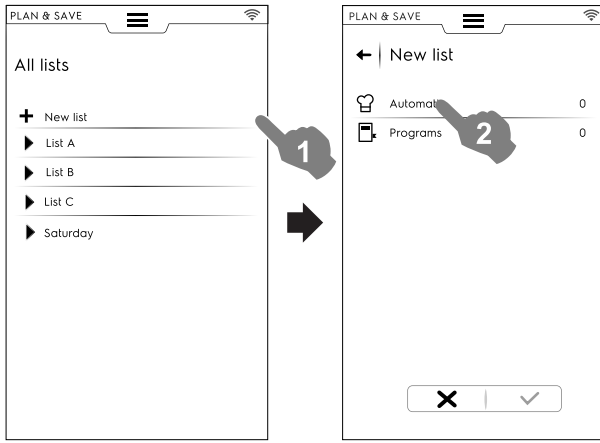

### Creating a new list

- Touch "+" to create a new list;
- Touch a row to select an automatic preset or a programme;

### Selecting an automatic preset

- Select AUTOMATIC: all food types are displayed; expand the required food type;
- Expand the items associated to find the required preset(s);

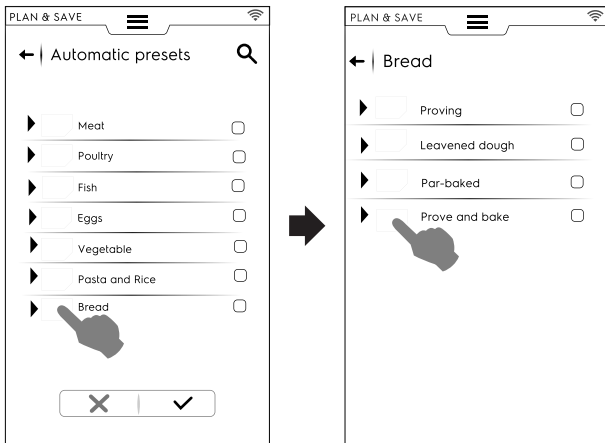

- Touch ✓ icon to confirm;



The display shows the recap page indicating the quantity of **automatic** presets selected.

### Selecting a programme

- Touch PROGRAMS: all the available programs are displayed;
- Select the required program(s);

- Touch ✓ icon to confirm it;

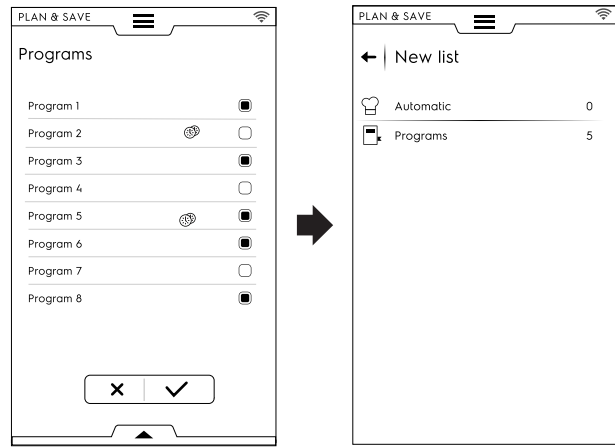

The display shows the recap page indicating the quantity of **programs** selected.

It is possible to select all programs or to check the selected one by means of the lower drawer:

- Open the lower drawer;
- Select the required function;

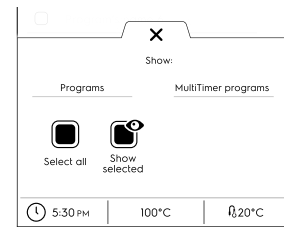

Select all

Show selected

3. Once you have selected a series of cooking processes:

- Touch ✓ icon to confirm them; the list of the selected cooking processes opens up;
- Touch ☺ icon to start the optimization;



- When the oven has optimized the sequence, press button to start the execution;

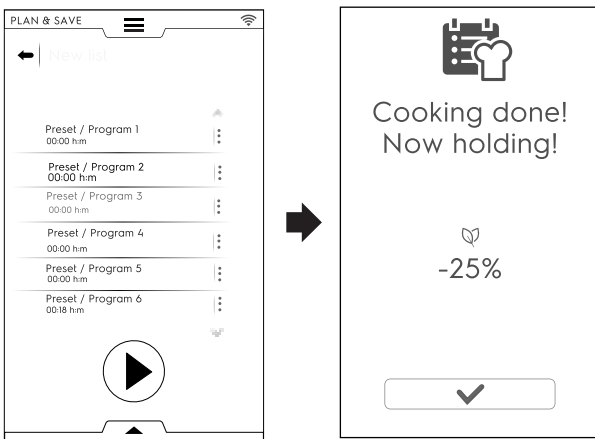

The oven starts the preheating. When the last cooking is performed an estimation of consumption reduction is displayed.

### Saving a list

- Open the lower drawer;
- Select Save list;
- Type the new name;

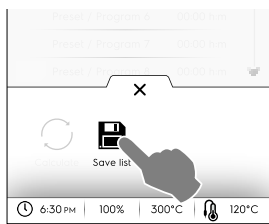

If the name of the new list already exists, a popup window appears to ask for overwriting or renaming it.

### Modifying a list order

- Touch the three dots of the row correspondent to the cooking to be moved;
  - Touch to move the item;
- A pop up message informs that this change cannot be saved.

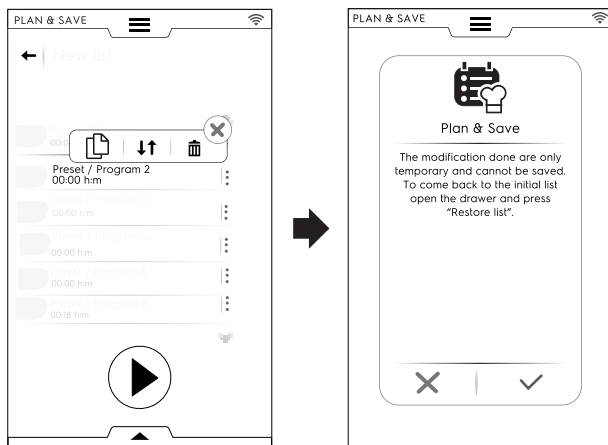

- All the remaining rows appear highlighted. Touch the row position where you want to move the cooking.
- To recover the initial list open the lower drawer and touch Restore list.

### Deleting an item list

- Touch the three dots of the row correspondent to the cooking to be deleted;

A pop up message informs that this change cannot be saved.

- Touch icon to delete the item;



To recover the initial list open the lower drawer and touch (Restore list).

- The list cannot be optimized again. Touch button to start the execution;

## F.14 SKYDUO/MATCH MODE (depending on your model - optional)

This option can be activated on demand. It works with a Wi-Fi or Ethernet connection, installed by an authorized technician and allows you to connect the oven and a blast chiller.



### IMPORTANT

Make sure you have the SkyDuo/Match option activated in both appliances. Only an authorized technician can install and activate the SkyDuo/Match option.

When the SkyDuo/Match icons are green in both appliances (see figure below), the connection works properly.

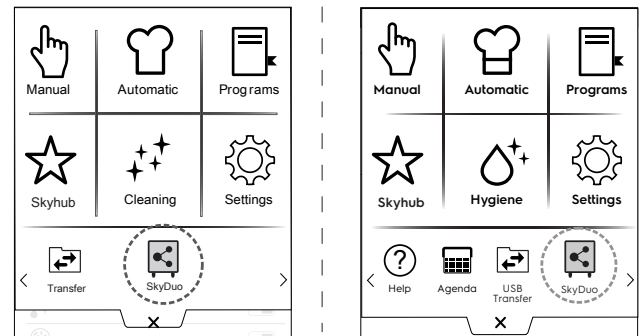

To disable (or enable) SkyDuo/Match touch the green icon and then touch the icon / on the display to change SkyDuo/Match status.

The synchronization process can start from any of the two appliances (caller and recipient).

The search for a similar program between the two appliances considers any program that contains at least **one word** present in the caller program's name. The recipient proposes all the cycles that meet these criteria.

It is possible to combine the SkyDuo/Match both in Automatic and in Programs mode.

### AUTOMATIC MODE

- Select for example a cooking cycle in the Automatic mode of the OVEN;

A. Select the food type (for example Meat)

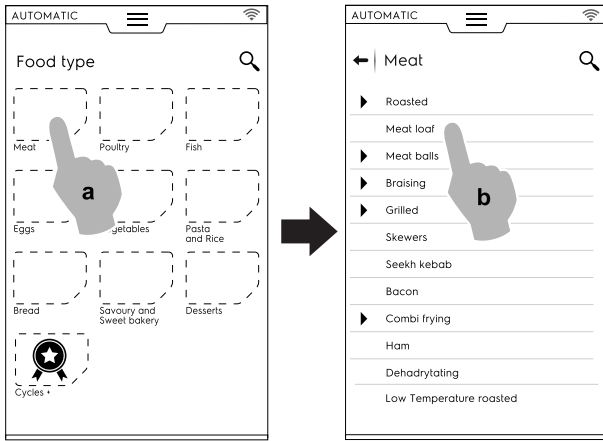

B. Select the required food cooking (for example Meat loaf)

C. Select cooking parameters, if present;

In this case select the Browning level and the probe temperature.

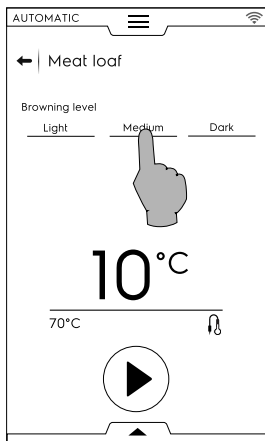

D. Start the cycle;

- The OVEN, connected with the blast chiller, has found a paired cycle in the blast chiller;  
Select the required cycle (for example X-chill) and confirm;

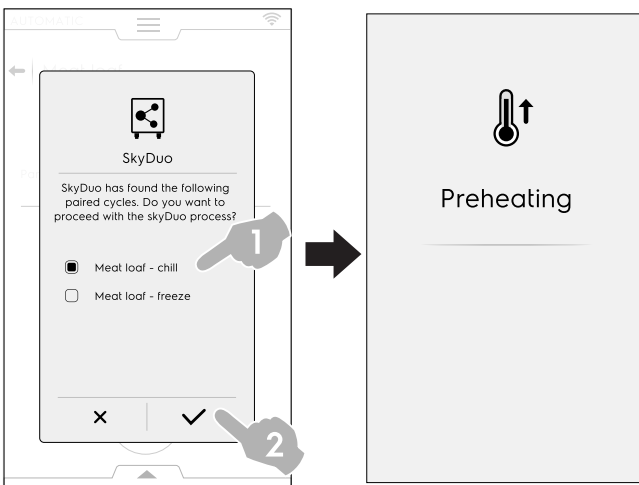

- The BLAST CHILLER asks how to proceed; it is possible to:

- Abort the process: touch the **X** to stop the process.

- Postpone the process of synchronization: touch the icon  to postpone the connection with the oven.

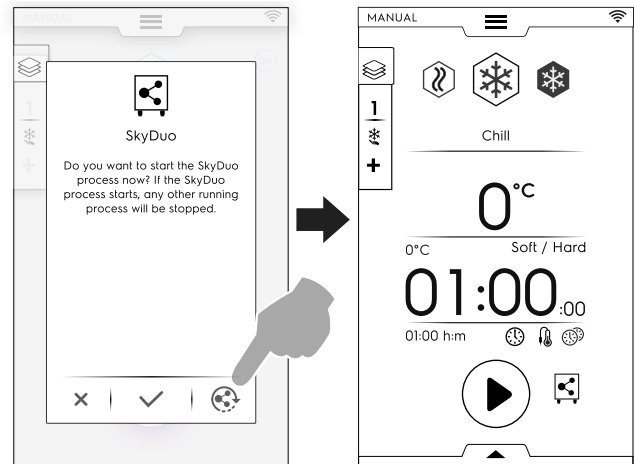

- Confirm the synchronization: touch the icon  to start immediately the SkyDuo process in the blast chiller. Any other running process will be stopped.

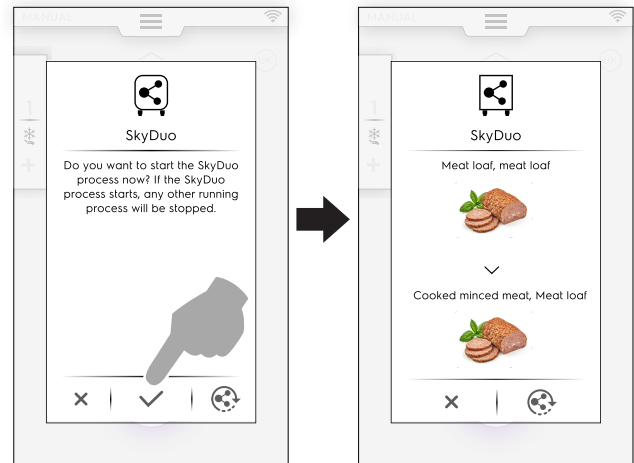

**NOTE!**

If an automatic cycle hasn't a graphic associated in one of the appliances, it will be replaced by the icon .

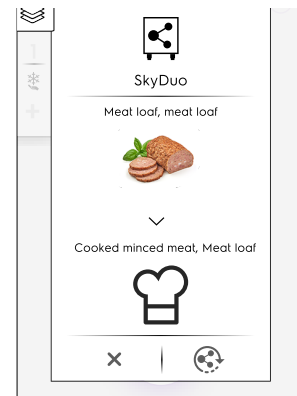

- Some minutes before the OVEN cycle ending, in the blast chiller precooling cycle starts to prepare the cavity for the food just cooked.

If you had postponed the SkyDuo process, some minutes before the end of the oven cooking cycle, a new pop-up with the request of synchronization will appear.

You can still confirm or postpone the process again.

## PROGRAMS MODE

1. Select a cooking cycle in the Programs mode of the OVEN (for example Red Meat);
2. Start the cycle;
3. The oven, connected with the blast chiller, proposes all the cycles that contain at least **one word** present in the blast chiller program's names; Choose the required cycle and confirm the selection;

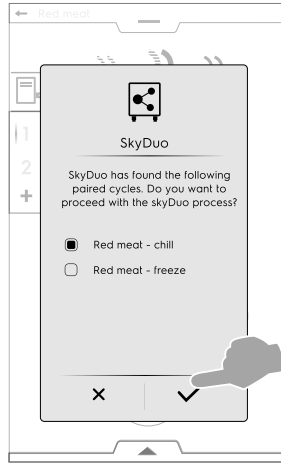

4. In the BLAST CHILLER; it is possible to:
  - Stop the process by touching the **X**.
  - Confirm the synchronization.
  - Postpone the process of synchronization by touching the icon

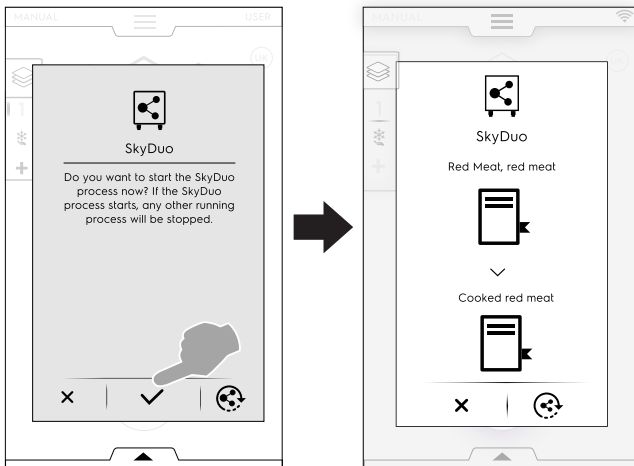

**NOTE!**  
If a programme hasn't a graphic associated in one of the appliances, it will be replaced by the icon

5. Some minutes before the OVEN cycle ending, in the BLAST CHILLER precooling cycle starts to prepare its cavity for the food just cooked.  
If you had postponed the SkyDuo process, some minutes before the end of the oven cooking cycle, a new pop-up with the request of synchronization will appear.

## F.15 HOOD MANAGEMENT

Once the hood is installed on the oven and enabled, the oven display will show some pop-up windows to remind that the hood maintenance is required after a period of working time.

This reminder can be skipped or, if the maintenance has been done by the Service, confirmed.

- To skip the pop-up window touch **X**.

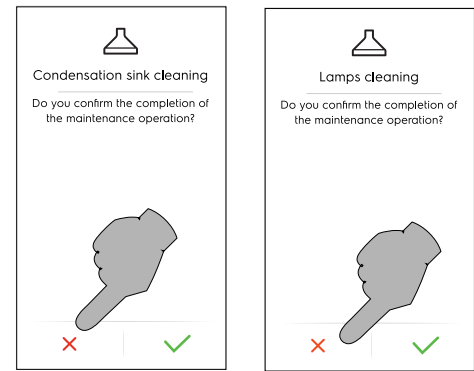

The reminders appear only after 7 days of continuous operation.

- It is possible to check how much time is left until the hood maintenance:

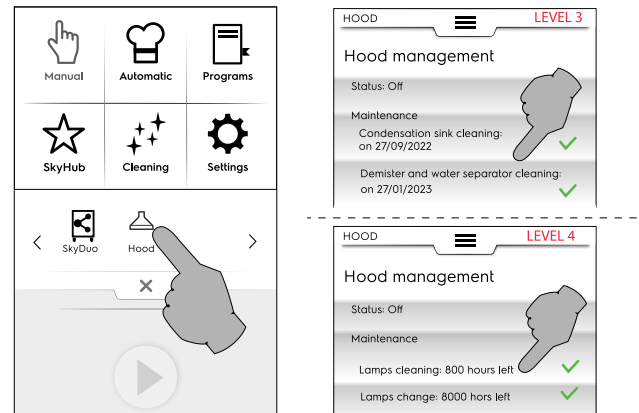

## F.16 CLEANING MODE

"Cleaning" function allows to clean the oven cavity automatically choosing the most suitable programme.



### IMPORTANT

To prevent material damage, injury or fatal accidents remove any object (trays, accessories,...), trolley excluded, from the oven cavity before the washing cycle.

1. Touch the cleaning icon and select the required cycle;

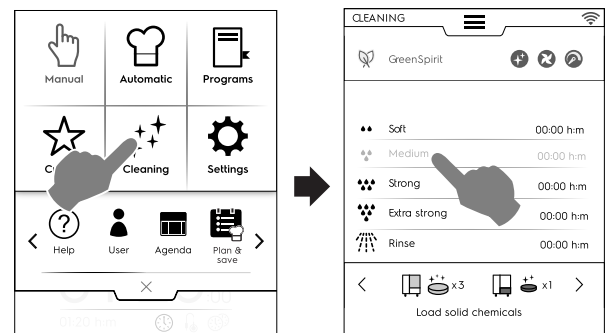

## FORCED COOLING

- If the cavity temperature is too high, the oven asks for proceeding to a forced cooling before starting any washing cycle.

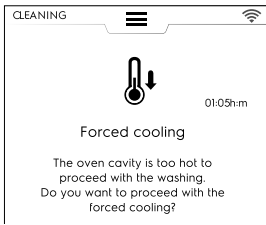

Touch ✓ button to confirm the cooling.

- If you do not confirm it, the cleaning cycles are not available. Press the button as shown in the figure to proceed with the cooling down.

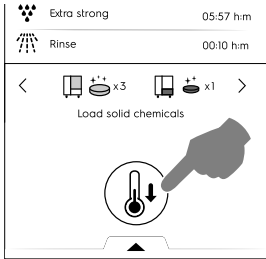

2. Touch the button ▶ to start the cycle;

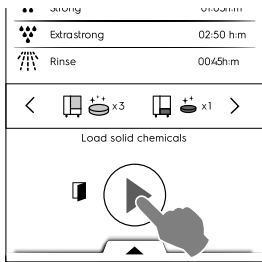

3. The display shows a message to remind you to REMOVE ANY OBJECT from the cavity (pans, trays, others!) or any accessories connected to the oven. Open the door and REMOVE ANY OBJECT from the cavity.

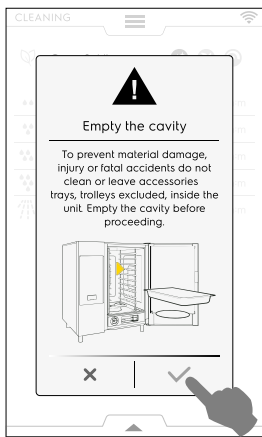

4. Touch ✓ to confirm that the cavity is empty.

5. The display shows a message asking for loading the various chemicals in the appropriate locations according to the selected cycle; put the cleaning agents into the centre bottom of the cavity or into the dedicated drawer (its position changes according to the model).

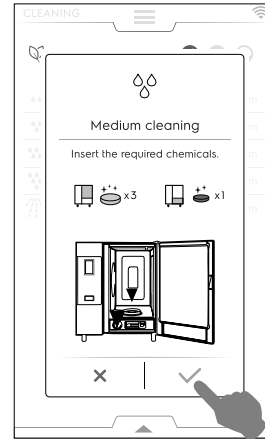

**NOTE!**

As for quantity, refer to the indications on the display.

6. Touch ✓ to confirm that the chemicals has been added.



**IMPORTANT**

If the cavity temperature is higher than 40 °C [104 °F] the oven will force the cool down prior to any cleaning cycle. **Put the cleaning detergent only after the cool down is completed as high temperature might trigger a chemical reaction!**

7. Close the door; the cleaning programme starts.



**IMPORTANT**

Do not open the door during the cleaning programme!

**Setting delayed start**

- Before touching ▶ button open the lower drawer and select the delay start icon.

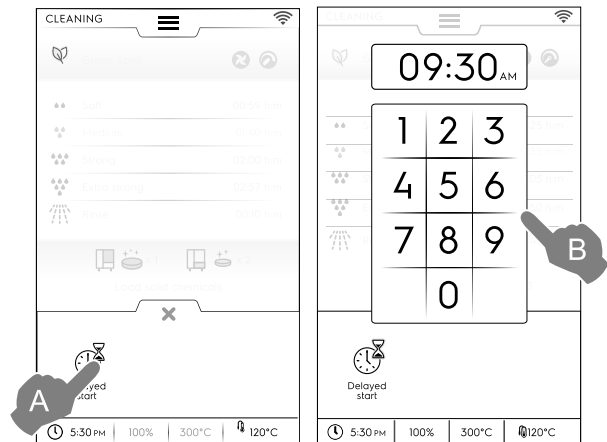

- Set the delayed start on the keypad. Touch ▶ to start the programme. Open the door, remove any object from the cavity and load the necessary detergent. Touch always ✓ to confirm the actions done. The delayed start is activated.



These screen is divided into the following areas:

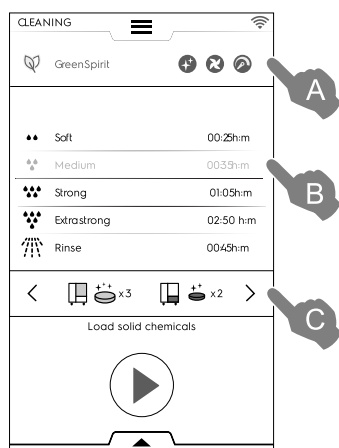

## Legend

A GREEN SPIRIT – ECONOMIZER area

B CLEANING CYCLES area

C DETERGENTS area

## A – GREEN SPIRIT – ECONOMIZER area (this function may not appear on the display)

The following functions allows you to reduce energy consumption and chemical impact to the environment.

- Activate this function to exclude the rinse-aid and descaling agent use;  
Skip Rinse Aid and Boiler Descale (**in the models with boiler**). Be aware that traces of scale might remain in the chamber and boiler.  
Skip Rinse Aid (**in the models without boilers – and in models that use liquid cleaning**).  
Be aware that traces of scale might remain in the chamber.
- Activate this function to skip the drying phase; – Skip Drying Phase  
Please open the door after cleaning to allow the oven to ventilate.
- Activate this function to reduce chemicals use; – Time to save  
Be aware that the timing will be extended in order to maximize the effectiveness of the cleaning with reduced consumptions.

## Green Spirit/Economizer setting

Activate the required function as shown in the example figure:

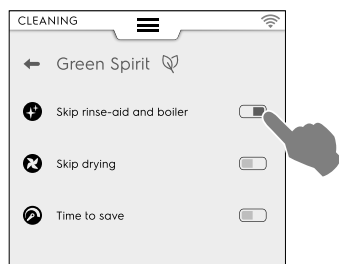

## B - CLEANING CYCLES area

Soft	Cleaning for low dirt level, i. e. steaming, baking or single loads with cooking temperatures lower than 200°C
Medium	Cleaning for medium dirt level, i.e. steaming, baking or single loads with cooking temperatures lower than 200°C
Strong	Cleaning for medium-high dirt level with roasted and grilling deposits
Extra Strong	Cleaning for high dirt level with heavy roasted and grilling deposits from multiple loads
Rinse	Rinsing with cold water

Cleaning time can vary from 10 minutes up to about 3 hours depending on the complexity of the cycle and the on oven size. The oven will display the duration of each cycle.

## C - DETERGENTS area

- Touch “<” or “>” (forward / back) to select the detergent type to use.



### IMPORTANT

To ensure best cleaning results, as well as to protect the oven with the cleaning programs, use the detergents, rinse aid and descale agents approved by Electrolux Professional, which already comply with fluid category 3, as per current regulations and legislation.



### IMPORTANT

Use only original or recommended maintenance/cleaning products. Cleaning agents being not original or not recommended by Electrolux Professional can seriously damage the appliance. Damages caused by using different cleaning and care products than those recommended by the manufacturer are excluded from the warranty. Wrong cleaning chemicals could leave behind chemical residues in the cooking chamber and/or create strong chemical reactions with severe consequences inside the cavity, which in worse cases may turn into explosion.

## DETERGENTS

### Standard configuration



SOLID detergent

Open and empty the number of sachets indicated on the display into the drain filter in the centre bottom of the cavity;



### IMPORTANT

Electrolux Professional approved cleaner: C22 Cleaning Tab (where available) or C23 Cleaning Powder.

### Alternative configuration – detergents



LIQUID detergent in containers (accessory, on demand)

The optional accessory EXTERNAL CONNECTION KIT FOR DETERGENT/RINSE AID is required (on demand); the oven will automatically use the right amount of chemicals according to selected cycle.



### IMPORTANT

Electrolux Professional approved cleaner: C20 Extra Strong detergent (Check local availability).

## RINSE AID

### Standard configuration



SOLID rinse & descale in tablets

Open and empty the number of tablets indicated on the display to the front drawer under the oven cavity.

Descalce effect available only in models with boiler.



#### IMPORTANT

Use only C25 Rinse and Descalce tabs by Electrolux Professional.

### Alternative configuration – rinse aid



LIQUID rinse aid in container (accessory, on demand)

The optional accessory EXTERNAL CONNECTION KIT FOR DETERGENT/RINSE AID is required (on demand); the oven will automatically use the right amount of chemicals according to selected cycle.



#### IMPORTANT

Electrolux Professional approved rinse aid: C21 Extra Strong rinse aid (check local availability).



#### NOTE!

The default chemical displayed can be changed according to the type of detergent used. This setting can be modified in the Settings mode => “Service” area.

### Detergent loading

#### 6 - 10 GN model

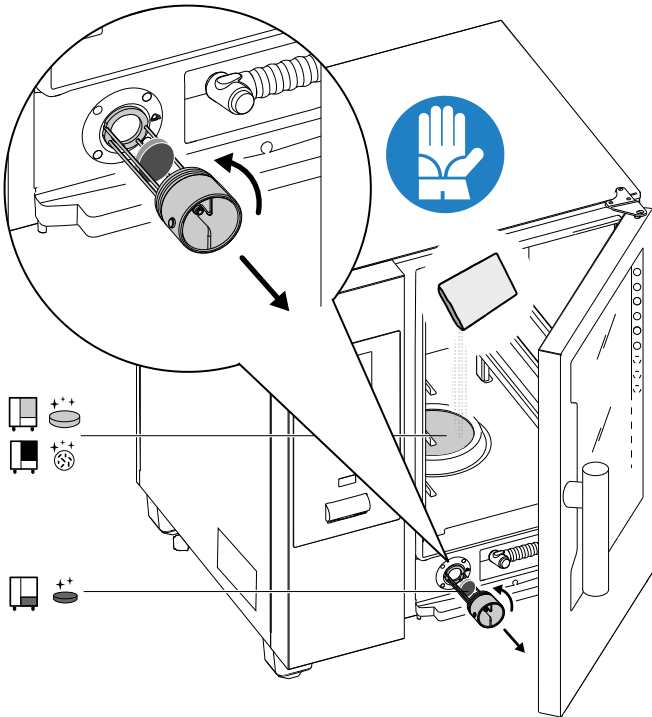

#### 20 GN model

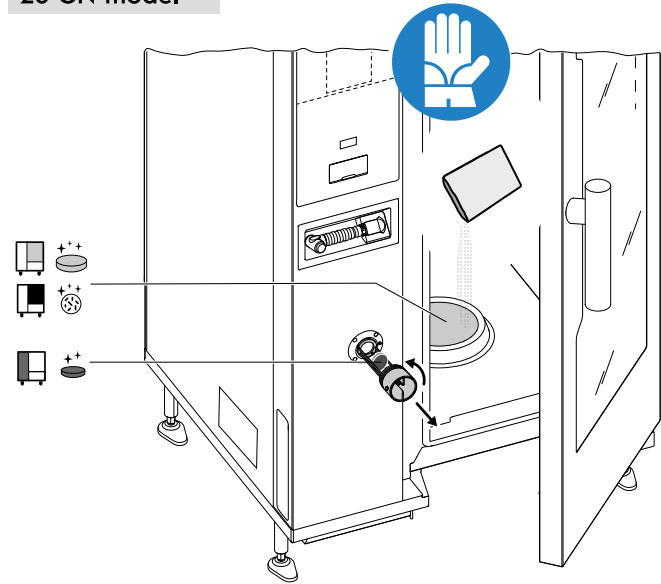

#### IMPORTANT

In 20 Grids models run the cleaning cycles only with trolley inside the oven. It helps the sealing in closing the bottom openings between the cavity and the door.



#### WARNING

To prevent material damage, injury or fatal accidents do not clean or leave accessories/trays (trolleys excluded) inside the unit. Empty the cavity before proceeding.



#### IMPORTANT

Do not use detergent or rinse aid powder dissolved in water or in gel form and/or containing chlorine.



#### WARNING

Both chemical substances and hot steam can escape from cavity with risk of burns and scalding. Use Gloves.

Always refer to the safety cards and labels on the products used.



#### WARNING

Do not start any cooking cycle if the cleaning cycle has not been completed and/or after cleaning cycle completion if there are still detergent residuals, if any.



#### WARNING

Do not open the cooking cavity door while cleaning cycle is operating.



## WARNING

In case of steam leakages from the cavity door and/or visible wearing or damage of cavity door gasket, do not start any cleaning cycle.

Call the Customer Care Service.

### Special conditions – Display status

#### • Running cycle

During the cycle the display shows:

- the remaining time
- the duration of the set cycle

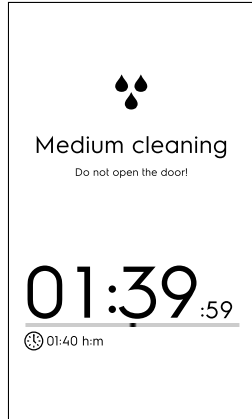

#### • Cycle stop

Keep hold  button to stop the cycle;

The Stop button will be available only when the program is running. After the selection the display will show the remaining time for rinsing the cavity and the boiler.

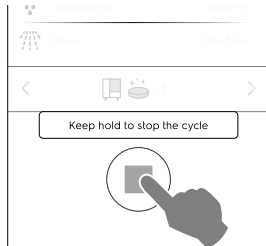

#### • Forced rinse

If you have stopped a running cleaning cycle, the appliance may proceed to perform a forced rinse to wash out all the chemicals from the cavity.

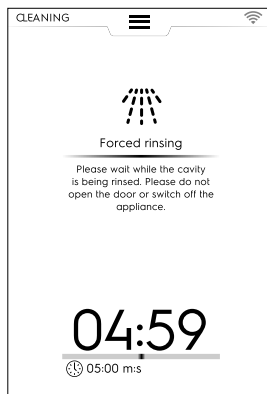

During this time the door cannot be opened.

### End of cycle

- **Cleaning done: info on consumptions** (see example in a Gas model, the data are purely indicative).

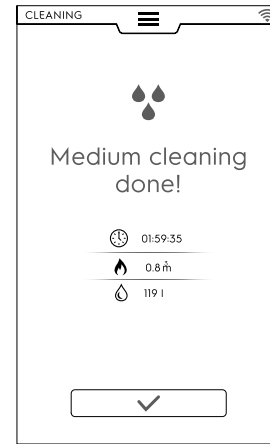

The display may show up a message about an anomaly with chemicals loading during the cleaning cycle. In this case:

- verify if there are undissolved tablets in the cleaning drawer;
- if present, remove them before using the oven for cooking.

### Legenda



Electric consumption in kWh



Gas consumption in m<sup>3</sup>



Water consumption in litres



Detergent consumption in tablets



Rinse-aid consumption in tablets



Detergents consumption in litres



Descaling agent consumption



Time consumption in hours : minutes : seconds

### F.16.1 FORCED CLEANING

This function measures the oven cooking time elapsed from the last automatic cleaning cycle. If the limit is reached (the default value is 24h), no further cooking cycle is allowed.

- The display shows the pop-up window “Forced cleaning”: it is necessary to perform one of the automatic cleaning cycles.

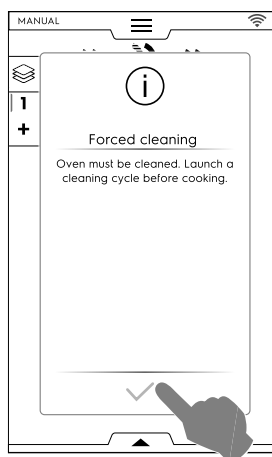

- At the conclusion of the selected cleaning cycle, the pop-up window disappears; the cooking functionality is now restored.

To enable/disable this function and/or change the time limit to force a cleaning see *Cleaning – Advanced functions* section in F.17 **SETTINGS** chapter.

### F.16.2 BOILER DESCALING

During the routine washing cycle with solid chemicals (Rinse and Descale blue tabs) the boiler is maintained scale free. However, in case of excessive scale in the boiler the display may show a message with “dESC” error code signalling the need to carry out a descaling.

- Run a cleaning program including the rinse and descale cycle and use 2 tabs “C25” only for 6-10 grids models and 3 tablets only for 20 grids models instead of the usual quantity.



#### IMPORTANT

When performing the cleaning cycle with 2 tablets (or 3 tablets depending on the model) of “C25” do not activate GREEN SPIRIT – ECONOMIZER function.



#### IMPORTANT

Always skipping the Rinse Aid and Boiler Descale phase may lead to lime build up in the boiler. After a certain time, the oven disables this feature and asks for a complete cleaning programme with solid chemical in order to descale the boiler.

- If, after carrying out the cleaning cycle, the display shows a message about boiler maintenance, call Service.

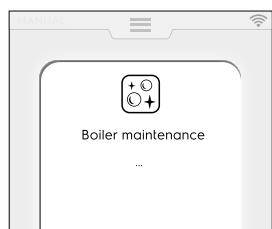

The specialized personnel will descale the boiler by means of a dedicated cycle.



#### IMPORTANT

The manufacturer declines any liability if these prescriptions are not respected; Also, the warranty does not cover the repair or replacement of components damaged by scale whenever the required supply water characteristics are not respected.

## F.17 SETTINGS

“Settings” mode allows to change some usage parameters of the oven.

- Open the upper drawer and select Settings;

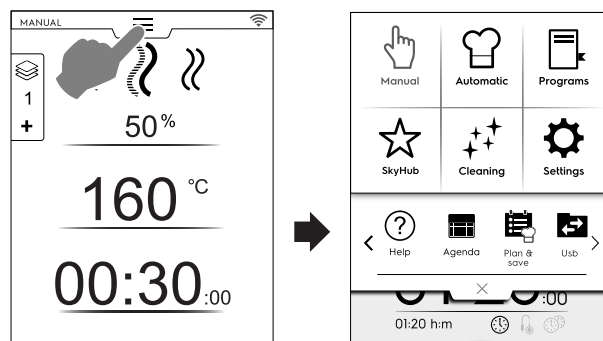

- The display shows the main menu with ALL SETTINGS;

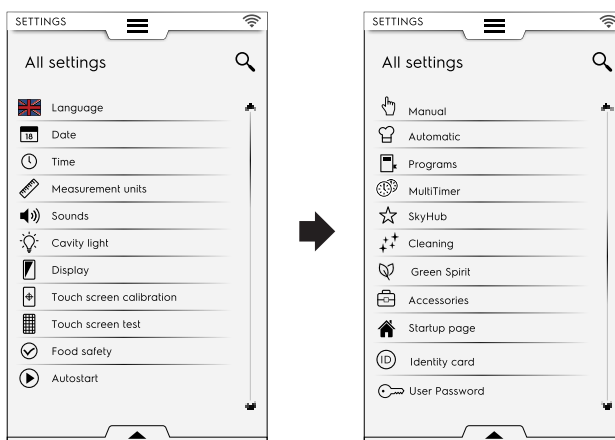

### Default setting

If it is required to restore the factory setting, proceed as follows:

- Open the lower drawer and select the related icon;

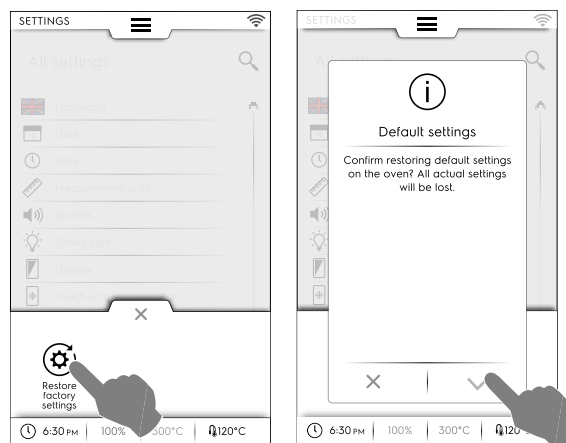

- Confirm restoring to close the pop-up window.

### F.17.1 LANGUAGE



#### Language

This parameter allows to customize all menus in the selected language.

- Touch the flag icon;
- The display shows all settings in the required language.



### F.17.2 DATE



Date

This setting allows to set the current date.

- Set the date format (D/M/Y, D/M/Y, Y/M/D)
- Enter the date: touch “<” / “>” to select the month and year and touch the corresponding number on the calendar to select the day.



### F.17.3 TIME



Time

This setting allows to set the current time.

- Set the time format (24H or AM/PM)
- Enter the time: touch the corresponding number on the keypad.



### F.17.4 MEASUREMENT UNITS



Measurement units

- This setting allows to set the temperature measure unit (°C or °F).

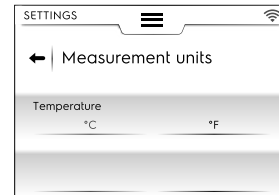

### F.17.5 SOUND



Sound

This setting allows to set:

- the volume level from “0” to “10”;
- enable / disable the End-cooking sound (☑ / ☐);
- choose and set the “End-cooking” jingle.

### F.17.6 CAVITY LIGHT



Cavity light

This setting allows to enable / disable the cavity light (☑ / ☐)

- Set the brightness from 0 to 100 %;
- Enable / disable the end-cooking blinking light;
- Enable / disable the Alarm blinking light;
- Enable / disable the Preheat blinking light.

### F.17.7 DISPLAY



Display

This setting allows to:

- adjust the brightness of display from “0” to “100”%
- set the sleep timeout value (minutes/seconds).

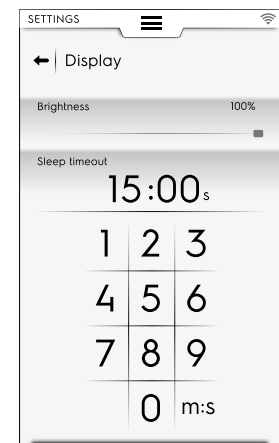

### F.17.8 TOUCH SCREEN CALIBRATION



Touch screen calibration

This setting allows to set the calibration of the screen.

1. Touch different points on the screen to check calibration accuracy;
2. Touch and hold to exit;

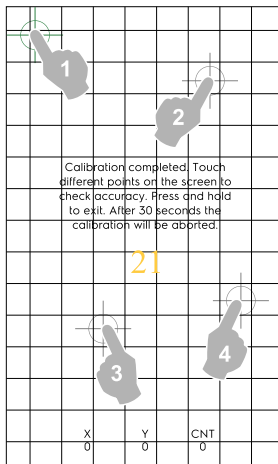

### F.17.9 TOUCH SCREEN TEST



#### Touch screen test

1. Touch the screen as close as possible to the centre of the red cross;
2. Repeat until the cross turns green;
3. Touch  to exit;

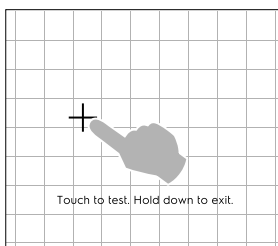

### F.17.10 FOOD SAFETY



#### Food safety

This setting allows to enable / disable (  /  ) the following parameters:

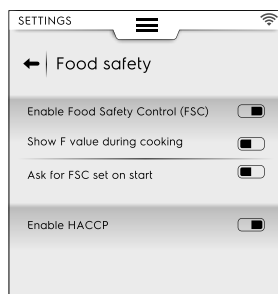

#### Food Safe Control (FSC)

The FSC feature guarantee the microbiological safe condition of the food. If the FSC function is enabled it will be possible to:

- Enable/disable the visualisation of the "F" factor;
- Enable/disable asking for FSC set on start.

### HACCP

- The HACCP feature allows the storage of all the set values identifying a cooking process, and their variation, the cavity temperature and, when used, the food core temperature at specific intervals.

### F.17.11 AUTOSTART



#### Autostart

This setting allows to enable / disable (  /  ) the Autostart feature in all modes.



The Autostart function allows the start of the selected program by closing the oven door.

### F.17.12 MANUAL



#### Manual

This setting allows to enable / disable (  /  ) the Manual cooking mode and its options:

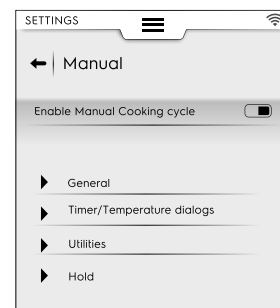

#### NOTE!

If a mode is disabled, it is not visible in the upper drawer.

#### General

- Show real and set values. The activation allows to display the cycle with more detailed information: humidity, temperature and time are shown as current and set values.
- Always show food probe temperature. It allows to display the probe temperature values.
- Cooking preheating. It allows the oven to perform the preheating/precooling phase.
- Advanced preheating. This activation allows to set a temperature to be reached in preheating/precooling phase. Touch the temperature row and set the required value.
- Delayed start preheating. This activation allows the oven preparing the cavity for the delayed cooking cycle.
- Multi-phase cooking. It allows the oven to perform Multi-phase cooking cycle.

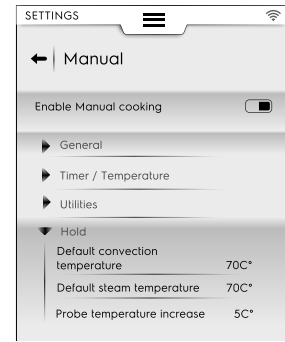
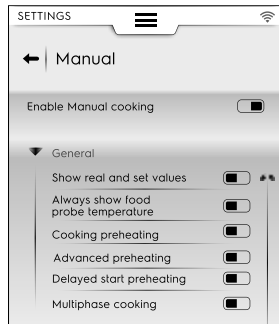

### Timer/Temperature dialogs

- Short cooking. The activation enables the short cooking feature showing up.
- Eco-delta cooking. The activation enables the Eco delta cooking feature showing up.
- Minimum cavity-probe temperature difference. Touch to set the minimum value on the appearing touchpad (e.g. 5°C).

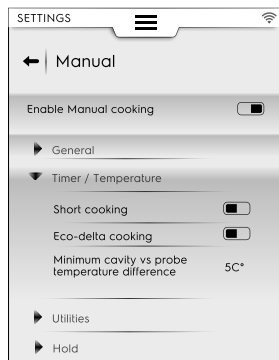

### Preferred Cooking cycles

Choose the cycle proposed by the oven when selecting the Manual mode.

- ≡ Convection
- ≡ Combi
- ≡ Steam

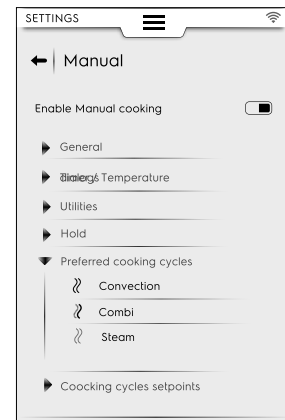

### Utilities

- Cooking info in option drawer. The activation allows information showing up in the drawer.
- Delayed start. The activation allows to postpone a cycle at a more convenient time.

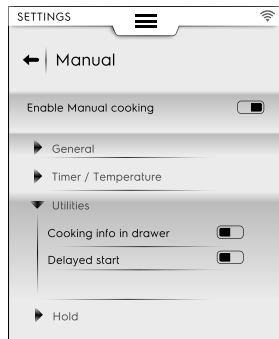

### Cooking Cycles setpoints

You can choose the default setpoints values of the cycles:

- Edit Convection setpoints. Change the values more convenient for your default Convection cycle.
- Edit Combi setpoints: Change the values more convenient for your default Combi cycle.
- Edit Steam setpoints. Change the values more convenient for your default Steam cycle.

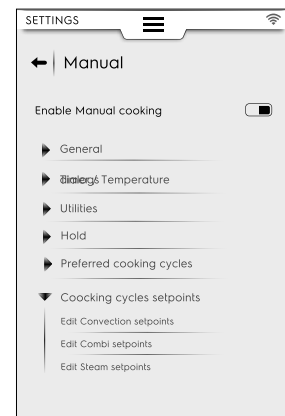

### Hold

- Default convection temperature 70°. Touch the value to set the required temperature on the appearing keypad.
- Default steam temperature 70°. Touch the value to adjust the default temperature on the appearing keypad.
- Probe temperature increase 5°. Touch the value to adjust the probe temperature on the appearing keypad.

## F.17.13 AUTOMATIC



Automatic

This setting allows to enable / disable (  /  ) the Automatic cooking and the related cycles.



**NOTE!**  
If a mode is disabled, it is not visible in the upper drawer.

### Enable step view

- This setting allows to show or hide the steps of an automatic cooking cycle.

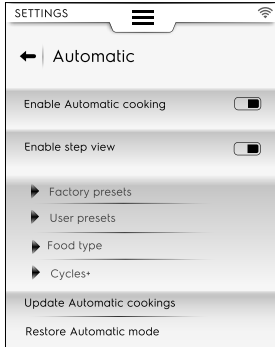

### Factory presets

- This setting allows to save and/or overwrite the factory presets that you have modified.

### User presets

- This setting allows to save and/or delete the presets completely created by you.

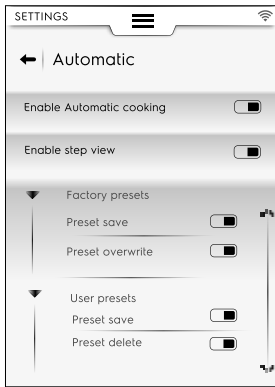

### Food type

- This setting allows you to display or hide each type of food on the display.

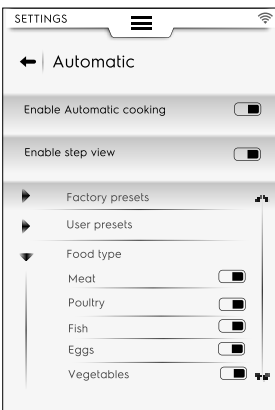

### Cycles+

- This setting allows each automatic cycle to be displayed or hidden in the display list.

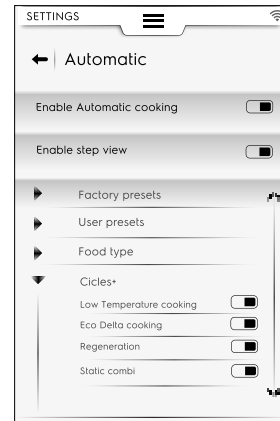

### Update automatic cookings

- This setting allows to updated the automatic cycles stored in your oven with the latest ones. Use an USB pendrive.

### Restore automatic cooking

- This setting allows to restore the automatic cycles before last update.

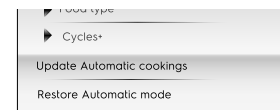

**NOTE!**  
To update and/or restore the automatic cycles, follow the instructions given in F.7.2 *UPDATE/RESTORE AUTOMATIC CYCLES* paragraph in F.7 *AUTOMATIC MODE* chapter.

## F.17.14 PROGRAMS



### Programs

This setting allows to enable / disable (  /  ) the Programs mode and the related functions.

The functions are divided into General, Local Programs and Cloud Programs:

#### General

- Enable management from Cloud. It enable to download/ manage programs from Cloud.
- Enable messages in Programs. It allows messages displaying during a running.
- Enable skip preheat. It allows to skip the preheating phase.
- Show categories. This activation allows food categories to show up on the display.
- Show most used. It allows most used programs to show up on the display.



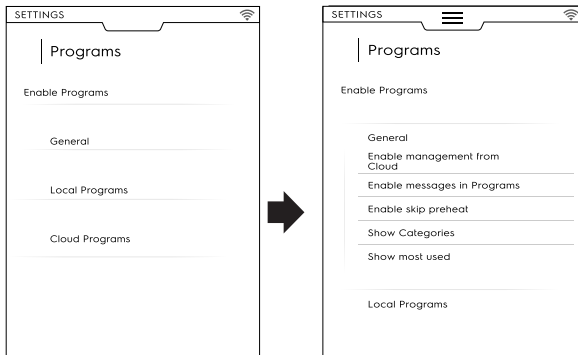

### Local Programs

- Programs delete. It enable the “delete programs” function.
- Enable Programs modify. It allows to “modify programs”.
- Enable Programs save. It allows to “save program”.
- Programs overwrite. When saving, it allows to overwrite programs with the same name.

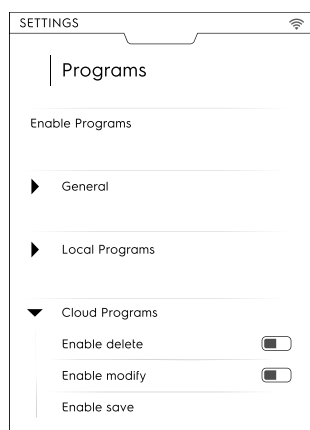

### Cloud programs

- Programs delete. It allows the “delete programs” function.
- Enable Programs modify. It allows to “modify cloud programs”.
- Enable Programs save. It allows to “save cloud programs”.

### F.17.15 MULTITIMER



#### MultiTimer

This setting allows to enable / disable (  /  ) the MultiTimer feature.

Once activated, it is possible to:

- enable/disable MultiTimer programs to show up on the display;
- enable/disable temperature recovery inside the cavity.

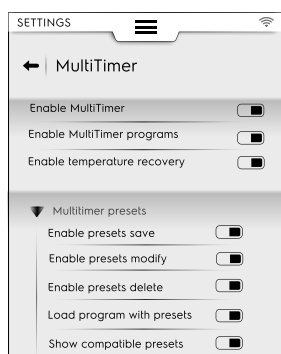

This setting allows to enable / disable MultiTimer presets functions:

- Enable Presets save. It allows “save preset” function;
- Enable Presets modify. It allows “modify preset” function;
- Enable Presets delete. It allows “delete preset” function;
- Load programs with presets. When a MT programme is recalled, all the presets associated are automatically loaded.
- Show compatible Presets. When selecting presets for a program, all the compatible presets are shown.

### F.17.16 HOMEPAGE FAVORITE MODE



#### Homepage favorite Mode (SkyHub/SoloMio)

This setting allows to enable / disable (  /  ) the Homepage Mode (SkyHub/SoloMio).

Once enabled, it is possible to:

- enable/disable the SkyHub management (create/save links and pages).
- reset the SkyHub ambient. All saved links and pages will be deleted.

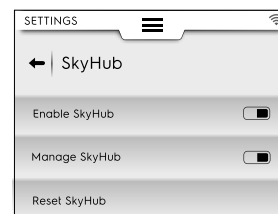

### F.17.17 CLEANING



#### Cleaning

This setting allows to enable / disable (  /  ) the Cleaning feature and the related cycles and functions:

#### Default cycle

- This setting allows to set the default cycle when selecting the cleaning mode from the upper drawer;

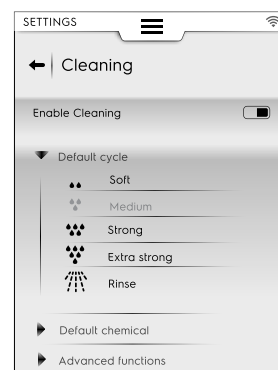

#### Default Chemical

- This activation allows choose the detergent format:
  - Solid
  - Liquid (if enabled kit for External liquid detergent)
  - Powder

## Cleaning – Advanced functions

- Forced cleaning after [xx]:[xx] H:M...

This setting allows to enable/disable (  /  ) the function of a forced cleaning after a settable cooking time.

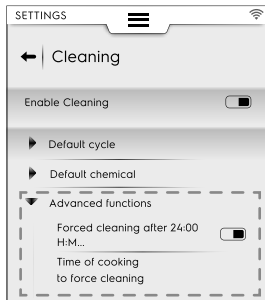

- Time of cooking to force cleaning

Set the desired time on the appearing keypad. The default value is 24:00 H:M.

## F.17.18 GREEN SPIRIT/ECONOMIZER



### Green Spirit/Economizer

This setting allows to enable / disable (  /  ) the “Saving options“:

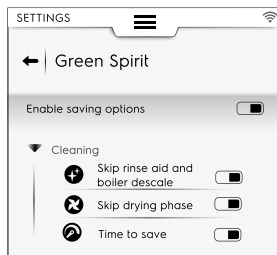

## Cleaning options

	Skip rinse-aid and boiler descale. It allows to skip the rinse aid phase and descale the boiler.
	Skip drying phase. It allows to skip drying phase.
	Time to save. It allows to shorten the cleaning time.

## F.17.19 ACCESSORIES



### Accessories

This setting allows to: enable / disable (  /  ) the following feature/options:

SkyDuo/Match	If available in your model
	USB food probe
	Cleaning with Liquid chemicals

## F.17.20 STARTUP PAGE



### Startup page

When the oven is switched on the default startup page is Manual mode.

- This setting allows to set a different environment for the starting page. Select the required environment.

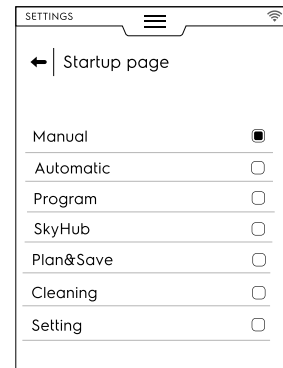

## F.17.21 IDENTITY CARD



### Identity Card

- This page shows the technical data of your oven together with the latest uploaded versions of: software, system, cleaning files, automatic cooking, ACU Firmware, all licenses related to the SW and connectivity board type.

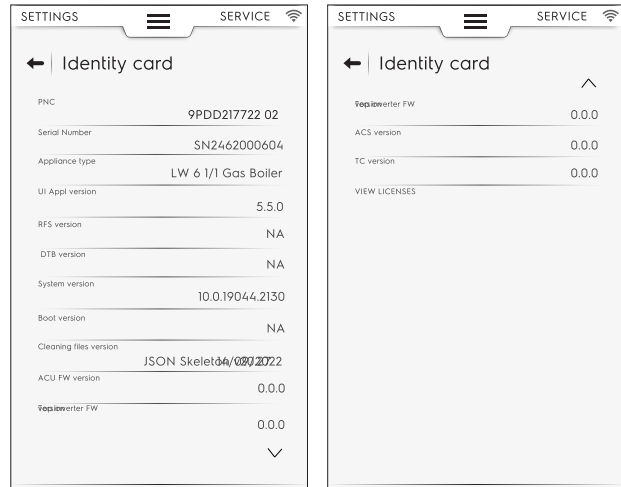

## F.17.22 USER PASSWORD



### User Password

- This setting allows to set a password to access into specific environments, features and options to prevent setting changes.

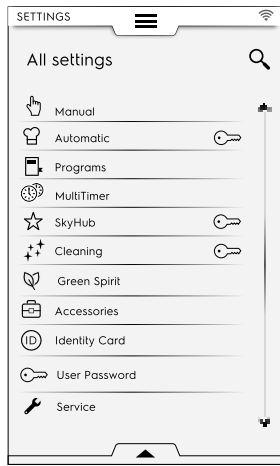

If the password is forgotten, contact the Service.

### F.17.23 SERVICE



#### Service

- This environment is only allowed to an authorized technician.

### F.18 SWITCH THE OVEN OFF

Press the "O" side of the button "O – I" to switch the oven off.

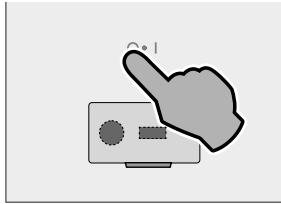

#### IMPORTANT

Before switching off, the appliance executes a cavity drying: the cooling fan remains active at the maximum speed to cool down the components compartment and to dry the oven chamber. A popup message asks to OPEN THE DOOR, and to confirm its opening.

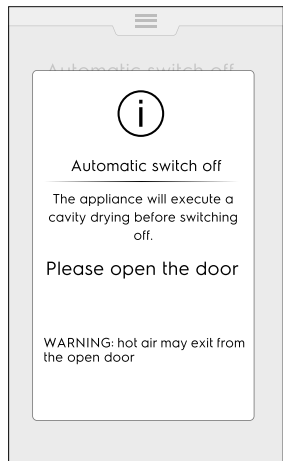

- If the oven door is opened, the drying procedure starts with a 5-minutes countdown. Then, the oven switches off.

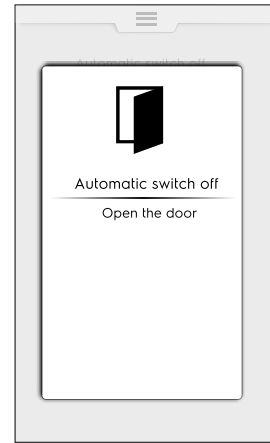

- If the door is still closed, the pop-up message remains visible for about 30 minutes, then the oven switches off.



#### IMPORTANT

This procedure does not start if the oven has only been used for "browsing", i.e. changing parameters, updating software, and so on.

## G OVEN CARE



### WARNING

Refer to “*WARNING and Safety Information*”.

#### G.1 Care information

Care operations have to be carried out by the owner and/or user of the appliance.



#### IMPORTANT

Problems resulting from poor or lack of care as hereinafter described will not be covered by the warranty.

#### G.2 Cleaning introduction

#### G.3 Appliance cleaning

Your oven is subject to soiling every time it is used for cooking: the type of soiling and its location in the oven depend on many factors. Hereafter, you will find information about the location of the parts to be cleaned and how often they should be cleaned.

#### G.4 Cooking chamber

It is suggested to clean it at least once a day in case of daily use: it could happen, with particular types of cooking, to have to clean it even more than once a day.

To clean the cooking chamber, use the dedicated programs as explained in F.16 *CLEANING MODE* paragraph.

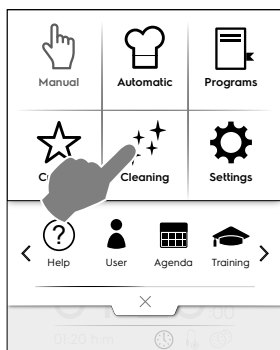

#### G.5 Boiler or steam generator (models equipped only)

It is suggested to descale it every day in case of daily use.

The descaling cycle is included in the same washing programs as the cooking chamber, with the exception of the rinsing program. Make sure to add the specific tab as explained in F.16 *CLEANING MODE* paragraph.

Using the ecological “Green Spirit/Economizer” feature excludes the descaling of the steam generator, which over time leads to the accumulation of limescale. When the oven shows the message “dESC”, descale as indicated in the instructions in F.16.2 *BOILER DESCALING* section of the above paragraph.

#### G.6 Cooking chamber filter

This filter is clearly visible in the centre of the bottom of the cooking chamber and is used to prevent damage to the washing pump and/or to avoid obstructions in the washing circuit.

**Once a week:**

1. Undo the screw from the centre of the filter;

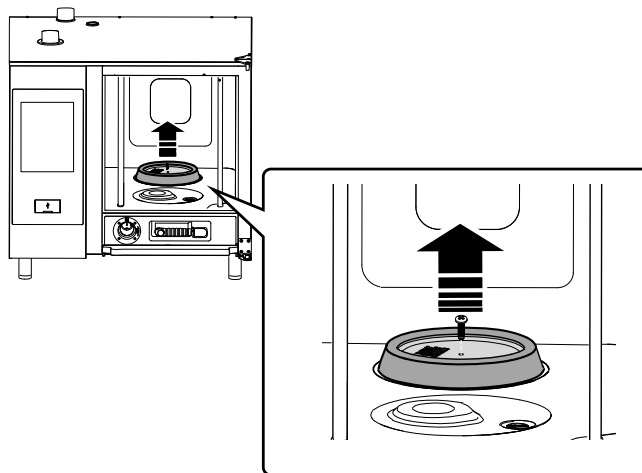

2. Remove the filter from its housing;
3. Wash the filter in the dishwasher with a gentle programme; in other cases, wash the filter by hand with neutral dish washing detergent and rinse thoroughly;
4. Refit the filter in its place and screw the central screw to fix it.

#### G.7 Air filter

It is a polyurethane sponge, housed in a support equipped with slits for the inlet of the cooling air of the oven components (see figure for “table-top” models for example).

It avoids that the impurities of the kitchen environment (oils, greases, flours, powders,...) are transported on the internal components causing malfunctions.

**Once a month:**

1. Unlock the filter support by unscrewing the screws and remove it;

The pictures refer to 6-10 GN model

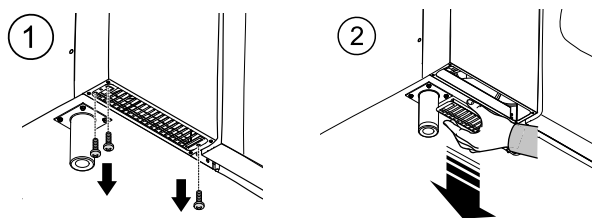

2. Remove the filter and degrease it by washing it with dish detergent;
3. Dry the filter and put it back in the support;
4. Put the support back in place. If necessary, depending on your model, secure it with the screws.

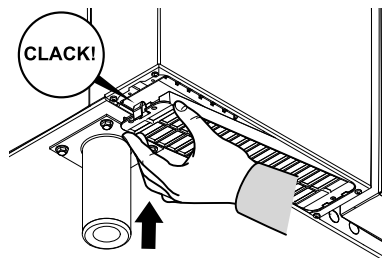



**IMPORTANT**

For safety reasons, the oven is equipped with a mechanism to detect the presence of the filter support. If the filter is not refitted, a message is given indicating that the filter should be put back in place. After 8 hours of operation without a filter, the oven will freeze until the support is refitted.

**G.8 Door gasket**

The silicone gasket that surrounds the cooking cabinet facade is an essential element in achieving the desired cooking results and preventing air, water or steam leakage during oven operation. The gasket is the most stressed element of the oven because it is subject to multiple types of stress: thermal, chemical, physical.

At least **once a day** (preferably after the washing cycle of the cooking chamber) carefully clean the facade and the gasket using a cloth soaked in water.



**IMPORTANT**

It is necessary to clean the gasket repeatedly during daily use, especially when cooking temperatures above 220 °C are used. Cleaning the gasket with a damp cloth during grilled cooking considerably increases the life of the gasket. Never use abrasive products to clean the gasket. Do not leave the oven cooking at high temperatures without a load.

Replace the facade gasket every six (6) months.

To replace it, proceed as follows:

1. Remove the gasket from its seat;
2. Clean the latter of any traces of dirt;
3. Insert the new gasket along the entire seat.

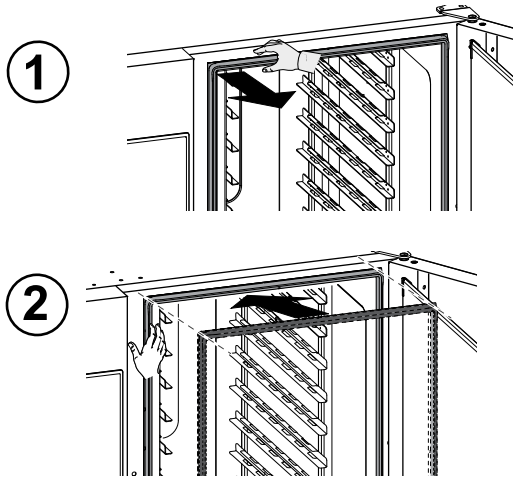

**G.9 Inner, outer and cooking chamber glass**

Keeping the glass mounted on the oven door clean is important for their dual role: shielding the user from the temperatures that develop in the cooking cavity and allowing visibility inside to ensure control of the cooking at all times.

**After each washing cycle** of the cooking chamber:

1. Clean the edge of the internal glass. See figure below;

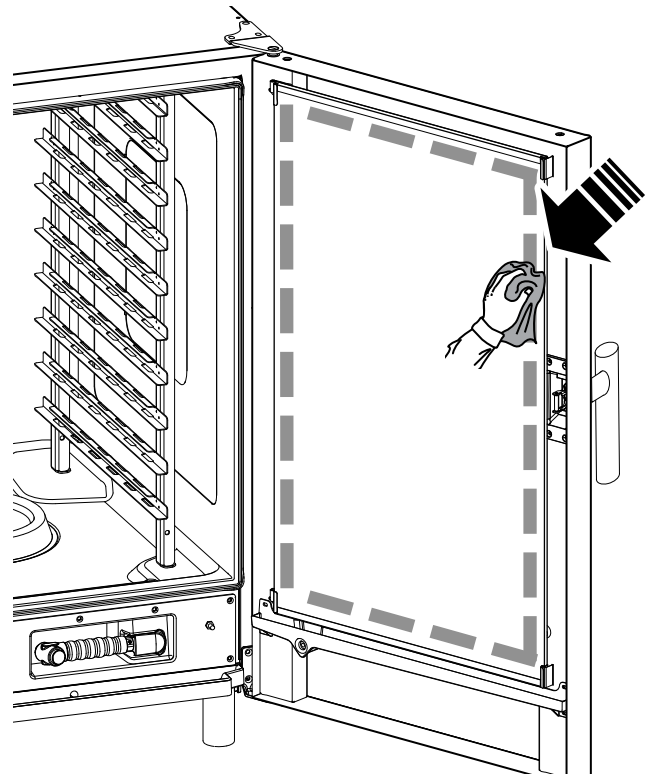

2. With the door open, press the two top and bottom retaining clips as shown in the figure to reach the interspace between the inner and external glass;

Clean the outer side of the internal glass door using a glass product;

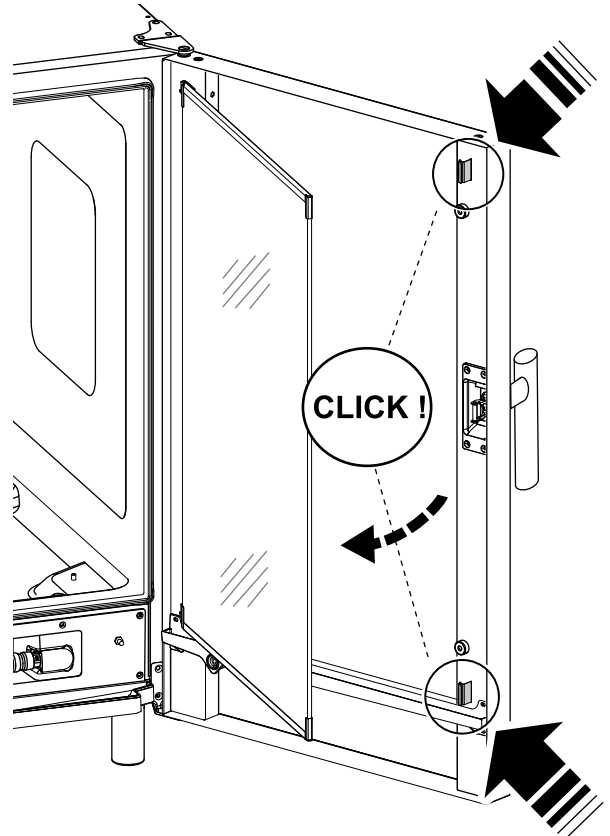

3. Clean then the interspace surfaces between the doors.

4. Refit the internal glass into the clips and close the oven door.

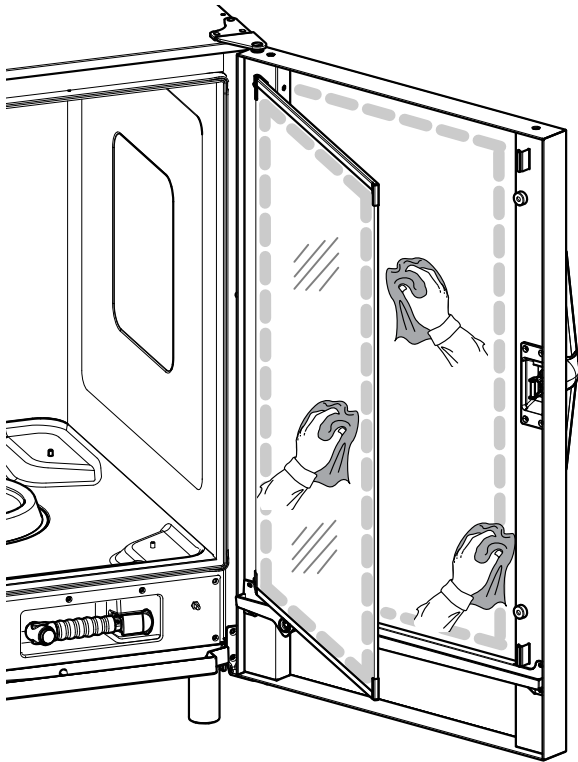

### G.10 Door area



#### IMPORTANT

It is strongly recommended to clean **each day** the area along the entire door perimeter, the rubber gasket and the internal glass especially near the edge.

After cooking cycle the oven door, its internal glass, the gasket and the area around the door perimeter may become easily dirty due to greasy vapours coming out from the oven.

These operations must be done with the door glass cold, without using abrasive detergents or rags.

1. Clean thoroughly the oven area along the door perimeter as indicated in the following figure:

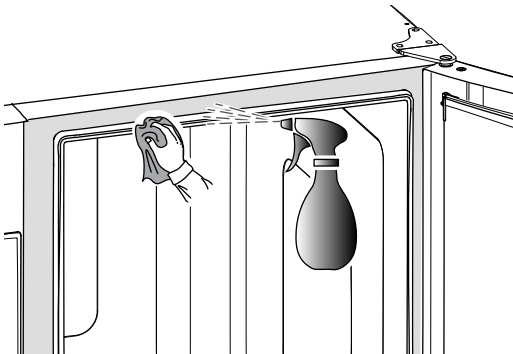

2. Clean along the rubber gasket;

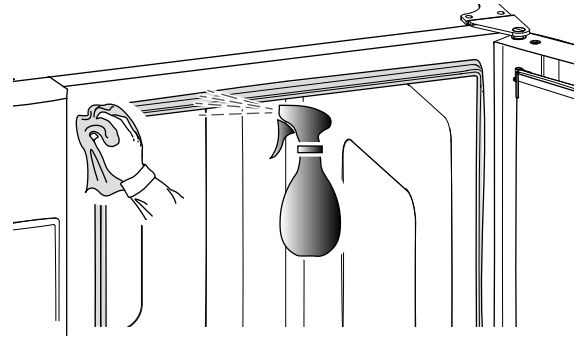

### G.11 Efficiency control of the discharge system

Residues released during cooking, despite regular cleaning of the cooking chamber, can encrust the external discharge pipe. It is therefore essential to check the efficiency of the discharge and to clean the external pipe as soon as there are signs of obstruction. At least **once a year**, clean the drain pipe.

### G.12 Condensate drip collector

The plastic drip collector at the bottom of the cooking chamber façade ensures that the steams that condense as soon as the door is opened are collected and discharged.

For hygiene reasons, clean it as follows:

1. Use water to clean regularly the drain pipe ("A") of the drip collector;

If the discharge is not uniform spray a neutral detergent solution and let it melt the incrustations before cleaning with water jet.

2. Remove the metal cover ("B") and use the same system to clean the single check valve ("C");

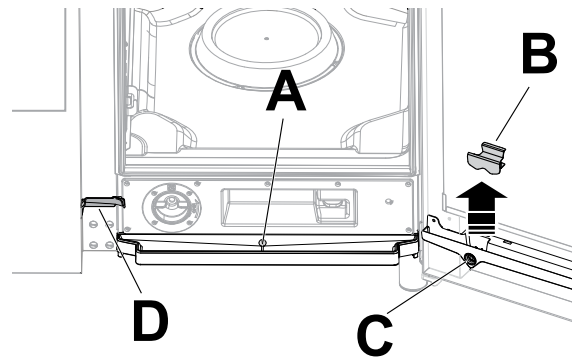

3. Use regularly a pipe cleaner with nylon bristles (supplied with the appliance, according to the model) to clean the small gutter ("D").

### G.13 Food probe

Residues released during cooking, despite regular cleaning of the cooking chamber, can encrust the food probe, altering the temperature detection.

To ensure optimal operation of the oven with the food probe, it is recommended to clean the food probe manually **every day**, using lukewarm water and neutral soap, avoiding tying the cable of the probe and rinsing with water.



#### IMPORTANT

Pay particular attention when handling the probe; remember that it is a sharp object, therefore handle it very carefully, even during cleaning.

## G.14 Other surfaces

- Clean external glass, metal and plastic parts only with non-aggressive detergents. Stop immediately using those products if detecting any visual or tactile characteristic change on surfaces and thoroughly rinse with water (examples: glass becoming mat/scratched/other, or plastic discoloring/melting/other, or metal showing rust/stains/scratches). Carefully dry after rinsing.



### IMPORTANT

As for the plastic handle, do not use detergents containing sodium hypochlorite.

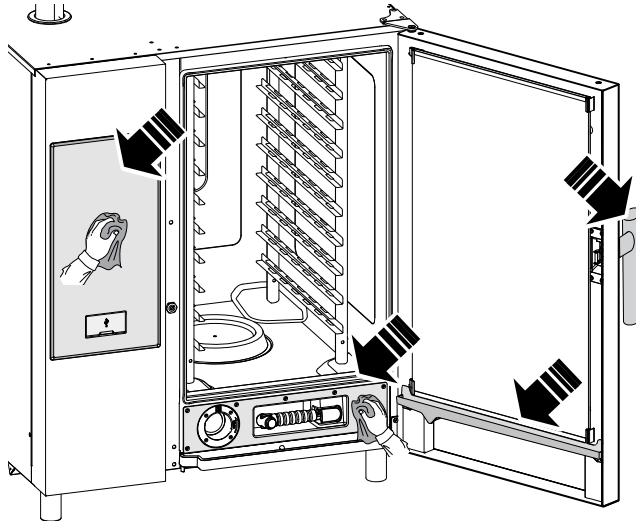

- Clean the stainless steel parts every day using lukewarm neutral soapy water; Rinse with plenty of water and dry thoroughly.
- Do not clean the stainless steel with steel wool, brushes or scrapers in common steel, as they could deposit ferrous particles which oxidize, causing rust spots;

## G.15 Periods of non-use

If the appliance is not going to be used for some time, take the following precautions:

- close the water supply tap(s), if present;

## G.19 Maintenance intervals

It is advisable to carry out the checks with the frequency given in the following table:

Maintenance, inspections, checks and cleaning	Frequency	Responsibility
Ordinary cleaning <ul style="list-style-type: none"> <li>• general cleaning of appliance and surrounding area</li> </ul>	<ul style="list-style-type: none"> <li>• Daily</li> </ul>	<ul style="list-style-type: none"> <li>• Operator</li> </ul>
Mechanical protection devices <ul style="list-style-type: none"> <li>• check their condition and for any deformation, loosening or removed parts</li> </ul>	<ul style="list-style-type: none"> <li>• Every 6 months</li> </ul>	<ul style="list-style-type: none"> <li>• Service</li> </ul>
Control <ul style="list-style-type: none"> <li>• check the mechanical parts, for cracks or deformations, tightening of screws: check the readability and condition of words, stickers and symbols and restore if necessary</li> </ul>	<ul style="list-style-type: none"> <li>• Yearly</li> </ul>	<ul style="list-style-type: none"> <li>• Service</li> </ul>
Appliance structure <ul style="list-style-type: none"> <li>• tightening of main bolts (screws, fixing systems, etc.) of appliance</li> </ul>	<ul style="list-style-type: none"> <li>• Yearly</li> </ul>	<ul style="list-style-type: none"> <li>• Service</li> </ul>
Safety signs <ul style="list-style-type: none"> <li>• check the readability and condition of safety signs</li> </ul>	<ul style="list-style-type: none"> <li>• Yearly</li> </ul>	<ul style="list-style-type: none"> <li>• Service</li> </ul>

- close the gas valves;
- disconnect the power supply or remove the plug from the power socket, if present;
- clean the cabinet, going over all the stainless steel surfaces vigorously with a rag moistened with paraffin oil to create a protective film;
- periodically air the premises.



### IMPORTANT

The warranty does not cover any damages caused by ice formations in the appliance pipes.

## G.16 Boiler maintenance

In case of excessive scale in the boiler the display signals the need to carry out descaling.

- For boiler descaling see F.16.2 *BOILER DESCALING* paragraph.



### IMPORTANT

The manufacturer declines any liability if these prescriptions are not respected; Also, the warranty does not cover the repair or replacement of components damaged by scale whenever the required supply water characteristics are not respected.

## G.17 Replacing wear and tear components

There are parts, whose damage happens because of the ordinary use during a period, which are not covered by the manufacturer warranty.

## G.18 Repair and extraordinary maintenance



### NOTE!

Repair and extraordinary maintenance have to be carried out by specialised authorised personnel, who can ask the manufacturer to supply a servicing manual.

Maintenance, inspections, checks and cleaning	Frequency	Responsibility
Electrical control panel <ul style="list-style-type: none"> <li>check the electrical components installed inside the electrical control panel. Check the wiring between the electrical panel and appliance parts</li> </ul>	<ul style="list-style-type: none"> <li>Yearly</li> </ul>	<ul style="list-style-type: none"> <li>Service</li> </ul>
Electrical connection cable <ul style="list-style-type: none"> <li>check the connection cable (replace if necessary)</li> </ul>	<ul style="list-style-type: none"> <li>Yearly</li> </ul>	<ul style="list-style-type: none"> <li>Service</li> </ul>
General appliance overhaul <ul style="list-style-type: none"> <li>check all components, electrical equipment, corrosion, pipes...</li> </ul>	Every 10 years <sup>1</sup>	<ul style="list-style-type: none"> <li>Service</li> </ul>

1. The appliance is designed and built for a duration of about 10 years. After this period of time (from commissioning) the appliance must undergo a general inspection and overhaul.

## H TROUBLESHOOTING

### H.1 Introduction

Certain faults may occur during normal use of the appliance. In some cases, faults can be eliminated easily and quickly by following the indication below.

The display, if present, always shows a warning message or alarm describing the occurring fault.

	Warnings icon
	Alarms signalling icon

The alarm icon shows up on the display with a message indicating the number, the code, the date and issue in progress.

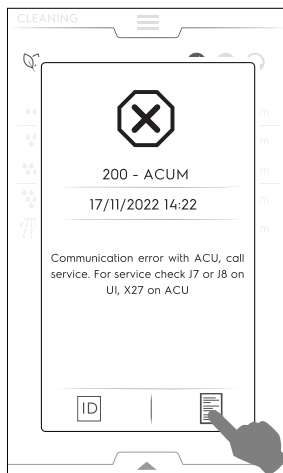

For more info about the alarm, touch icon to open the “Technical Service ID” page or icon to open the “Data Monitor” pages.

#### If the fault persists, contact the Customer Care Service:

1. Disconnect the appliance from the main power supply;
2. Switch off the safety circuit breaker ahead of the appliance;
3. Close the gas and water tap(s), if they are present;
4. Remember to specify:
  - the type of fault
  - the appliance PNC (product number code)
  - the Ser. No. (appliance serial number).



#### IMPORTANT

The appliance PNC and serial number are essential for identifying the type of appliance and date of manufacture.

### H.2 Error codes

Check the anomaly indicated by the warning alarm and, if required, contact the Customer Care Service.

Anomaly	Type of anomaly	Description	Possible causes	Actions
ACF N°323	Warning	Air filter absent	<ul style="list-style-type: none"> <li>Filter not detected;</li> <li>Possible damage to internal electric and electronic components due to air filter absence.</li> </ul>	<ul style="list-style-type: none"> <li>Refit the filter;</li> <li>If the problem persists call Service.</li> </ul>
ACUM N°200	Stops oven	Main electronic board not identified	Communication problem with the main electronic board.	<ul style="list-style-type: none"> <li>Switch the oven OFF/ON;</li> <li>If the error persists, call Service.</li> </ul>



Anomaly	Type of anomaly	Description	Possible causes	Actions
ACUP N°205	Stops oven	Communication protocol error detected	The ACU has not been programmed correctly. The SD Card on the UI may be corrupted and not able to perform the ACU update with the software temporarily loaded on it.	<ul style="list-style-type: none"> <li>Switch the oven OFF/ON;</li> <li>If the error persists, call Service.</li> </ul>
ACSS N°116	Blocks oven; fatal error	ACS software version (inside ACU board) incompatible with present UI SW version	Wrong software upload (example: after replacing ACU board, the SW is not uploaded)	ACS software version (inside ACU board) incompatible with present UI SW version. Call service
ACUS N°115	Blocks oven; fatal error	ACU software version (main uC) incompatible with present UI SW version	Wrong software upload (example: after replacing ACU board, the SW is not uploaded)	ACU software version (main uC) incompatible with present UI SW version. Call Service.
ASCH N°292	Warning	Component compartment temperature warning	<ul style="list-style-type: none"> <li>Filter is dirty;</li> <li>Too high room temperature.</li> </ul>	<ul style="list-style-type: none"> <li>Check room temperature considering the oven needs fresh air to cool electronic compartment.</li> <li>Clean the filter;</li> <li>Allow oven to cool before cooking;</li> <li>If the problem persists, call Service.</li> </ul>
bAtt N°110	Warning	Battery is low	Ageing	Call Service to replace battery.
BEtc N°243	Stops cleaning	Error, excessive time on closing operation during cleaning	Mechanical or electrical problem with vent valve.	Call Service
BEto N°242	Stops cleaning	Error, excessive time on opening operation during cleaning	Mechanical or electrical problem with vent valve.	Call Service
BEtr N°224	Warning	Boiler excessive temperature raising time	The oven has detected a low performance in the boiler.	<ul style="list-style-type: none"> <li>It is possible to cook. Verify the cooking results.</li> <li>If the warning persists call Service.</li> </ul>
Bhtc N°241	Warning	Warning on excessive time on closing operation	<ul style="list-style-type: none"> <li>Flap (venting valve) motoreducer or micro switch failure.</li> <li>Obstruction at the venting valve inlet.</li> </ul>	<p>It is possible to continue using the oven. Cooking results maybe different from usual.</p> <ul style="list-style-type: none"> <li>With the oven OFF and cold, check if any obstruction at the ventilation chimney on the top of the oven: remove the obstruction if any;</li> <li>If the problem persists, call Service.</li> </ul>
Bhto N°240	Warning	Warning on excessive time on opening operation	<ul style="list-style-type: none"> <li>Flap (venting valve) motoreducer or micro switch failure.</li> <li>Obstruction at the venting valve inlet.</li> </ul>	<p>It is possible to continue using the oven. Cooking results maybe different from usual.</p> <ul style="list-style-type: none"> <li>With the oven OFF and cold, check if any obstruction at the ventilation chimney on the top of the oven: remove the obstruction if any;</li> <li>If the problem persists, call Service.</li> </ul>
bntC N°313	Stops boiler	Boiler SSR NTC failure (NTC4)	Temperature sensor issue.	<p>The oven has detected a problem with boiler operation.</p> <ul style="list-style-type: none"> <li>Verify cooking results;</li> <li>If the problem persists, call Service.</li> </ul>
BoLt N°223	Stops cycle (if the cycle needs the boiler)	Boiler water loading timeout	<ul style="list-style-type: none"> <li>Water supply (pressure/ quality of water).</li> <li>Electric insulation problem with water level sensors.</li> </ul>	<ul style="list-style-type: none"> <li>Check if the water supply is open;</li> <li>Check if the water pressure is not too low;</li> <li>Verify if the water filter is clogged. Clean it or replace it;</li> <li>Mechanical problem with boiler operation. If the problem persists call Service.</li> </ul>

Anomaly	Type of anomaly	Description	Possible causes	Actions
BSHt N°315	Warning	Boiler SSR NTC (NTC4) high temperature	<ul style="list-style-type: none"> <li>Inlet air filter dirty;</li> <li>Cooling fan failure;</li> <li>Cooling inlet air sucking warm/hot air;</li> <li>Oven installed by hot machine;</li> <li>Steam/Heat leakage in the electronic compartment;</li> </ul>	<ul style="list-style-type: none"> <li>Do not switch the oven Off;</li> <li>Wait for the temperature to decrease;</li> <li>Clean the inlet air filter;</li> <li>Check with a thin strip of paper whether a consistent air flow can be detected at the cooling air inlet: if not, call Service;</li> <li>Check if the inlet cooling air may be affected by heat produced in the kitchen (in case the oven is located by hot appliances, stop working with those appliances and inform Service);</li> <li>If the error persists, call Service.</li> </ul>
BSOt N°314	Stops cooking cycle	Boiler SSR NTC over-temperature (NTC4)	<ul style="list-style-type: none"> <li>Inlet air filter dirty;</li> <li>Cooling fan failure;</li> <li>Cooling inlet air sucking warm/hot air;</li> <li>Oven installed by hot machine,</li> <li>Steam/Heat leakage in the electronic compartment.</li> </ul>	<p>The oven can continue to work in recovery mode: cooking cycles will not use the boiler.</p> <ul style="list-style-type: none"> <li>Do not switch the oven Off;</li> <li>Wait for the temperature to decrease;</li> <li>Clean the inlet air filter;</li> <li>Check with a thin strip of paper whether a consistent air flow can be detected at the cooling air inlet: if not, call service;</li> <li>Check if the inlet cooling air may be affected by heat produced in the kitchen (in case the oven is located by hot appliances, stop working with those appliances and inform Service);</li> <li>If the error persists, call Service.</li> </ul>
butn N°101	Stops oven	One or a combination of the panel buttons are permanently blocked	The panel has been accidentally hit or damaged.	Press all buttons to possibly unlock the wrong one/ones. The permanent blocked buttons are lighted during the error on display.
Cdo N°260	Stops cleaning Warning in cooking	Cleaning drawer cap absent	<ul style="list-style-type: none"> <li>The cap of the cleaning drawer is not detected; it is not possible to FINISH a cooking or cleaning cycle.</li> </ul>	<p>The oven can continue to cook but cleaning cycle could not be performed until the drawer cap will be in place;</p> <ul style="list-style-type: none"> <li>Screw correctly the cap on the cleaning drawer in the front of the oven;</li> <li>If the error persists, rotate the cap 180° and screw again. Call Service.</li> </ul>
CFbL N°294	Warning	Cooling fan failure	<ul style="list-style-type: none"> <li>Cooling fan motor overload due to dirt or oxidation</li> <li>Other electrical/mechanical issue</li> </ul>	<p>The oven will be operative until the electronic will reach the critical temperature.</p> <p>Call Service</p>
CLdr	Warning	Cleaning drawer cap missing before starting a cooking or cleaning cycle	<ul style="list-style-type: none"> <li>The cap of the cleaning drawer is not detected. It is not possible to START a cooking or cleaning cycle.</li> </ul>	<ul style="list-style-type: none"> <li>Screw correctly the cap on the cleaning drawer in the front of the oven;</li> <li>If the error persists, rotate the cap 180° and screw again. Call Service.</li> </ul>
CntC N°310	Stops cooking	Cavity SSR NTC failure (NTC3)	<ul style="list-style-type: none"> <li>Connector failure;</li> <li>NTC sensor failure;</li> <li>ACU failure;</li> </ul>	<ul style="list-style-type: none"> <li>Restart the oven;</li> <li>If the error persists, call Service.</li> </ul>
CPUA N°203	Stops oven	ACS microprocessor does not communicate	ACU failure.	<ul style="list-style-type: none"> <li>Restart the oven;</li> <li>If the error persists, call Service.</li> </ul>
CPUt N°204	Stops oven	TC microprocessor does not communicate	ACU failure.	<ul style="list-style-type: none"> <li>Restart the oven;</li> <li>If the error persists, call Service.</li> </ul>

Anomaly	Type of anomaly	Description	Possible causes	Actions
CSHt N°312	Warning	Cavity SSR NTC high temperature (NTC3)	<ul style="list-style-type: none"> <li>Inlet air filter dirty;</li> <li>Cooling fan failure,</li> <li>Cooling inlet air sucking warm/hot air;</li> <li>Oven installed by hot machine;</li> <li>Steam/Heat leakage in the electronic compartment;</li> </ul>	<ul style="list-style-type: none"> <li>Do not switch the oven Off;</li> <li>Wait for the temperature to decrease;</li> <li>Clean the inlet air filter;</li> <li>Check with a thin strip of paper whether a consistent air flow can be detected at the cooling air inlet: if not, call Service;</li> <li>Check if the inlet cooling air may be affected by heat produced in the kitchen (in case the oven is located by hot appliances, stop working with those appliances and inform Service);</li> <li>If the error persists, call Service.</li> </ul>
CSOt N°311	Stops cooking cycle	Cavity SSR NTC over-temperature (NTC3)	<ul style="list-style-type: none"> <li>Inlet air filter dirty;</li> <li>Cooling fan failure;</li> <li>Cooling inlet air sucking warm/hot air;</li> <li>Oven installed by hot machine;</li> <li>Steam/Heat leakage in the electronic compartment;</li> </ul>	<p>The oven can continue to work in recovery mode: cooking cycles will not use the boiler.</p> <ul style="list-style-type: none"> <li>Do not switch the oven OFF;</li> <li>Wait for the temperature to decrease;</li> <li>Clean the inlet air filter;</li> <li>Check with a thin strip of paper whether a consistent air flow can be detected at the cooling air inlet: if not, call service;</li> <li>Check if the inlet cooling air may be affected by heat produced in the kitchen (in case the oven is located by hot appliances, stop working with those appliances and inform Service);</li> <li>If the error persists, call Service.</li> </ul>
dESC N°230	Warning	Descalce Boiler	Parameter bSCt has been reached.	Run a cleaning program including the rinse and descale cycle and use 2 tabs C25 only for 6-10 grids models and 3 tabs only for 20 grids models (follow the procedure as per Operating Manual).
EbOL N°222	Stops cycle/preheating	Boiler thermocouple failure	<ul style="list-style-type: none"> <li>Connector failure;</li> <li>TC sensor failure;</li> <li>ACU failure.</li> </ul>	<p>The oven can continue to work without preheating (check the cooking results).</p> <ul style="list-style-type: none"> <li>Inform Service about the failure.</li> </ul>
EbYP N°250	Warning	Steam exhaust temperature sensor failure.	<ul style="list-style-type: none"> <li>Connector failure;</li> <li>TC sensor failure;</li> <li>ACU failure.</li> </ul>	<p>The oven can continue to work, it is possible that water consumption increases.</p> <p>Call Service.</p>
ECEd N°213	Stops cycle	Bottom cavity thermocouple failure	<ul style="list-style-type: none"> <li>Connector failure;</li> <li>TC sensor failure;</li> <li>ACU failure.</li> </ul>	<p>The oven can continue to work only with 100 °C steam cycle.</p> <p>Call Service.</p>
ECEu N°212	Stops cycle	Upper cavity thermocouple failure	<ul style="list-style-type: none"> <li>Connector failure;</li> <li>TC sensor failure;</li> <li>ACU failure.</li> </ul>	<p>The oven can continue to work only with 100 °C steam cycle.</p> <p>Call Service.</p>
ECLt N°135	Stops oven	Cleaning table not present for the MODEL and the DETERGENT TYPE in use	Software missing	<p>Cleaning table not present for the MODEL and the DETERGENT TYPE in use.</p> <p>Call Service.</p>
EGA0 N°130	Stops oven	No one valid GAS table present in the oven	Software missing	<p>No one valid GAS table present in the oven.</p> <p>Call Service.</p>
EGAd N°132	Stops oven	Wrong GAS table data	Software missing	<p>Wrong GAS table data.</p> <p>Call Service.</p>
EGAt N°131	Stops oven	GAS table for this appliance model not found	Software missing	<p>GAS table for this appliance model not found.</p> <p>Call Service.</p>
EH2O N°327	Stops oven	Water measured inconsistent with valves state	<ul style="list-style-type: none"> <li>Water supply valve closed or partly closed;</li> <li>Temporary lack of water supply pressure;</li> <li>Flow meter failure;</li> <li>Water system issue.</li> </ul>	<p>The oven can continue to work (check the cooking results).</p> <ul style="list-style-type: none"> <li>Check if the water supply valve is open;</li> <li>Check the water pressure is &gt; 1,5 bar;</li> <li>If the problem, persists call Service.</li> </ul>

Anomaly	Type of anomaly	Description	Possible causes	Actions
ELMb N°322	Stops cooking with humidity control (in NORMAL mode)	Detected a problem with the oxygen sensor	<ul style="list-style-type: none"> <li>• Lambda probe failure.</li> </ul>	<p>It is possible to change the alerting mode of this failure:</p> <ul style="list-style-type: none"> <li>• NORMAL: the oven stops any cycle requiring humidity control.</li> <li>• ADVANCED: the alarm is a warning. The oven keeps working in "Recovery mode." It is still possible to run the cycles with possible non optimal performances.</li> <li>• HIDDEN: no alarm shown</li> </ul> <p>To modify the alerting mode contact the Service.</p>
EntC N°290	Stops oven	component compartment NTC failure (NTC1)	<ul style="list-style-type: none"> <li>• Connector failure;</li> <li>• TC sensor failure;</li> <li>• ACU failure.</li> </ul>	<p>Electronic board temperature sensor damaged.</p> <ul style="list-style-type: none"> <li>• Cooking impossible.</li> <li>• Call Service.</li> </ul>
Eotd N°251	Warning	High temperature on water drain	Possible lack of water in the drain system.	<ul style="list-style-type: none"> <li>• Check that the oven has water supply;</li> <li>• Pour some fresh water on the bottom cavity filter; pay attention, do not splash hot cavity with cold water as it could damage the machine.</li> <li>• If the problem persists call Service.</li> </ul>
Eprb1 N°320	Stops only food probe cycles	Single point core probe failure	<ul style="list-style-type: none"> <li>• Food probe misuse (for example, wire pulled or squeezed);</li> <li>• Connector failure;</li> <li>• Probe failure;</li> <li>• ACU failure.</li> </ul>	<p>It is possible to run cycles based on time (without food probe);</p> <ul style="list-style-type: none"> <li>• If available, use the accessory USB food probe;</li> <li>• Call service to restore full functionality.</li> </ul>
Epr6 N°321	Stops only food probe cycles	Six points core probe failure	<ul style="list-style-type: none"> <li>• Food probe misuse (for example, wire pulled or squeezed);</li> <li>• Connector failure;</li> <li>• Probe failure;</li> <li>• ACU failure.</li> </ul>	<p>It is possible to run cycles based on time (without food probe);</p> <ul style="list-style-type: none"> <li>• If available, use the accessory USB food probe;</li> <li>• Call service to restore full functionality.</li> </ul>
Ertc N°1	Warning	Problem with internal clock	Issue with hardware (for example battery clock exhausted).	<p>It is possible that some functionality do not work (for example HCCP).</p> <ul style="list-style-type: none"> <li>• Call Service.</li> </ul>
ESCH N°291	Stops oven	Component compartment overtemperature	<ul style="list-style-type: none"> <li>• Filter is dirty;</li> <li>• Too high room temperature.</li> </ul>	<ul style="list-style-type: none"> <li>• Check room temperature considering the oven needs fresh air to cool electronic compartment;</li> <li>• Clean the filter;</li> <li>• Allow oven to cool before cooking;</li> <li>• Call Service if the problem reoccurs.</li> </ul>
EStd N°253	Warning	Water drain NTC failure	<ul style="list-style-type: none"> <li>• Connector failure</li> <li>• NTC sensor failure</li> <li>• ACU failure</li> </ul>	<p>The oven continue to work.</p> <ul style="list-style-type: none"> <li>• Call Service to fix the issue.</li> </ul>
Etb N°220	Stops cycle/boiler	Boiler safety thermostat trips. Overtemperature in the boiler.	<ul style="list-style-type: none"> <li>• Missing water in the boiler;</li> <li>• Limestone accumulation in the boiler;</li> <li>• Wrong insertion of the TC probe sensor;</li> <li>• The safety thermostat bulb or the capillary are damaged;</li> <li>• Leakage of heat in the safety thermostat body area;</li> <li>• The parameter BOT is set too high;</li> <li>• Room temperature &lt;5°C.</li> </ul>	<p>The oven is not able to produce steam with the boiler. An alternative device will be used, but the performance will be reduced;</p> <ul style="list-style-type: none"> <li>• Call service to restore the boiler functionality.</li> </ul>

Anomaly	Type of anomaly	Description	Possible causes	Actions
EtC N°210	Stops the oven	Cavity safety thermostat trips. Overtemperature in the cavity	<ul style="list-style-type: none"> <li>The cavity is dirty;</li> <li>The parameter COT is set too high;</li> <li>The safety thermostat bulb or the capillary are damaged;</li> <li>The motor fan is blocked while the heat is still On;</li> <li>The temperature TC sensor provides erratic measurements</li> <li>Leakage of heat in the safety thermostat body area.</li> <li>Room temperature &lt;5°C.</li> </ul>	Manually clean the oven cavity and call Service.
EtUb N°221	Stops boiler cycles	Boiler overtemperature	<ul style="list-style-type: none"> <li>Missing water in the boiler (electric heated appliances only);</li> <li>Limestone accumulation in the boiler;</li> <li>The parameter BOT is set too low.</li> </ul>	<ul style="list-style-type: none"> <li>Wait for the boiler temperature to cool down (alarm ETUB will disappear)</li> <li>Run a cleaning program including the rinse and descale cycle and use the quantity of C25 tabs indicated in F.16.2 <i>BOILER DESCALING</i> procedure of this Manual);</li> <li>In case the alarm re-appears, descale the boiler again.</li> <li>If the problem persists, call Service.</li> </ul>
EtUC N°211	Stops the oven	Cavity overtemperature	<ul style="list-style-type: none"> <li>The cavity is dirty;</li> <li>The parameter COT is set too low.</li> </ul>	<ul style="list-style-type: none"> <li>Launch a cooling cycle; if not possible open the door and let the oven to cool down; clean the cavity.</li> <li>When the temperature drops it is possible to launch a new cooking cycle.</li> <li>If the error shows up again call Service.</li> </ul>
FA8H N°324	After ending cooking cycle, stops oven cooking	Oven worked 8 hours without air inlet filter	Misuse	Restore the air inlet filter checking its cleanness before fitting it back in place. In case the filter is lost, call Service
FCLn	Stops next cooking cycle	Forced Cleaning	Maximum cooking time elapsed from last automatic cleaning cycle.	Run an automatic cleaning cycle.
FCt	Stops oven		The User Interface is not programmed with the software	Call Service.
FDXX (XX = 00 - 17)	Stops oven	Lower cavity motor failure	Diagnostic according to error number (from 00 to 17) displayed.	Switch the oven OFF/ON; If the error persists, manually clean the oven cavity and call Service.
FLA1 N°102	Stops oven; fatal error	The FLASH EPROM ID is different as expected		Communication impossible with external SPI-FLASH memory. <ul style="list-style-type: none"> <li>Switch OFF and ON the oven, if the problem persists, call Service.</li> </ul>
FLA2 N°103	Stops oven; fatal error	Communication channel between FRAM and microcontroller is malfunctioning or blocked		Unknown SPI-FLASH memory device. <ul style="list-style-type: none"> <li>Switch OFF and ON the oven, if the problem persists, call Service.</li> </ul>
FLEE N°142	Stops oven	SPI-FLASH memory block erase error (4kb block)		Error during SPI-FLASH memory block erase. <ul style="list-style-type: none"> <li>Switch OFF and ON the oven, if the problem persists, call Service.</li> </ul>
FLrE N°140	Stops oven	SPI-FLASH memory reading error		Error during SPI-FLASH memory reading. <ul style="list-style-type: none"> <li>Switch OFF and ON the oven, if the problem persists, call Service.</li> </ul>

<b>Anomaly</b>	<b>Type of anomaly</b>	<b>Description</b>	<b>Possible causes</b>	<b>Actions</b>
FLUE N°141	Stops oven	SPI-FLASH memory writing error		Error during SPI-FLASH memory writing. <ul style="list-style-type: none"> <li>Switch OFF and ON the oven, if the problem persists, call Service.</li> </ul>
FrA1 N°104	Stops oven; fatal error	The FRAM ID is different as expected		Communication impossible with FRAM memory. <ul style="list-style-type: none"> <li>Switch OFF and ON the oven, if the problem persists, call Service.</li> </ul>
FrA2 N°105	Stop oven; fatal error	The FRAM power fail data calculated MD5 is different as the stored one		Unknown FRAM memory device. <ul style="list-style-type: none"> <li>Switch OFF and ON the oven, if the problem persists, call Service.</li> </ul>
FrMC N°106	Stops oven; fatal error	The FRAM power fail data calculated MD5 is different as the stored one		Software error: invalid data on FRAM memory. <ul style="list-style-type: none"> <li>Switch OFF and ON the oven, if the problem persists, call Service.</li> </ul>
FrrE N°145	Stops oven	FRAM memory reading error		Error during FRAM memory reading. <ul style="list-style-type: none"> <li>Switch OFF and ON the oven, if the problem persists, call Service.</li> </ul>
FrUE N°146	Stops oven	FRAM memory writing error		Error during FRAM memory writing. <ul style="list-style-type: none"> <li>Switch OFF and ON the oven, if the problem persists, call Service.</li> </ul>
FSnr N°293	Warning	Cooling fan issue	<ul style="list-style-type: none"> <li>Inlet air filter dirty</li> <li>Cooling fan failure</li> <li>Filter not present</li> </ul>	<ul style="list-style-type: none"> <li>Clean inlet air filter;</li> <li>Check with a thin strip of paper whether a consistent air flow can be detected at the cooling air inlet: if not, call Service.</li> </ul>
FUXX (XX = 00 - 17)	Stops oven	Upper cavity motor failure	Diagnostic according to error number (from 00 to 17) displayed.	Switch the oven OFF/ON; If the error persists, manually clean the oven cavity and call Service.
GbbU N°301	Stops the boiler	Boiler gas burner locked	<ul style="list-style-type: none"> <li>Air in gas supply;</li> <li>Gas supply is closed;</li> <li>Issue with the electric supply of the burner system;</li> <li>Burner system internal failure;</li> </ul>	The oven can continue to work both in convection and ISG mode. To recover full boiler functionality: <ul style="list-style-type: none"> <li>Switch the oven OFF/ON.</li> <li>If the error occurs at the cycle start, call Service.</li> <li>If the error occurs after 5 ignition attempts: <ol style="list-style-type: none"> <li>check the gas supply main valve is open;</li> <li>reset the error and attempt new cycle;</li> <li>if the error persists, switch OFF/ON the oven and attempt new cycle again;</li> <li>if the error persists, call Service</li> </ol> </li> </ul>
GbCd N°302	Cycle paused	Cavity lower burner locked	<ul style="list-style-type: none"> <li>Air in gas supply;</li> <li>Gas supply is closed;</li> <li>Issue with the electric supply of the burner system;</li> <li>Burner system internal failure;</li> </ul>	The oven will not operate until restoring the burner functionality. To recover the functionality: <ul style="list-style-type: none"> <li>Switch the oven OFF/ON.</li> <li>If the error occurs at the cycle start, call Service.</li> <li>If the error occurs after 5 ignition attempts: <ol style="list-style-type: none"> <li>check the gas supply main valve is open</li> <li>reset the error and attempt new cycle</li> <li>if the error persists, switch OFF/ON the oven and attempt new cycle again;</li> <li>if the error persists, call Service</li> </ol> </li> </ul>

Anomaly	Type of anomaly	Description	Possible causes	Actions
GbCU N°300	Cycle paused	Cavity upper burner locked	<ul style="list-style-type: none"> <li>Air in gas supply;</li> <li>Gas supply is closed;</li> <li>Issue with the electric supply of the burner system;</li> <li>Burner system internal failure;</li> </ul>	<p>The oven will not operate until restoring the burner functionality.</p> <p>To recover the functionality:</p> <ul style="list-style-type: none"> <li>Switch the oven OFF/ON.</li> <li>If the error occurs at the cycle start, call Service.</li> <li>If the error occurs after 5 ignition attempts: <ol style="list-style-type: none"> <li>check the gas supply main valve is open</li> <li>reset the error and attempt new cycle</li> <li>if the error persists, switch OFF/ON the oven and attempt new cycle again;</li> <li>if the error persists, call Service</li> </ol> </li> </ul>
GrCo N°325	Stops cleaning cycle	Grease collector valve opened	Misuse	Ensure to close the grease collector drain valve before restarting the cleaning cycle.
H2OC N°329	Warning	H2O check. The oven retry the water check 3 times every 10min. After that, EH2O is shown	<ul style="list-style-type: none"> <li>Water tap is closed</li> <li>Water flow rate less than 1 l/min</li> <li>No signal feedback from flowmeter</li> </ul>	<ul style="list-style-type: none"> <li>check water tap is open</li> <li>check water pressure is good</li> <li>If the problem persists for 30 min and EH2O rises, call Service</li> </ul>
HdXX (XX = 01-26)	Stops oven	Valves/pumps activations	Diagnostic according to error number (from 01 to 26) displayed.	Switch the oven OFF/ON; If the error persists, follow instructions displayed.
HdPP N°265	Stops liquid cleaning	Valves/pumps activations (ACS feedback)		<ul style="list-style-type: none"> <li>Switch OFF and ON the oven, if the error persists, manually clean the oven cavity and call Service.</li> </ul>
HFnl N°280/ 281	Stops humidifier	Humidifier not working	<ul style="list-style-type: none"> <li>Water missing;</li> <li>ISG circuit obstruction.</li> </ul>	<p>The oven has detected a problem with the humidifier (ISG). It could be possible to cook in convection mode only.</p> <p>Verify the water supply valve is fully open and the water filler has no obstructions. Clean it if needed.</p> <p>If the problem persists, call Service.</p>
Htd N°252	Stops oven	Drain temperature above safety limit	Possible lack of water in the drain system.	<ul style="list-style-type: none"> <li>Check that the oven has water supply;</li> <li>Pour some fresh water on the bottom cavity filter; pay attention, do not splash hot cavity with cold water as it could damage the machine.</li> <li>Wait for the alarm to blink off;</li> <li>If the problem persists, call Service.</li> </ul>
InuS N°118	Stops oven	Inverter software version (YODA board) incompatible with present UI SW version	Wrong software upload (example: after replacing ACU board)	Inverter software version (YODA board) incompatible with present UI SW version. Call service
LPIIn N°227	Stops cycle	Boiler level sensor problem	<ul style="list-style-type: none"> <li>Humid lime shortcutting boiler level sensors.</li> <li>Insulation issues with the boiler level sensors</li> </ul>	<p>The oven can continue to operate in convection or in ISG mode.</p> <ul style="list-style-type: none"> <li>There is a problem with the water level in the boiler: run a cleaning program including the rinse and descale cycle and use 2 tabs C25 only. (Follow the procedure as per Operating Manual);</li> <li>If the problem persists, call Service.</li> </ul>
MCbM / Fd13	Stops oven	Lower inverter communication problem	<ul style="list-style-type: none"> <li>Issue with the motor inverter;</li> <li>Connection or electrical issue.</li> </ul>	<p>Communication error with lower cavity motor inverter.</p> <ul style="list-style-type: none"> <li>Try to switch the oven OFF/ON.</li> <li>If the problem persists, call Service.</li> </ul>
MCTM / FU13 N°201	Stops the oven	Upper inverter communication problem	<ul style="list-style-type: none"> <li>Issue with the motor inverter;</li> <li>Connection or electrical issue,</li> </ul>	<p>Communication error with upper cavity motor inverter.</p> <ul style="list-style-type: none"> <li>Try to switch the oven OFF/ON.</li> <li>If the problem persists, call Service.</li> </ul>

<b>Anomaly</b>	<b>Type of anomaly</b>	<b>Description</b>	<b>Possible causes</b>	<b>Actions</b>
nIUS N°E161	Warning Stops only connectivity	NIU SW version is incompatible with UI SW version.	Once the NIU has been installed, it has been recognized an incompatible software version of the NIU	<ul style="list-style-type: none"> <li>• Call service</li> </ul>
nIUH N°E162	Warning Stops only connectivity	NIU unknown	-	-
nIUC N°E163	Warning Stops only connectivity	NIU configuration not valid	-	-
nIUP N°E164	Warning Stops only connectivity	No valid PNC and SN found		
PCE1 N°125	Stops oven	Wrong Parameter configuration: Appliance with boiler but without lambda probe		Wrong Parameter configuration: Appliance with boiler but without lambda probe.
PdEF	Stops oven	Memorized default parameters corrupted	Physical memory failure	Parameters memory corrupted; <ul style="list-style-type: none"> <li>• Try to switch the oven OFF/ON.</li> <li>• If the problem persists, call service.</li> </ul>
PFOr N°123		One or more Factory parameters are out of range	One or more Factory parameter are out of range	<ul style="list-style-type: none"> <li>• Call service</li> </ul>
PUOr N°122		One or more User parameters are out of range	One or more User parameters are out of range	<ul style="list-style-type: none"> <li>• Call service</li> </ul>
PUSr N°120		The User parameters calculated is different to the stored one	Invalid data on User parameters	<ul style="list-style-type: none"> <li>• Call service</li> </ul>
PFAC N°121	Stops oven	Factory parameters map corrupted	Issue with the SW or with the HW.	<ul style="list-style-type: none"> <li>• Try to switch the oven OFF/ON.</li> <li>• If the problem persists, call Service.</li> </ul>
rtc1 N°111	Warning HACCP will not function	The communication between the RTC and the microcontroller is blocked		Communication impossible with internal clock. <ul style="list-style-type: none"> <li>• Call service</li> </ul>
SbbU N°306	Stops boiler gas	Boiler gas fan speed issue	<ul style="list-style-type: none"> <li>• Burner blower motor overload due to dirt or oxidation;</li> <li>• Other electrical/mechanical issue.</li> </ul>	Burner fan does not reach the desired speed. Call Service.
SbCd N°305	Stops cycle	Cavity lower gas burner blower speed issue	<ul style="list-style-type: none"> <li>• Burner blower motor overload due to dirt or oxidation;</li> <li>• Other electrical/mechanical issue.</li> </ul>	Burner fan does not reach desired speed. <ul style="list-style-type: none"> <li>• Call service</li> </ul>
SbCU N°304	Stops cycle/ convection	Cavity upper gas burner blower speed issue	<ul style="list-style-type: none"> <li>• Burner blower motor overload due to dirt or oxidation;</li> <li>• Other electrical/mechanical issue.</li> </ul>	Burner fan does not reach desired speed. Ovens with boiler can cook in 100°C steam mode. To restore full oven functionality call Service.



Anomaly	Type of anomaly	Description	Possible causes	Actions
SCbL N°107	Stops cleaning	Appliance is ON but ON/OFF switch feedback still OFF	<ul style="list-style-type: none"> <li>Wiring-Connection loose</li> </ul>	<p>The appliance is ON but the ON/OFF switch shows still OFF. Cooking still possible. The cleaning is blocked for safety reason.</p> <ul style="list-style-type: none"> <li>Try to switch the oven OFF/ON. If the alarm persists, it is still possible to operate cooking, but it is recommended not to start any cleaning cycle until the service will have resolved the issue.</li> <li>Clean manually the oven and call Service.</li> </ul>
tCMS N°117	Stops oven; fatal error	TC software version (inside ACU board) incompatible with present UI SW version	Wrong software upload (example: after replacing ACU board)	<p>TC software version (inside ACU board) incompatible with present UI SW version.</p> <ul style="list-style-type: none"> <li>Call service</li> </ul>
Hod0 N°600	Hood level 2 Electric oven: Warning Hood level 2 gas oven: stops oven Hood level 3 (Electric only): Warning Hood level 4 (Electric only): stops oven	Level 2, 3, 4: Malfunction on hood motor regulator	<p>Hood's Electrical power supply off</p> <ul style="list-style-type: none"> <li>Hood Fan safety thermostat over temperature</li> <li>Automatic Controller damage</li> <li>Hood/oven interface cable disconnected or damaged</li> </ul>	<p>Restart oven.</p> <p>If the causes persist, error will appear again, Call service.</p>
hod1 N°601	Warning	Level 4 only: Hood's UV lamp compartment open	UV-C lamp's cassette are not in right position	<p>Restart oven.</p> <p>If the causes persist, error will appear again, call service.</p>
Hod2 N°602	Warning	Level 4 only: Hood's UV lamp compartment open	The cover panel of central technical compartment (UV-C) is not in appropriate position or is not properly closed	<p>Restart oven.</p> <p>If the causes persist, error will appear again, call service.</p>
Hod3 N°603	Warning	Level 4 only: Hood's water separator filter missing	The Demister and Water Separator Filter are not in appropriate position	<p>Restart oven.</p> <p>If the causes persist, error will appear again, call service.</p>
hod5 N°605	Warning	Level 4 only: Hood's lamp 1 missing or not working	Hood's UV-C lamp 1 and/or 2 missing or not working	<p>Restart oven.</p> <p>If the causes persist, error will appear again, call service.</p>
hod6 N°606	Warning	Level 4 only: Hood's lamp 2 missing or not working	Hood's lamp 3 and/or lamp 4 missing or not working	<p>Restart oven.</p> <p>If the causes persist, error will appear again, call service.</p>
UPrb N°620	Stops oven	USB Food Probe missing or removed during cooking	The USB food probe is not correctly plugged	<p>Ensure the USB food probe is correctly plugged.</p> <p>Call service.</p>
Urt2 N°112	Stops oven	The RTC stopped flag is active even after the power on recovery procedure		<p>Internal clock permanently locked.</p> <p>Call service.</p>
Urt3 N°113	Stops oven	The RTC internal oscillator is malfunctioning		<p>Clock oscillator failure.</p> <p>Call service.</p>
USdC N°154	Stops oven	Error during creation of a directory on the USB key		<p>Error during creation of a directory on the USB key.</p> <ul style="list-style-type: none"> <li>Try with another USB key.</li> </ul>
USFC N°151	Stops oven	Error during closure of a file on the USB key		<p>Error during closure of a file on the USB key.</p> <ul style="list-style-type: none"> <li>Try with another USB key.</li> </ul>

Anomaly	Type of anomaly	Description	Possible causes	Actions
USFO N°150	Stops oven	Error during creation / opening of a file on the USB key		Error during creation / opening of a file on the USB key. • Try with another USB key.
USFU N°155	Stops oven	Impossible to write on the USB key: USB key full		Impossible to write on the USB key: USB key full. • Try with another USB key.
USrE N°152	Stops oven	Error during reading of a file on the USB key		Error during reading of a file on the USB key. • Try with another USB key.
USUE N°153	Stops oven	Error during writing of a file on the USB key		Error during writing of a file on the USB key. • Try with another USB key.

### H.3 Oven connectivity issues (depending on your SW version)

If the oven cannot establish a remote connection to Internet, its display shows different icons indicating the connection issue. See below the icons meaning:

#### Connection errors

 Oven not connected to connectivity module

 Not connected to LAN Hub (connected to NIU PROE or IoT module but not to hub)



Not connected to Wifi Hub (connected to connectivity module).



Connected to hub via LAN but not to cloud.



Connected to hub via Wifi but not to cloud.

## I FURTHER INFORMATION

### I.1 Ergonomic features

#### I.1.1 Certification

The ergonomic features of your product, that may influence your physical and cognitive interaction with it, have been assessed and certified.

A product with ergonomic features, in fact, shall fulfil specific ergonomic requirements, belonging to three different areas: Polytechnic, Biomedical and Psychosocial (usability and satisfaction).

For each of these areas, specific tests with real users have been performed. The product is therefore compliant with the ergonomic acceptability criteria requested by the standards applied.

#### I.1.2 General recommendations

The oven or the blast chiller that you use is specifically studied and tested in order to minimise any physical problems associated to the interactions with the product.

The loading and unloading of the trays and the interaction with the product may bring to incongruous postures and handling of heavy weights – characteristics of your daily activity that we tried to relieve.

In any case we would like to suggest a few operating procedures to adopt:

- Handle the tray in a balanced way, trying not to arch your back during the loading/unloading.
- If possible, flex your legs and don't bend forward your back during the placement of the trays in the lower shelves and during the achievement of any lower tools or items.
- If possible, try to place the trays in the cavities considering their weights, as suggested by the pictures below.
- If possible, push the tray holder trolley and pull it in order to reduce the distances.
- Keep the viewing distance in order to understand properly the information displayed in the display or to view the object in the cavity, reducing as much as possible the time spent with the eyes up (neck extensions).

**Suggested movement of trays according to their weights**

Try to place the trays into the cavities considering their weights as suggested by the pictures below.

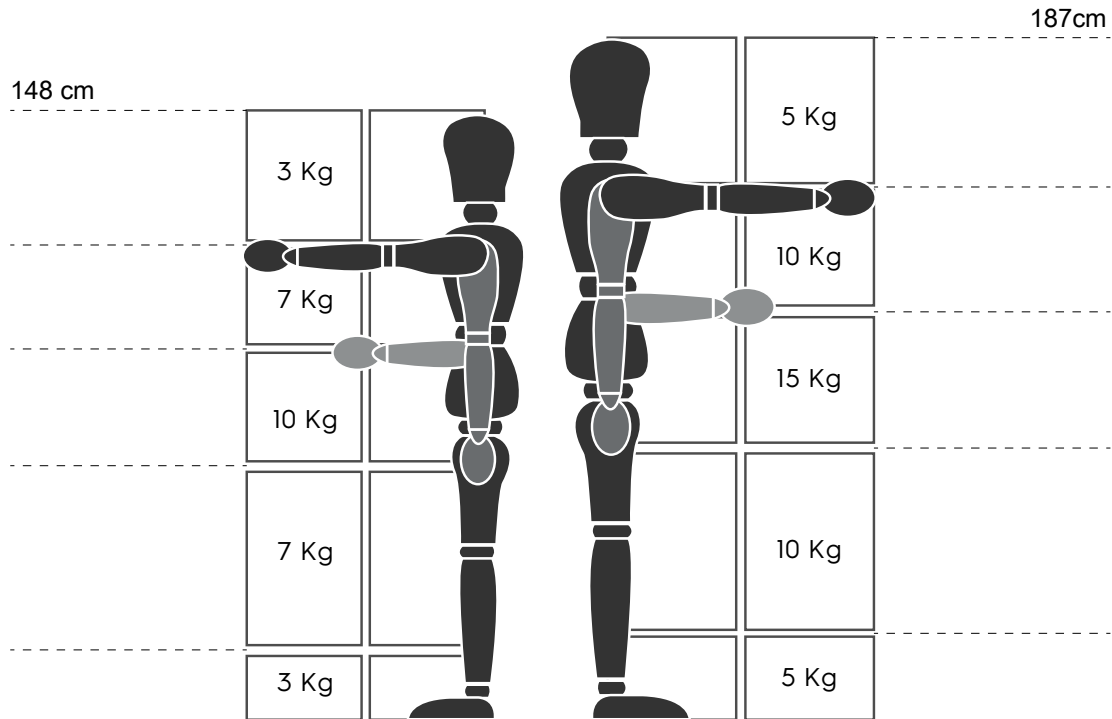

Maximum suggested weighs - "Manual Handling Operations Regulations" - Health and Safety Executive (HSE, UK, 2016)

**Below a few examples of common installations and the maximum suggested weights per trays**

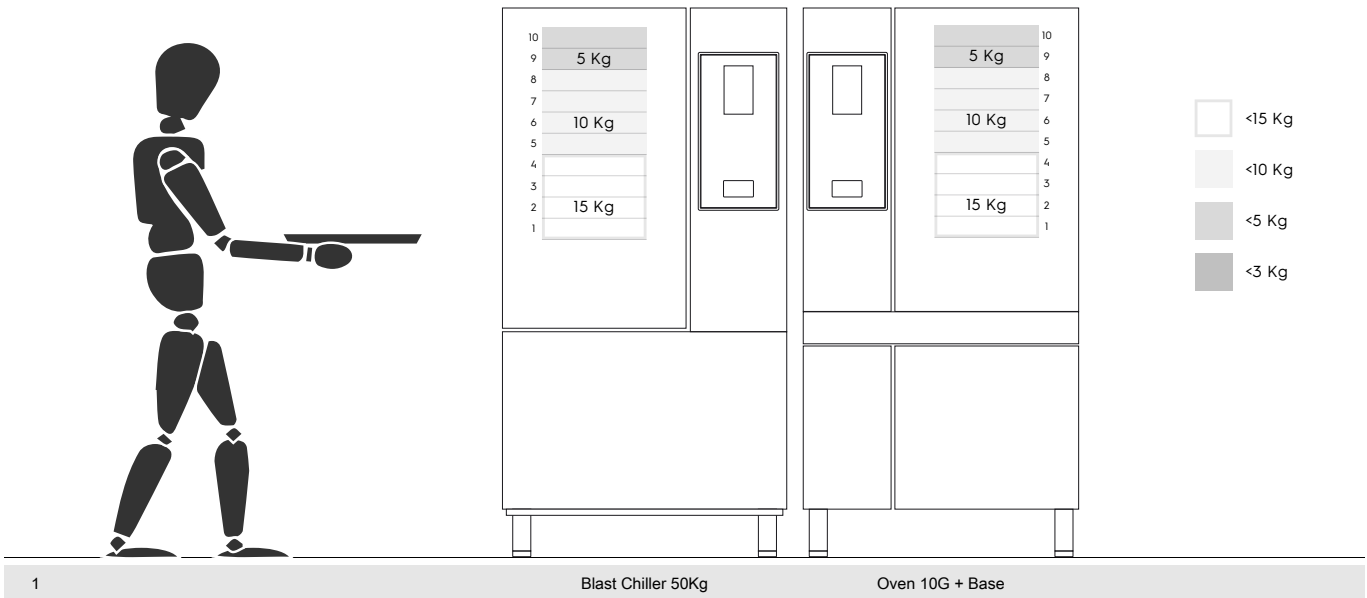

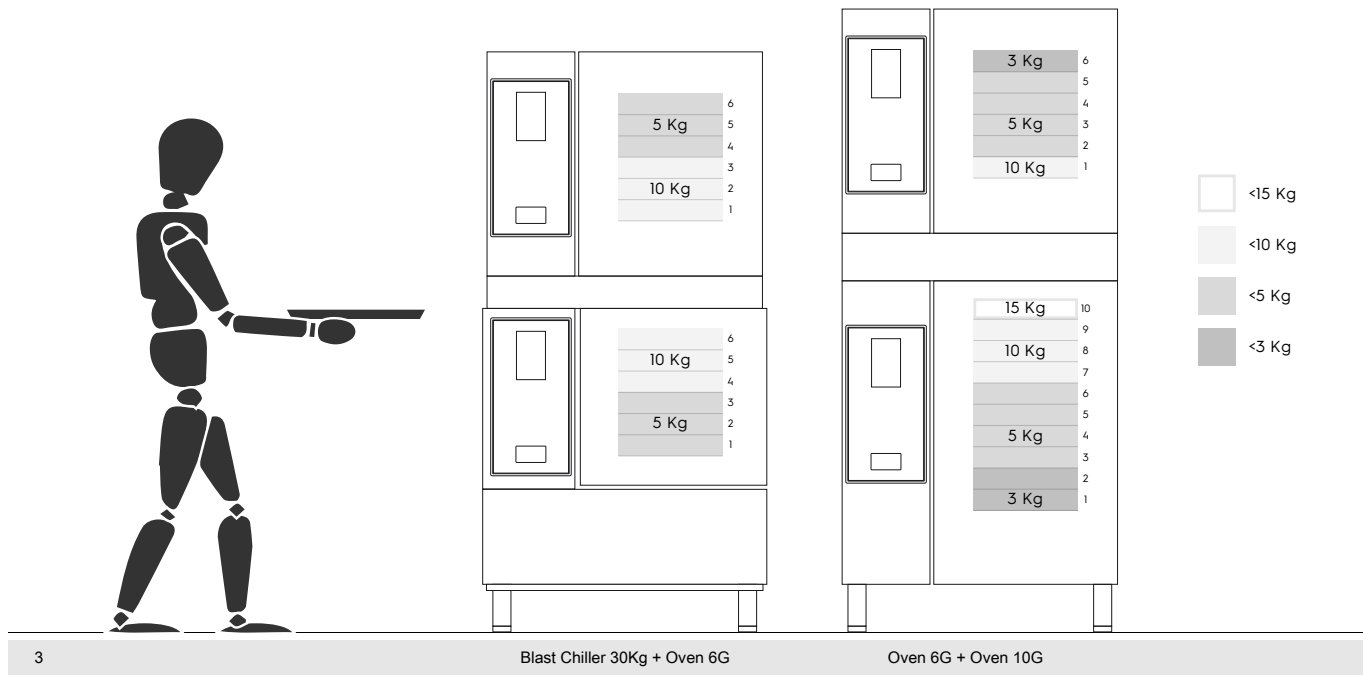

### I.1.2.1 Recommendations on accessories

- For the installation of the 180 Kg Blast Chiller it is suggested the predisposition of the isolated floor to avoid extra strain for the operator who uses the Mobile GastroNorm rack.
- For the wall installation of the 10GN it is suggested the use the Riser accessory not higher than 700 mm to improve easiness of loading.
- In the stacking installation 6GN + 6GN it is suggested to use the adjustable feet accessory 230-290mm (code 922745) and set them at maximum height of 290 mm to facilitate an easy loading.
- In the configuration 6GN + 6GN on Riser accessory it is suggested to load trays with a weight lower than 3 Kg on upper level.



Electrolux Professional SPA  
Viale Treviso 15  
33170 Pordenone  
[www.electroluxprofessional.com](http://www.electroluxprofessional.com)