

Rack type dishwasher

Dual-Rinse



EN User manual *



*Original instructions

59566Q401- 2023.12

Foreword

 Read the following instructions, including the warranty terms before installing and using the appliance.

Visit our website www.electroluxprofessional.com and open the Support section to:

 Register your product

 Get hints & tips of your product, service and repair information

The installation, use and maintenance manual (hereinafter Manual) provides the user with information necessary for correct and safe use of the appliance.

The following must not be considered a long and exacting list of warnings, but rather a set of instructions suitable for improving appliance performance in every respect and, above all, preventing injury to persons and animals and damage to property due to improper operating procedures.

All persons involved in appliance transport, installation, commissioning, use and maintenance, repair and disassembly must consult and carefully read this manual before carrying out the various operations, in order to avoid wrong and improper actions that could compromise the appliance's integrity or endanger people. Make sure to periodically inform the user regarding the safety regulations. It is also important to instruct and update personnel authorised to operate on the appliance, regarding its use and maintenance.

The manual must be available to operators and carefully kept in the place where the appliance is used, so that it is always at hand for consultation in case of doubts or whenever required.

If, after reading this manual, there are still doubts regarding appliance use, do not hesitate to contact the Manufacturer or the authorised Service Centre to receive prompt and precise assistance for better operation and maximum efficiency of the appliance. During all stages of appliance use, always respect the current regulations on safety, work hygiene and environmental protection. It is the user's responsibility to make sure the appliance is started and operated only in optimum conditions of safety for people, animals and property.



IMPORTANT

- The manufacturer declines any liability for operations carried out on the appliance without respecting the instructions given in this manual.
- The manufacturer reserves the right to modify the appliances presented in this publication without notice.
- No part of this manual may be reproduced.
- This manual is available in digital format by:
 - contacting the dealer or reference customer care;
 - downloading the latest and up to date manual on the web site www.electroluxprofessional.com;
- The manual must always be kept in an easily accessed place near the appliance. Appliance operators and maintenance personnel must be able to easily find and consult it at any time.

Contents

A	SAFETY INFORMATION	5
A.1	General information	5
A.2	General safety	5
A.3	Personal protection equipment	6
A.4	Water connection	7
A.5	Electrical connection	7
A.6	Appliance cleaning and maintenance	7
A.7	Machine disposal	7
B	WARRANTY	8
B.1	Warranty terms and exclusions	8
C	GENERAL SAFETY RULES	8
C.1	Introduction	8
C.2	Mechanical safety characteristics, hazards	8
C.3	Protection devices installed on the appliance	8
C.3.1	Guards	8
C.3.2	Safety devices	8
C.4	Emergency switch	8
C.4.1	Emergency switch reinstatement	8
C.5	Safety signs to be placed on the appliance or near its area	9
C.6	Instructions for use and maintenance	9
C.7	Reasonably foreseeable improper use	9
C.8	End of use	9
C.9	Residual risks	9
D	GENERAL INFORMATION	10
D.1	Introduction	10
D.2	Definitions	10
D.3	Machine and manufacturer's identification data	10
D.4	Additional indications	11
D.4.1	How to interpret the factory description	11
D.5	Responsibility	11
D.6	Copyright	11
D.7	Keeping the manual	11
D.8	Recipients of the manual	11
E	NORMAL USE	12
E.1	Correct use	12
E.2	Characteristics of personnel enabled to operate on the appliance	12
E.3	Basic requirements for appliance use	12
F	TECHNICAL DATA	12
F.1	Main technical characteristics	12
G	PRODUCT DESCRIPTION	13
G.1	General description	13
G.2	Machine overview	13
G.3	View of module composition	13
G.4	Description of machine modules	14
G.4.1	Wash zone	14
G.4.2	Rinse zone	14
G.4.3	Prewash zone	14
G.4.4	Drying zone	14
G.4.5	Energy recovery/steam suppression device	14
H	CONTROL PANEL DESCRIPTION	14
H.1	Control panel overview	14
H.2	Touch screen description	14
I	START UP	15
I.1	Positioning and fitting of the tank components	15
I.2	Positioning and fitting of the washing and rinse arms	15
I.3	Starting	16
I.4	Fitting curtains	18
J	OPERATION	19
J.1	Loading dishes on racks	19
J.2	Daily activation	20
J.3	Info menu	21
J.4	Wait rack	21
J.5	End limit switch activated	21
J.6	Door open	21
J.7	Emergency switch	22
J.8	Clean tank filter	22
J.9	Drain tanks	22
J.10	Automatic drain and refill	22
J.11	Shutdown function	22

K	DAILY CLEANING.....	23
K.1	Appliance cleaning.....	23
K.2	Internal cleaning.....	23
K.3	Manual drain	24
L	MAINTENANCE	25
L.1	Maintenance intervals.....	25
L.1.1	Preventive Maintenance	25
L.2	Maintenance frequency.....	25
L.3	Periods of non-use.....	26
L.4	Machine disposal.....	26
L.5	Delime cycle (not available in all models).....	26
M	TROUBLESHOOTING	27
M.1	Common faults.....	27
M.2	General troubleshooting.....	27
N	ALARMS AND WARNINGS.....	29
N.1	Introduction	29
N.2	Alarms	29
N.3	Warning.....	30

A SAFETY INFORMATION

A.1 General information

This appliance is intended to be used for commercial applications, for example in kitchens of restaurants, canteens, hospitals. It must be used for washing or drying (depending on the model) plates, dishes, glassware, cutlery and similar articles.

To ensure safe use of the appliance and a proper understanding of the manual it is necessary to be familiar with the terms and typographical conventions used in the documentation. The following symbols are used in the manual to indicate and identify the various types of hazards:



WARNING

Danger for the health and safety of operators.



WARNING

Danger of electrocution - dangerous voltage.



CAUTION

Risk of damage to the appliance or the product.



IMPORTANT

Important instructions or information on the product



Equipotentiality



Read the instructions before using the appliance



Clarifications and explanations

A.2 General safety

- The appliance must not be used by people (including children) with limited physical, sensory or mental abilities or without experience and knowledge of it, unless instructed in its use and supervised by those responsible for their safety.
 - Do not let children play with the appliance.
 - Keep all packaging and detergents away from children.
 - Cleaning and user maintenance shall not be made by children without supervision.
- The appliances are provided with electric and/or mechanical safety devices for protecting workers and the appliance itself.
- Never operate the appliance, removing, modifying or tampering with the guards, protection or safety devices.
- Do not remove, tamper with or make illegible the appliance marking and safety, danger and instruction signs and labels on the appliance.
- Do not make any modifications to the parts supplied with the appliance.
- Several illustrations in the manual show the appliance, or parts of it, without guards or with guards removed. This is purely for explanatory purposes. Do not use the appliance without the guards or with the protection devices deactivated.
- Unauthorised personnel must not enter the work area.

- Remove any flammable products or items from the work area.
- The following operations have to be carried out by specialised authorised personnel or Customer Care Service provided with all the appropriate personal protection equipment (A.3 *Personal protection equipment*), tools, utensils and ancillary means, who can ask the manufacturer to supply a servicing manual:
 - Installation and assembly;
 - Positioning;
 - Electrical connection;
 - appliance cleaning, repair and extraordinary maintenance;
 - appliance disposal;
 - Work on electrical equipment;

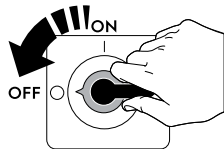
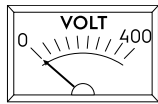





Disconnect the appliance from the power supply before carrying out the below procedures:

- installation, assembly, cleaning and maintenance.

- The operations described must be carried out in compliance with the current safety regulations and provisions in force in the country of use.

A.3 Personal protection equipment

Summary table of the Personal Protection Equipment (PPE) to be used during the various stages of the appliance's service life.

Stage	Protective garments 	Safety footwear 	Gloves 	Glasses 	Safety helmet 
Transport	—	●	○	—	○
Handling	●	●	○	—	—
Unpacking	○	●	○	—	—
Installation	○	●	● ¹	—	—
Normal use	●	●	● ²	○	—
Adjustments	○	●	—	—	—
Routine cleaning	○	●	● ¹⁻³	○	—
Extraordinary cleaning	○	●	● ¹⁻³	○	—
Maintenance	○	●	○	—	—
Dismantling	○	●	○	○	—
Scrapping	○	●	○	○	—
Key:					
●	PPE REQUIRED				

Stage	Protective garments 	Safety footwear 	Gloves 	Glasses 	Safety helmet 
○	PPE AVAILABLE OR TO BE USED IF NECESSARY				
—	PPE NOT REQUIRED				

1. During these operations, gloves must be cut-resistant. Failure to use the personal protection equipment by operators, specialized personnel or users can involve exposure to damage to health (depending on the model).
2. During these operations, gloves must be heatproof and suitable for contact with water and the substances used (refer to the safety data sheet of the substances used for the information regarding the required PPE). Failure to use the personal protection equipment by operators, specialised personnel or users can involve exposure to chemical risk and cause possible damage to health (depending on the model).
3. During these operations, gloves must be suitable for contact with chemical substances used (refer to the safety data sheet of the substances used for information regarding the required PPE). Failure to use the personal protection equipment by operators, specialized personnel or users can involve exposure to chemical risk and cause possible damage to health (depending on the model).

A.4 Water connection

- The operating water pressure (minimum and maximum) must be between:
 - 1.5 bar [150 kPa] and 6 bar [600 kPa].
 - 2 bar [200 kPa] and 6 bar [600 kPa] for models with prewash module installed.
- Make sure that there are no visible water leaks during and after the first use of the machine.

A.5 Electrical connection

- If the power cable is damaged it must be replaced by the Customer Care Service or in any case by specialised personnel, in order to prevent any risk.

A.6 Appliance cleaning and maintenance

- Depending on the model and type of electric connection, during maintenance operations, the cable and plug must be kept in a visible position by the operator carrying out the work.
- Do not touch the appliance with wet hands or feet or when barefoot.
- Do not remove the safety guards.
- Use a ladder with suitable protection for work on appliances with high accessibility.
- Respect the requirements for the various routine and extraordinary maintenance operations. Non compliance with the instructions can create risks for personnel.

Ordinary maintenance

- Do not clean the appliance with a water jet, a high pressure cleaner or a steam cleaner.

A.7 Machine disposal

- Work on the electrical equipment must only be carried out by a specialised personnel, with the power supply disconnected.
- Dismantling operations must be carried out by specialised personnel.
- Make the appliance unusable by removing the power cable and any compartment closing devices, to prevent the possibility of someone becoming trapped inside.
- Refer to “A.3 *Personal protection equipment*” for suitable personal protection equipment.
- When scrapping the machine, the “CE” marking, this manual and other documents concerning the appliance must be destroyed.



IMPORTANT

Save these instructions carefully for further consultation by the various operators.

B WARRANTY

B.1 Warranty terms and exclusions

If the purchase of this product includes warranty coverage, warranty is provided in line with local regulations and subject to the product being installed and used for the purposes as designed, and as described within the appropriate equipment documentation.

Warranty will be applicable where the customer has used only genuine spare parts and has performed maintenance in accordance with Electrolux Professional user and maintenance documentation made available in paper or electronic format.

Electrolux Professional strongly recommends using Electrolux Professional approved cleaning, rinse and descaling agents to obtain optimal results and maintain product efficiency over time.

The Electrolux Professional warranty does not cover:

- service trips cost to deliver and pick up the product;
- installation;
- training on how to use/operate;
- replacement (and/or supply) of wear and tear parts unless resulting from defects in materials or workmanship reported within one (1) week from the failure;
- correction of external wiring;
- correction of unauthorized repairs as well as any damages, failures and inefficiencies caused by and/or resulting from:
 - insufficient and/or abnormal capacity of the electrical systems (current/voltage/frequency, including spikes and/or outages);
 - inadequate or interrupted water supply, steam, air, gas (including impurities and/or other that does not comply with the technical requirements for each appliance);
 - plumbing parts, components or consumable cleaning products that are not approved by the manufacturer;

- customer's negligence, misuse, abuse and/or non-compliance with the use and care instructions detailed within the appropriate equipment documentation;
- improper or poor: installation, repair, maintenance (including tampering, modifications and repairs carried out by third parties not authorized) and modification of safety systems;
- Use of non-original components (e. g.: consumables, wear and tear, or spare parts);
- environment conditions provoking thermal (e. g. overheating/freezing) or chemical (e. g. corrosion/oxidation) stress;
- foreign objects placed in- or connected to- the product;
- accidents or force majeure;
- transportation and handling, including scratches, dents, chips, and/or other damage to the finish of the product, unless such damage results from defects in materials or workmanship and is reported within one (1) week of delivery unless otherwise agreed;
- product with original serial numbers that have been removed, altered or cannot be readily determined;
- replacement of light bulbs, filters or any consumable parts;
- any accessories and software not approved or specified by Electrolux Professional.

Electrolux Professional warranty will be void and manufacturer shall have no liability related thereto in case of any modification of the product or related hardware/software/programming.

Warranty does not include scheduled maintenance activities (including the parts required for it) or the supply of cleaning agents unless specifically covered within any local agreement, subject to local terms and conditions.

Check on Electrolux Professional website the list of authorized customer care.

C GENERAL SAFETY RULES

C.1 Introduction

The machines are provided with electric and/or mechanical safety devices for protecting workers and the machine itself.

Therefore the user must not remove or tamper with such devices. The Manufacturer declines any liability for damage due to tampering or their non-use.

C.2 Mechanical safety characteristics, hazards

The machine does not have sharp edges or protruding parts. The guards for the moving and live parts are fixed to the cabinet with screws, to prevent accidental access.

C.3 Protection devices installed on the appliance

C.3.1 Guards

The guards on the appliance are:

- fixed guards (e.g. casings, covers, side panels, etc.), fixed to the appliance and/or frame with screws or quick-release connectors that can only be removed or opened with tools;
- interlocked movable guards (door) for access inside the appliance;
- appliance electrical equipment access doors, made from hinged panels openable with tools. The door must not be

opened when the appliance is connected to the power supply.

C.3.2 Safety devices

The appliance has:

- interlocks on the front panels giving access to inside the appliance;

C.4 Emergency switch

The emergency switches installed do not exempt operators from diligent and careful use of the machine.

The function of these devices guarantees prompt intervention in case of emergency.

- Operators must know the position of the emergency switches installed on the machine.
- The paths to reach and operate them must be kept free of obstacles.
- Anyone detecting a danger for persons must immediately operate one of the emergency stops. The same applies in case of operation anomalies and/or damage to parts of the machine requiring it to be stopped immediately.

C.4.1 Emergency switch reinstatement

When an emergency switch is operated, restart the machine only after making sure that:

- the cause requiring operation of the emergency switch has been eliminated;
- restarting machine operation does not involve any hazard.

If the EMERGENCY SWITCH is operated during the use of the machine, the entire machine is deactivated.

To reinstate machine operation, proceed as follows:

- release the previously operated red emergency button, turning or pulling it in order to disconnect its interlock;
- restart the machine according to what is described in paragraph "J.2 Daily activation".

C.5 Safety signs to be placed on the appliance or near its area

Prohibition	Meaning
	do not oil, lubricate, repair and adjust moving parts
	do not remove the safety devices
	do not use water to extinguish fires (placed on electrical parts)
Danger	Meaning
	danger of crushing hands
	caution, hot surface
	danger of electrocution (shown on electrical parts with indication of voltage)

C.6 Instructions for use and maintenance

Risks mainly of a mechanical, thermal and electrical nature exist in the appliance. Where possible the risks have been neutralised:

- directly, by means of adequate design solutions.
- indirectly by using guards, protection and safety devices.

Any anomalous situations are signalled on the control panel display.

During maintenance several risks remain, as these could not be eliminated, and must be neutralised by adopting specific measures and precautions.

Do not carry out any checking, cleaning, repair or maintenance operations on moving parts. Workers must be informed of this prohibition by means of clearly visible signs.

To guarantee appliance efficiency and correct operation, periodical maintenance must be carried out according to the instructions given in this manual.

Make sure to periodically check correct operation of all the safety devices and the insulation of electrical cables, which must be replaced if damaged.

C.7 Reasonably foreseeable improper use

Improper use is any use different from that specified in this manual. During appliance operation, other types of work or activities deemed improper and that in general can involve

risks for the safety of operators and damage to the appliance are not allowed. Reasonably foreseeable improper use includes:

- lack of appliance maintenance, cleaning and periodical checks;
- structural changes or modifications to the operating logic;
- tampering with the guards or safety devices;
- failure to use personal protection equipment by operators, specialised personnel and maintenance personnel;
- failure to use suitable accessories (e.g. use of unsuitable equipment or ladders);
- keeping combustible or flammable materials, or in any case materials not compatible with or pertinent to the work, near the appliance;
- wrong appliance installation;
- placing in the appliance any objects or things not compatible with its use, or that can damage the appliance, cause injury or pollute the environment;
- climbing on the appliance;
- non-compliance with the requirements for correct appliance use;
- other actions that give rise to risks not eliminable by the Manufacturer.

C.8 End of use

When the appliance is no longer to be used, make it unusable by removing the mains power supply wiring.

C.9 Residual risks

The appliance has several risks that were not completely eliminated from a design standpoint or with the installation of adequate protection devices. Nevertheless, through this manual the Manufacturer has taken steps to inform operators of such risks, carefully indicating the personal protection equipment to be used by them. In order to reduce the risks, provide for sufficient spaces while installing the unit. To preserve these conditions, the areas around the appliance must always be:

- kept free of obstacles (e.g. ladders, tools, containers, boxes, etc.);
- clean and dry;
- well lit.

For the Customer's complete information, the residual risks remaining on the appliance are indicated below: such situations are deemed improper and therefore strictly forbidden.

Residual risk	Description of hazardous situation
Slipping or falling	The operator can slip due to water or dirt on the floor
Burns/abrasions (e.g. heating elements, cold pan, cooling circuit plates and pipes)	The operator deliberately or unintentionally touches some components inside the appliance without using protective gloves.
Stab wounds	The operator deliberately or unintentionally touches some components with sharp edges during the appliance cleaning without using protective gloves.
Burns	The operator deliberately or unintentionally touches some components inside the appliance or dishes at the outfeed without using gloves or without allowing them to cool.
Shearing of upper limbs	The operator violently closes the front panels.
Electrocution	Contact with live parts during maintenance operations carried out with the electrical panel powered

Residual risk	Description of hazardous situation
Falling from above	The operator intervenes on the appliance using unsuitable systems to access the upper part (e.g. rung ladders, or climbs on it)
Crushing or injury	The specialised personnel may not correctly fix the control panel when accessing the technical compartment. The panel could close suddenly.

Residual risk	Description of hazardous situation
Tipping of loads	When handling the appliance or the packing containing it, using unsuitable lifting systems or accessories or with the unbalanced load
Chemical	Contact with chemical substances (e.g. detergent, rinse aid, scale remover, etc.) without taking adequate safety precautions. Therefore always refer to the safety cards and labels on the products used.



IMPORTANT

In case of a significant anomaly (e.g. short circuits, wires coming out of the terminal block, motor breakdowns, worn electrical cable sheathing, etc.) the operator must immediately deactivate the appliance.

D GENERAL INFORMATION

D.1 Introduction

This manual contains information relevant to various appliances. The product images in this guide are only an example.

The drawings and diagrams given in the manual are not in scale. They supplement the written information with an outline, but are not intended to be a detailed representation of the appliance supplied.

The numerical values given on the appliance installation diagrams refer to measurements in millimeters and/or inches.

D.2 Definitions

Listed below are the definitions of the main terms used in the manual. It is advisable to read them carefully before use.

Operator	machine installation, adjustment, use, maintenance, cleaning, repair and transport personnel.
Manufacturer	Electrolux Professional SpA or any other service centre authorised by Electrolux Professional SpA.
Operator for normal machine use	an operator who has been informed and trained regarding the tasks and hazards involved in normal machine use.
Customer Care service or specialised technician	an operator instructed/trained by the Manufacturer and who, based on his professional and specific training, experience and knowledge of the accident-prevention regulations, is able to appraise the operations to be carried out on the machine and recognise and prevent any risks. His professionalism covers the mechanical, electrotechnical and electronics fields.
Danger	source of possible injury or harm to health.
Hazardous situation	any situation where an operator is exposed to one or more hazards.
Risk	a combination of probabilities and risks of injury or harm to health in a hazardous situation.
Protection devices	safety measures consisting of the use of specific technical means (guards and safety devices) for protecting operators against risks.
Guard	an element of a machine used in a specific way to provide protection by means of a physical barrier.
Safety device	a device (other than a guard) that eliminates or reduces the risk; it can be used alone or in combination with a guard.

Customer	the person who purchased the machine and/or who manages and uses it (e.g. company, entrepreneur, firm).
Emergency stop device	a group of components intended for the emergency stop function; the device is activated with a single action and prevents or reduces damage to persons/machines/property/animals.
Electrocution	an accidental discharge of electric current on a human body.

D.3 Machine and manufacturer's identification data

An example of the marking or data plate on the machine is given below:

Made in EU		2017
F.Mod. _____	Comm.Model _____	
PNC _____	Ser.Nr. _____	
EL _____ V	_____ Hz	_____ kW
Type ref. _____		
CE	IPX5	
Electrolux Professional spa - Viale Treviso, 15 - 33170 Pordenone (Italy)		

The data plate gives the product identification and technical data. The meaning of the various information given on it is listed below:

F.Mod.	factory description of product
Comm.Model	commercial description
PNC	production number code
Ser.Nr.	serial number
V	power supply voltage
Hz	power supply frequency
kW	max. power input
Type ref.	list of acronyms used to identify the type of machine, uniquely
CE	CE marking
IPX5	dust and water protection rating
Electrolux Professional SpA Viale Treviso 15 33170 Pordenone Italy	manufacturer

The data plate is located on the front panel of the equipment.

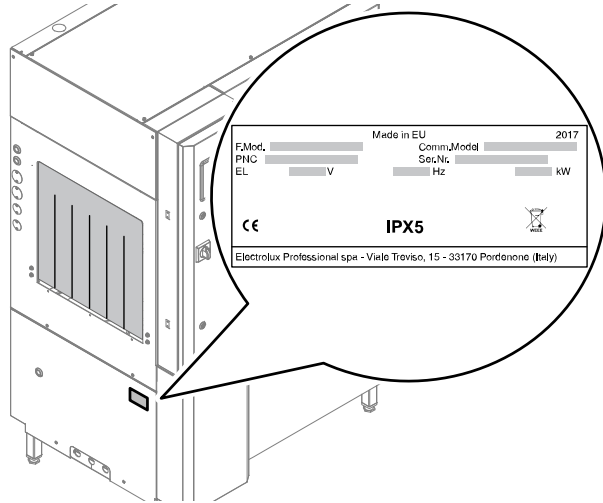

Fig. 1 Data plate position



IMPORTANT

When installing the machine, make sure the electrical connection is carried out in compliance with that specified on the data plate.



NOTE!

Refer to the data given on the machine's data plate for relations with the Manufacturer (e.g. when ordering spare parts, etc.).

D.4 Additional indications

The drawings and diagrams given in the manual are not in scale. They supplement the written information with an outline, but are not intended to be a detailed representation of the machine supplied

The numerical values given on the machine installation diagrams refer to measurements in millimeters and/or inches.

Conventionally, the machine are depicted with the rack feed side on the right ("R"); machine with left rack feed ("L") are depicted only if necessary, in which case the side will be expressly specified.

Due to its size, the machine is sometimes shown schematically divided into its functional modules in order to provide a complete view.

D.4.1 How to interpret the factory description

The factory description on the data plate has the following meaning:

(1)	(2)	(3)	(4)	(5)	(6)	(7)	(8)	(9)
E	DR	150	E	C		5		
Z	DR	20P	E	L		5		V

	Description	Possible variables
(1)	Brand	E=Electrolux Professional, Z= Zanussi, V=Veetsan*
(2)	Machine Type	DR = dual rinse
(3)	Racks/hour	150 = 150 r/h 200 = 200 r/h 20P = 200 r/h with prewash 22" 250 = 250 r/h 25P = 250 r/h with prewash 35"
(4)	Supply	E = electric S = steam
(5)	Direction	R = from right to left L = from left to right C = custom direction on site

	Description	Possible variables
(6)	Hydraulic circuit	Blank = pressure A = atmospheric
(7)	Frequency/ Voltage	5 = 50 Hz — 380-415V 3N~ 6 = 60 Hz — 380-415V 3N~ 4 = 60 Hz — 220-240V 3~ 8 = 60 Hz — 400-440V 3~ Marine version: 5M = 50 Hz — 400V 3~ 6M = 60 Hz — 440V 3~ 5M = 60 Hz — 480V 3~
(8)	Other functions	W = WRAS - Watermark certificate
(9)	Functional level	Blank = no ventless ESD (Energy Saving Device) V = ventless ESD (Energy Saving Device)

D.5 Responsibility

The Manufacturer declines any liability for damage and malfunctioning caused by:

- non-compliance with the instructions contained in this manual;
- repairs not carried out in a workmanlike fashion, and replacements with parts different from those specified in the spare parts catalogue (the fitting and use of non-original spare parts and accessories can negatively affect appliance operation and invalidates the original manufacturer warranty);
- operations carried out by non-specialised personnel;
- unauthorized modifications or operations;
- missing, lack or inadequate maintenance;
- improper appliance use;
- unforeseeable extraordinary events;
- use of the appliance by uninformed and / or untrained personnel;
- non-application of the current provisions in the country of use, concerning safety, hygiene and health in the workplace.

The Manufacturer declines any liability for damage caused by arbitrary modifications and conversions carried out by the user or the Customer.

The employer, workplace manager or service technician are responsible for identifying and choosing adequate and suitable personal protection equipment to be worn by operators, in compliance with regulations in force in the country of use.

The Manufacturer declines any liability for inaccuracies contained in the manual, if due to printing or translation errors.

Any supplements to the installation, use and maintenance manual the Customer receives from the Manufacturer will form an integral part of the manual and therefore must be kept together with it.

D.6 Copyright

This manual is intended solely for consultation by the operator and can only be given to third parties with the permission of Electrolux Professional SpA company.

D.7 Keeping the manual

The manual must be carefully kept for the entire life of the appliance, until scrapping. The manual must stay with the appliance in case of transfer, sale, hire, granting of use or leasing.

D.8 Recipients of the manual

This manual is intended for:

- the employer of machine users and the workplace manager
- operators for normal machine use

- specialised technicians - Customer Care service (see service manual).

E NORMAL USE

E.1 Correct use

Our machines are designed and optimized in order to obtain high performance and efficiency.

This equipment must only be used for its expressly designed purpose, i. e. washing dishes with water and specific detergents. Any other use is to be deemed improper.

E.2 Characteristics of personnel enabled to operate on the appliance

The Customer must make sure the personnel for normal appliance use are adequately trained and skilled in their duties. The operator must:

- read and understand the manual;
- receive adequate training and instruction for their duties in order to operate safely;
- receive specific training for correct appliance use.



IMPORTANT

The Customer must make sure his personnel have understood the instructions received and in particular those regarding work hygiene and safety in use of the appliance.

E.3 Basic requirements for appliance use

- Knowledge of the technology and specific experience in operating the appliance.
- Adequate general basic education and technical knowledge for reading and understanding the contents of the manual, including correct interpretation of the drawings, signs and pictograms.
- Sufficient technical knowledge for safely performing his duties as specified in the manual.
- Knowledge of the regulations on work hygiene and safety.

F TECHNICAL DATA

F.1 Main technical characteristics

Common

Power supply voltage	V	380-415V 3N~ 220-240V 3~ 400-440V 3~
Frequency	Hz	50 Hz 60 Hz
Supply water pressure	bar [kPa]	1.5 bar [150 kPa]...6 bar [600 kPa] 2 bar [200 kPa]...6 bar [600 kPa] ¹
Hot water supply temp.	°C	50 50-65 ²
Cold water supply temp.	°C	15 ³
Concentration of chlorides in water	ppm	<20
Supply water hardness	°f/°d/°e	14/8/10
Electric conductivity of water	µS/cm	<400
Protection rating		IPX5
Nr. wash speeds		3

1. For model with prewash module installed.

2. Hot water temperature recommended for high power models.

3. Cold water temperature recommended for models with ESD.

Machine

Model		150 racks/hour	200 racks/hour	250 racks/hour
Capacity wash at speed 3	racks/h	150	200	250
Water consumption	l/h	180	180	250
	l/basket	1.2	0.9	0.95
Legal noise level Leq	dB(A)	Without ESD	LpA:58dB - KpA:1.5dB ¹	LpA:58dB - KpA:1.5dB ¹
		With ESD	LpA:62dB - KpA:1.5dB ¹	LpA:62dB - KpA:1.5dB ¹

1. The noise emission values have been obtained according to EN ISO 11204.

Prewash

Model		Prewash medium 22"	Prewash large 35"
Tank capacity	l	35	70
Temperature (min - max)	°C	10 - 40	10 - 40

Wash

Tank capacity	l	70
Temperature	°C	55 - 65 [75 - 80] ¹

1. High power models.

Rinse

Model		150 racks/hour	200 racks/hour	250 racks/hour
Temperature	°C	85 [87 - 92] ¹	85 [87 - 92] ¹	85 [87 - 92] ¹
Boiler capacity	l	14	14	14

1. High power models.

G PRODUCT DESCRIPTION

G.1 General description

The rack-type dishwasher is suitable for washing dishes, glasses, cups, cutlery, trays, containers and receptacles in plastic and/or steel used for preparing, cooking and serving; as well as various cooking utensils in ceramic and/or metal. This machine is designed for the above-mentioned applications. Under no circumstances may the machine be used for other applications or ways not provided for in this manual. This machine has been produced to meet the needs for a better work environment and economical efficiency.

The rack-type dishwasher is used in restaurants, cafeterias, cooking centres and large institutions. The special dish racks, that can be equipped with various inserts, offer practical and easy use for obtaining excellent washing results. Rack handling inside the machine occurs automatically. The electronic system enables complete supervision of the washing process. The control panel also has a touch screen that shows the operating parameters and displays any anomalies. In this type of machine the rack is taken from the loading point to the unloading point, through the various washing functions.

Systems for scraping and wetting the dishes (e.g. manual prewash spray) and areas for sorting and arranging them in the racks must be arranged ahead of the dishwasher.

The "Thermal Label" compliant model is designed to guarantee thermal sanitization with a temperature of 71°C [160°F] reached at tableware surface when operating continuously, loaded at 70% of nominal productivity (i.e. racks slightly spaced). Since the performance depends on the load and environmental and water feed condition, before starting washing operations it is suggested to test (using 71°C [160°F] thermal labels) a full-load rack to confirm the effectiveness of parameters; in case of test failure, a lower speed washing cycle must be set and the test repeated.

G.2 Machine overview

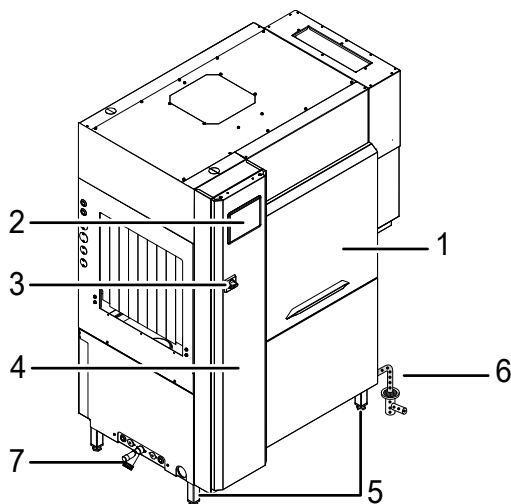

1	Door
2	Control panel

3	Depending on the model: - switch disconnecter or emergency switch
4	Electric box door
5	Feet
6	Water outfeed for draining
7	Water inlet

G.3 View of module composition

Module list

A	Dishwasher (Wash + Rinse)
B	Prewash 22"
C	Prewash 35"

44"

- Depending on the model 150 or 200 racks/hour

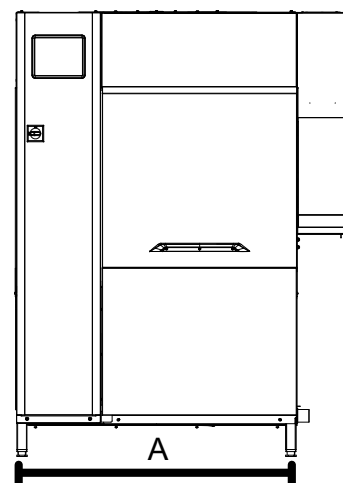

66"

- Depending on the model 200 or 250 racks/hour

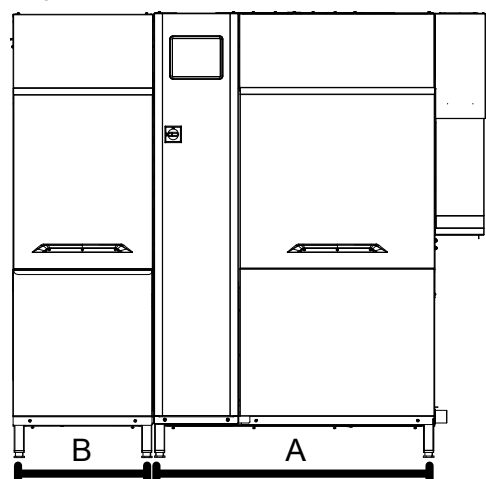

79"

- 250 racks/hour

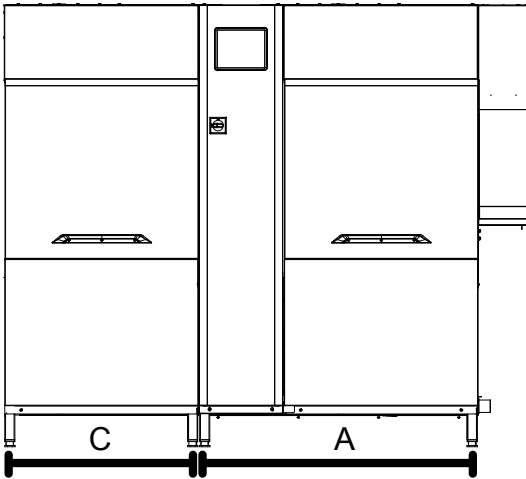

Possible drying zone added only at the machine outfeed after the rinse zone.

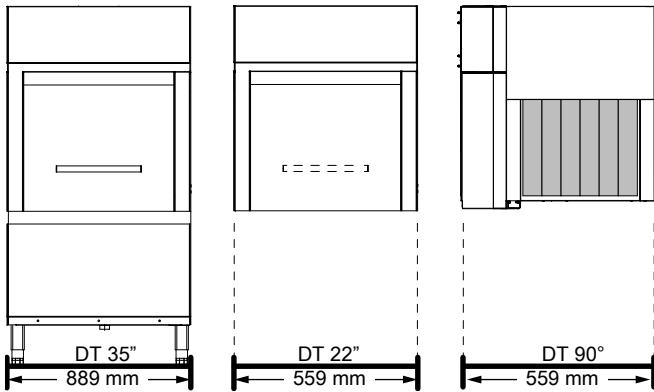

G.4 Description of machine modules

The machine consists of the following zones:

- wash and rinse zone in the same module.

It can be integrated with the following units:

- prewash zone (medium or large modules);
- energy recovery/steam suppression device;
- drying zone.

G.4.1 Wash zone

Water with the addition of detergent is sprayed on the dishes in the wash zone through an upper and lower wash arm system.

The purpose of this function is to remove all residuals of food from the dishes. Washing is carried out with water circulating at a temperature of 55-65°C / 131-149°F.

G.4.2 Rinse zone

Water with the addition of rinse aid is sprayed on the dishes in the rinse zone through a system of arms equipped with special nozzles.

The purpose of this function is to remove all residuals of detergent deriving from the previous wash phase. Rinsing is carried out with clean water coming from the water system, heated to a max. temperature of 80-90°C / 176-194°F. The high temperature ensures satisfactory drying and careful neutralization of bacteria. The addition of rinse aid allows the water to easily run off the dishes, thus favouring the drying process.

G.4.3 Prewash zone

Water is sprayed on the dishes in the prewash zone through an upper and lower prewash arm system. The purpose of this function is to remove the larger food residuals, preparing the dishes for the subsequent wash phase. Prewash is carried out with water circulating at a max. temperature of 35°C / 95°F in order to prevent food residuals (in particular proteins) from sticking to the dishes.

G.4.4 Drying zone

The dishes come under a flow of hot air in the drying zone, facilitating the water evaporation process. Drying occurs with hot air at a temperature of 50-60°C / 122-140°F. This function can be added at the machine out-feed after the rinse zone.

G.4.5 Energy recovery/steam suppression device

The rack-type dishwasher can be supplied with an energy recovery/steam suppression.

ESD	It consists of a fan and an air-water heat exchanger. By means of the fan, the steam present inside the wash zone is exhausted and condensed thanks to the heat exchange with the cold water entering. The condensed steam (water) is recovered in the wash tank. This also offers the advantage of heating the cold water entering, recovering a part of the heat that would otherwise be dissipated into the environment.
------------	---

H CONTROL PANEL DESCRIPTION

H.1 Control panel overview

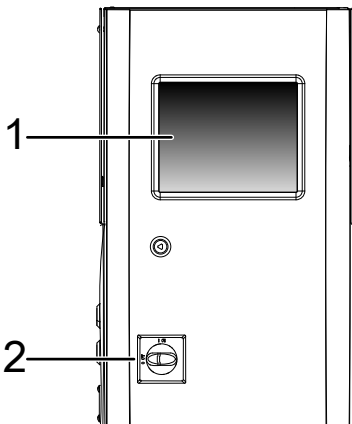

- 1 Touch screen with direct selection of functions. Touch the selected icons to activate the corresponding functions.
- 2 Depending on the model:
- switch disconnector or emergency switch.

H.2 Touch screen description

The machine works using a touchscreen with touch-sensitive icons.

Touch the icons on the screen to activate the requested actions or to see information related the machine, the wash cycle or any malfunctions.



NOTE!









This type of touch screen allows you to start, stop or change some settings in all of normal work conditions:

- hands with gloves;
- wet or dirty fingers.

Main touch screen icons

	Lower wash speed icon
	Medium wash speed icon
	Higher wash speed icon

Main touch screen icons (cont'd.)

	Pause icon. Touch it again to start the wash speed previously set.
	Touch this icon to activate "Pop Up menu"
	Touch this icon to deactivate "Pop Up menu"
	Touch this icon to come back to the previous menu
	Touch this icon to confirm your selection
	Touch this icon to scroll up the screen page
	Touch this icon to scroll down the screen page
	This icon appears when you have set a function and you want come back to the "Pop Up menu"

Pop Up menu

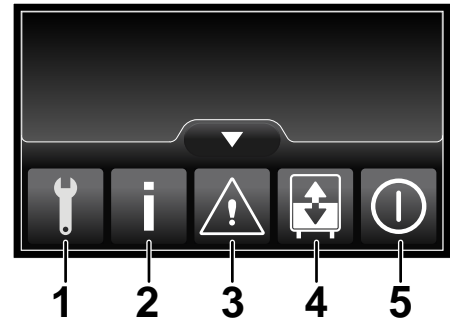

1	"Service" menu, protected by a password.
2	"Information" menu
3	"Alarm" menu
4	"Drain and Refill" menu
5	"Shutdown" menu

I START UP

I.1 Positioning and fitting of the tank components

Before starting the machine, check the fitting of filters and overflows of:

1. prewash 22" module, if present;

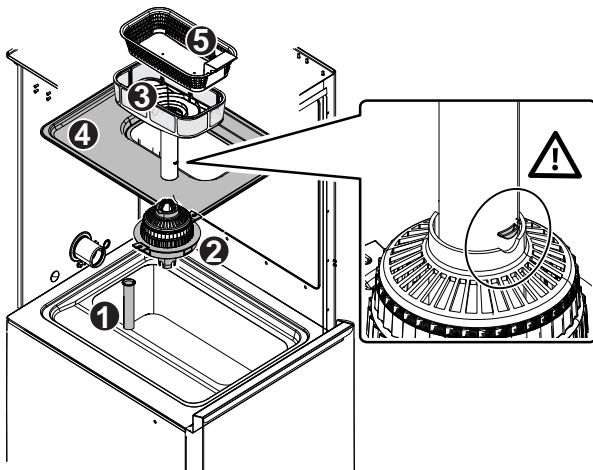

2. prewash 35" module, if present;

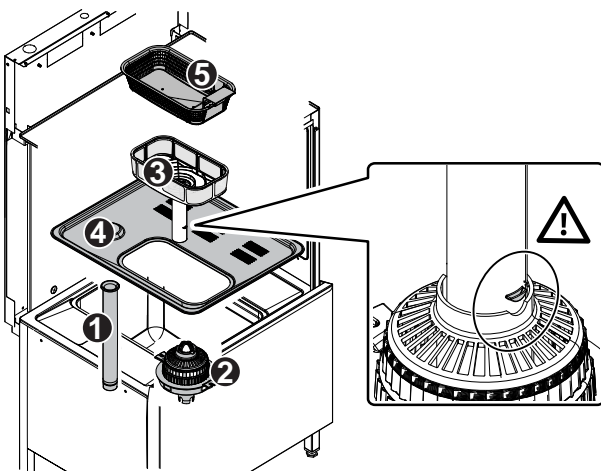

3. wash module;

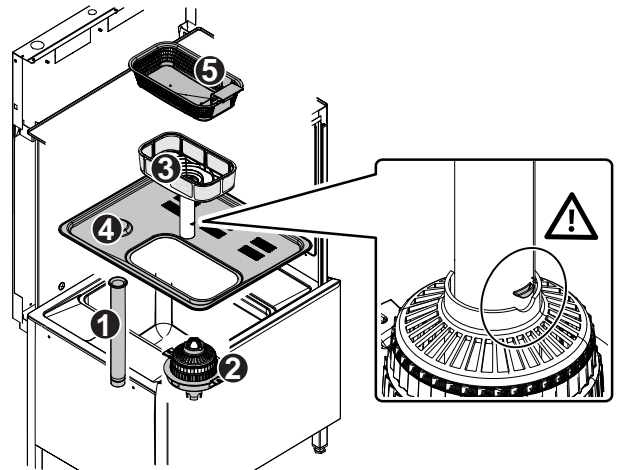

I.2 Positioning and fitting of the washing and rinse arms

Before starting the machine, check the fitting of upper and lower arms of:

1. prewash 22" module (if present);

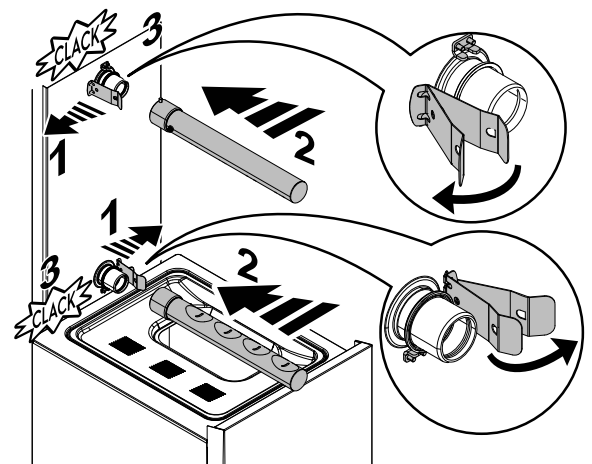

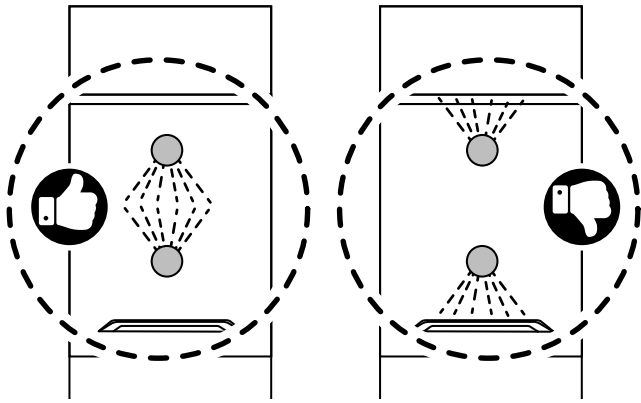

2. prewash 35" (if present) and wash module;

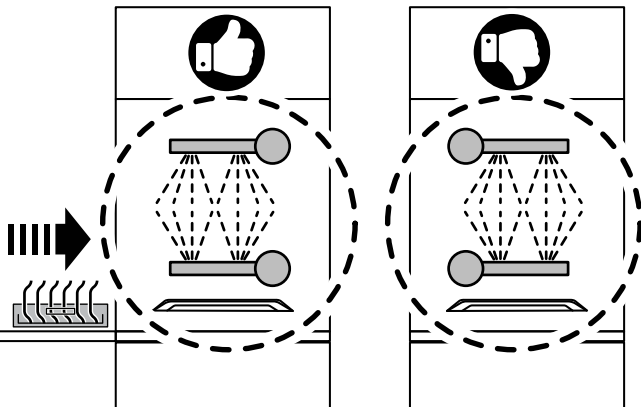
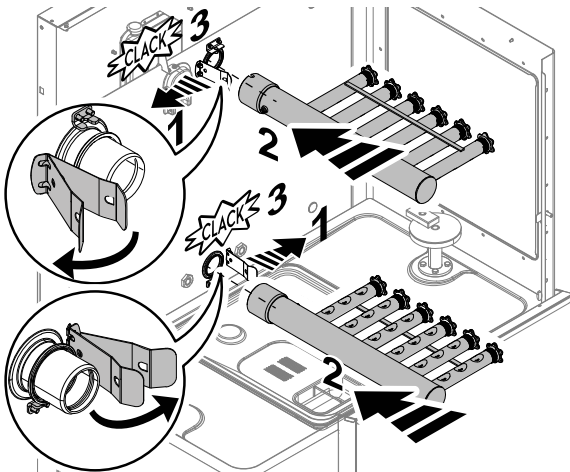

3. the arms of rinse module.

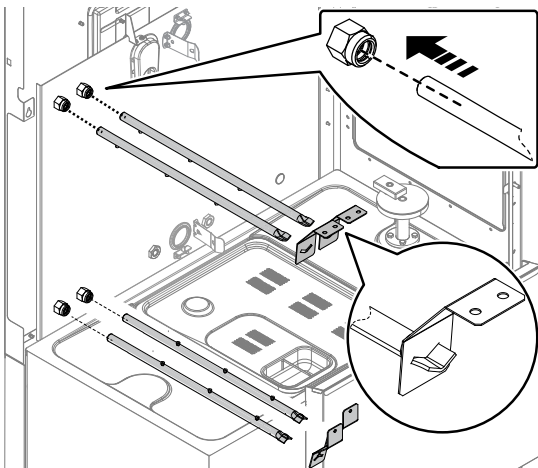

I.3 Starting

- Make sure all the types of curtains, provided for the machine model, are correctly fitted. Close the doors of the various machine modules.

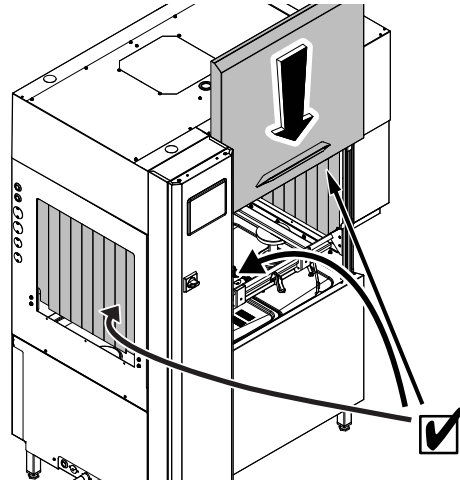

- Open the water supply taps.

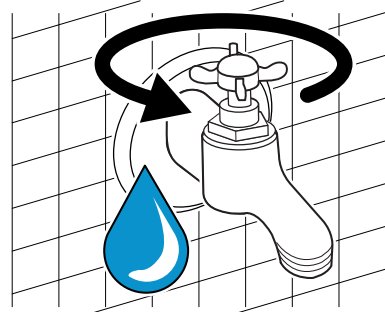

- Check the detergent or rinse aid containers. Refill or replace them with new ones in order to always obtain the good washing results.

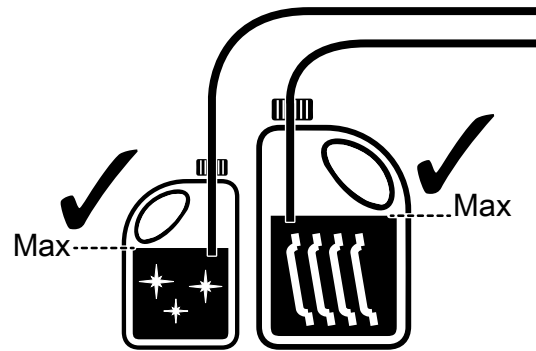

NOTE!

To obtain excellence washing performance, use detergent, rinse aid and descaling agent suggested by Electrolux Professional. In the Electrolux Professional web site, open the "Accessories and Consumables" web page and navigate into the dishwashing equipment tab to order most suitable detergents and accessories.



CAUTION

The use of “foaming/nonspecific” detergents or in any case detergents used in different ways from that prescribed by the manufacturer, can cause damage to the dishwasher and compromise the washing results.

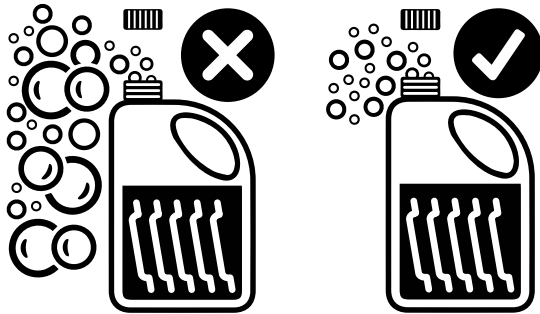

WARNING

When using chemicals, comply with the safety notes and dosage recommendations printed on the packaging. Refer to the chapter *A.3 Personal protection equipment* for handling chemical products.

- Turn clockwise the switch disconnector from position “O” to “I” to power the machine.

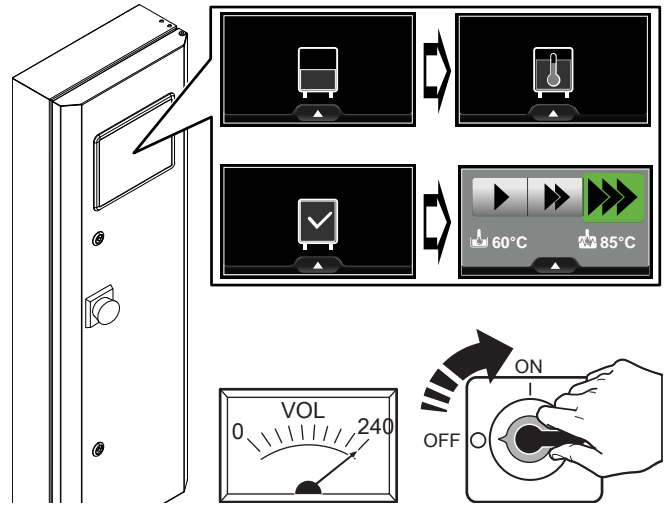
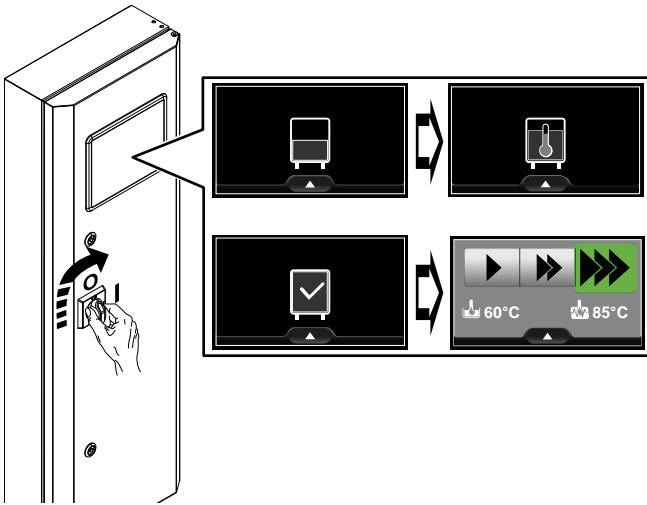

1.4 Fitting curtains

With the machine switched off and cold, fit or refit the curtains as illustrated below.

Machine curtains position

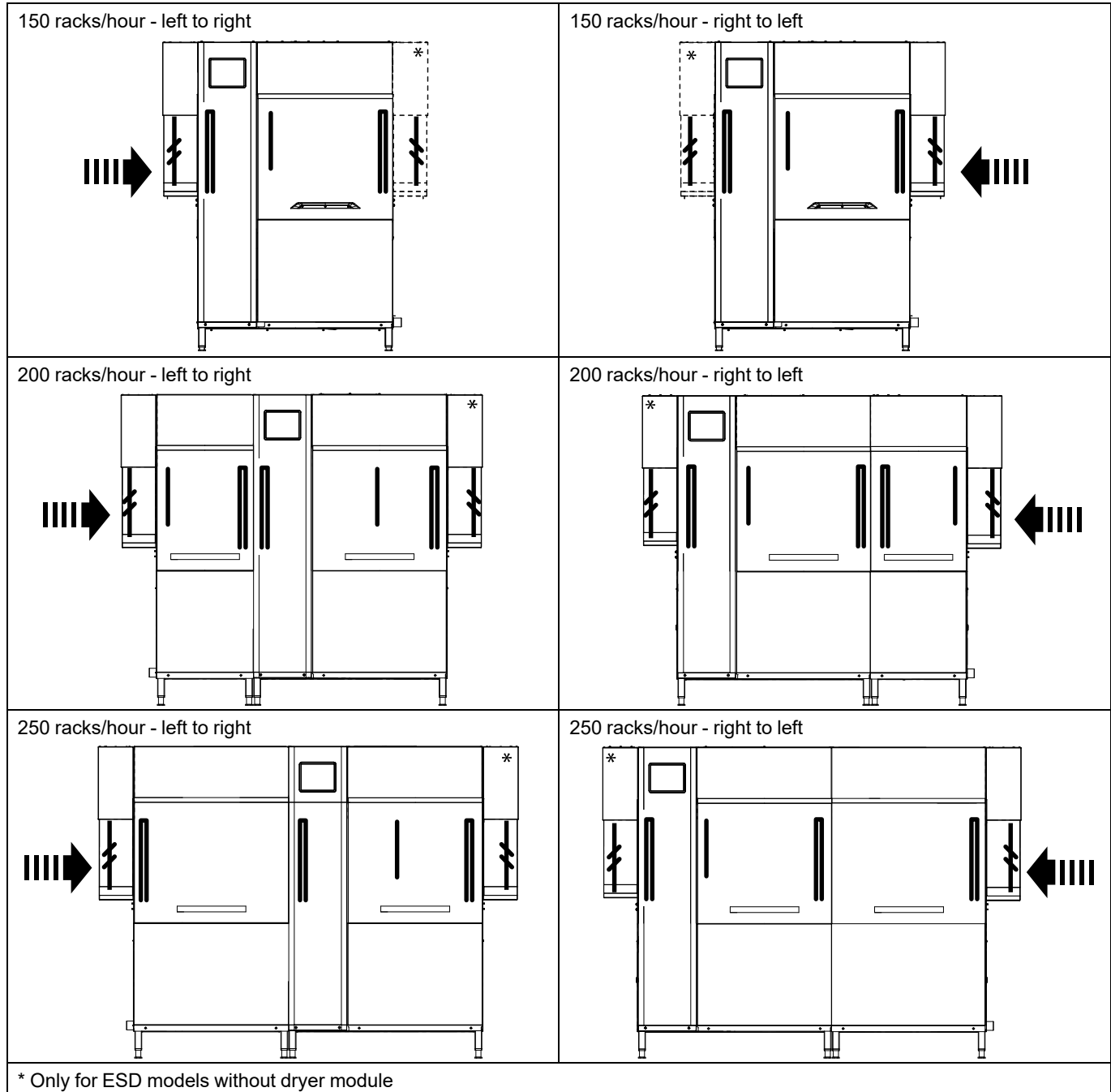

Type of curtains

Double long	Single short	Single long

Curtains fitting

<p>Fasten the curtains with the flat part against the hook</p>	Hood curtains	
	<p>Left to right</p>	<p>Right to left</p>

J OPERATION

J.1 Loading dishes on racks

The rack-type dishwasher is suitable for washing dishes, glasses, cups, cutlery, trays, containers and receptacles in plastic and/or steel used for preparing, cooking and serving; as well as a wide variety of ceramic and/or metal cooking utensils. However it is advisable not to wash decorated dishes or place silverware in contact with other metals.



IMPORTANT

All the dishes must be arranged in the special racks in order to be washed. Do not place dishes directly on the rack conveyor system. Before inserting the racks in the machine, clear the dishes of any food residuals and rinse them with cold or warm water (at a max. temperature of 35°C), using a manual prewash spray.

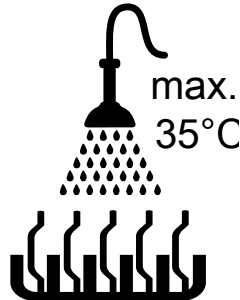
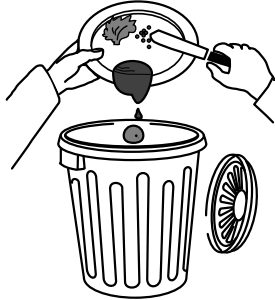

IMPORTANT

This machine must only be used for washing dishes, containers, etc. (see above) do not use it to wash animals or food (e.g. fruit, vegetables, meat or fish).

Blue rack with green spacer for 16 glasses.

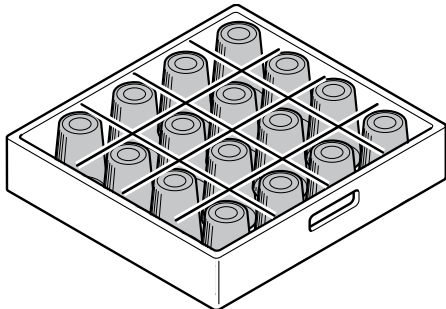

Yellow rack for 18 dishes.

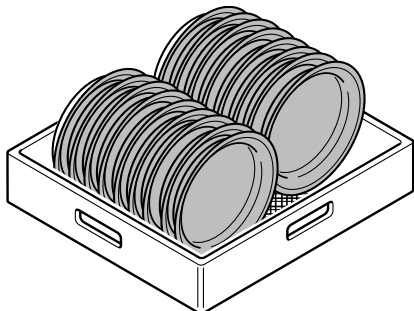

CAUTION

Failure to remove the residuals of detergent possibly used for manual prewash can cause malfunctioning of the dishwasher and compromise washing results.

Arrange the dishes on the racks, observing the following:

- Hollow containers such as cups, glasses, pots, etc., must be arranged with openings facing downwards, to avoid collecting water inside.
- Avoid to arrange or overfill the rack of items too close, because this cause a bad washing results. The washing arms of the machine with several angled water jets are not able to perfectly clean the dishes.

- Arrange dishes and pans on the racks following the feed direction of the rack conveyor system.
- To keep the best performance of the washing cycle, do not wash alternately racks with dishes, pans and trays.

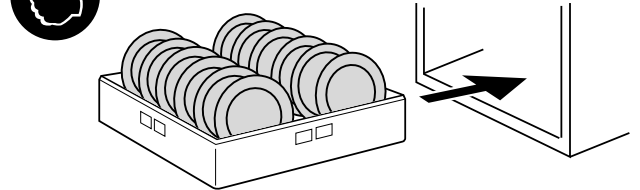
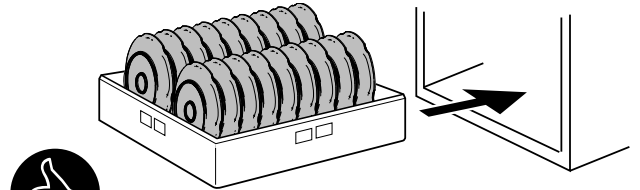

Fig. 2 Dish position

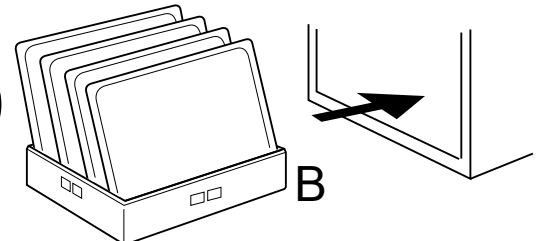
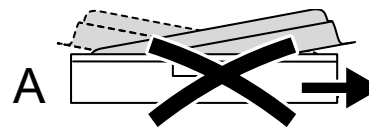

Fig. 3 Pan position



CAUTION

If the pans are inserted as in point "A" (Fig. 3), the curtains can lift the lighter pans causing a conveyor jam or the pans can cool the water of wash tank due to the transfer of the cold water from the prewash module. If pans are inserted as in point "B" (Fig. 3), there is no risk of a conveyor jam or a cooling water of the wash tank.

- Position the trays on the racks with the long side in the feed direction of the conveyor system, leaving the last rack position free, since a tray positioned there could collide with the wall of the machine.

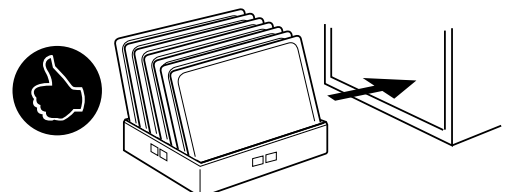
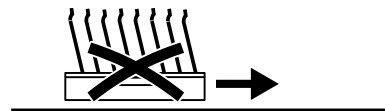

Fig. 4 Trays position



NOTE!

- To facilitate the flow of water leave a space of about 100 mm between each pan.
- The **EMR20.....M** models can achieve the performance level "**A₀ = 30**".
The operator must:
 - leave 1 meter distance between each racks when he inserts them into the machine;
 - select the proper pre-set speed¹.



WARNING

Danger of crushing.
Keep hands and arms away from the rack entry zone.

J.2 Daily activation



IMPORTANT

Refer to the chapter "1 Start up" before using the dishwasher.

Turn clockwise the main switch from position "O" to "I" to power the machine.

- During the filling phase, the screen, continuously, shows the exact step of the filling phase.

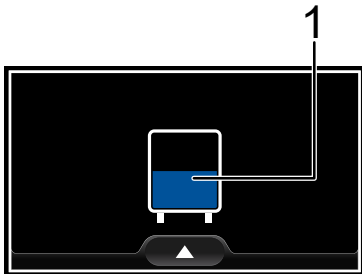

1 Animated water level icon of the tanks

- During the heating phase, the screen, continuously, updated its status.

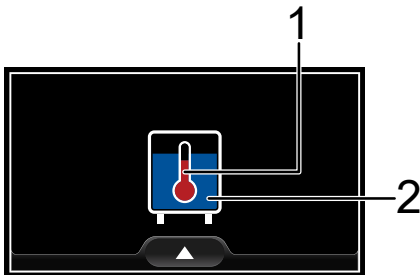

1 Animated thermometer icon

2 Animated water level icon of the tanks

- At the end of the filling and heating phase, the screen shows for some seconds the machine icon with a tick.
The tank and the boiler of the dishwasher are filled and the set temperatures have been reached.



- After some seconds, the screen shows the last selected washing speed, the water temperature of the tank and the boiler. The machine is now ready to use. You can start the washing cycle and choose 3 different washing speeds and take under control the washing temperature of the tank and the boiler.

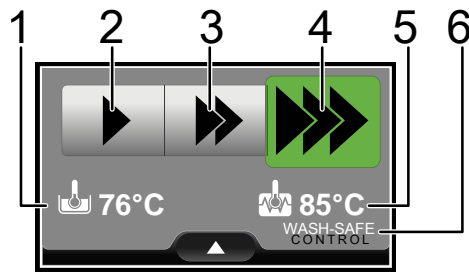

1	Temperature of the water inside the wash tank	
2	Wash speed 1 Conveyor at low speed	For heavily soiled dishes 18 dishes in "ceramic (china/porcelain)" with ø = 240 mm and 550 g each in the yellow rack NSF/ANSI 3 compliance
3	Wash speed 2 Conveyor at medium speed	For normally soiled dishes Medium or light loads DIN compliance
4	Wash speed 3 Conveyor at high speed	For lightly soiled dishes 16 plain cylindrical glasses with 160 g each and 2 mm thickness in the blue rack
5	Temperature of the water inside the boiler	
6	The logo "WASH-SAFE CONTROL" appears when the water temperature of the rinse is in compliance with machine parameters.	

- To start the washing cycle, touch the requested speed. The wash speed icon changes with the pause icon . Touch it again to pause the cycle.



- To modify the speed of the washing cycle, only touch the corresponding icon.

wash speed icon 1

wash speed icon 2

wash speed icon 3



IMPORTANT

To guarantee sanitization of the dishes, wash at least 3 empty racks at lowest speed. This allows all the machine to reach the working temperature. Repeat the procedure if the machine is stopped for a long time.





NOTE!

To wash very heavily soiled dishes, reduce further the wash speed 1. Insert some racks in the dishwasher and check the washing results. Call the Customer Care service to change the default dishwasher speed of washing.

1. Only a specialised technician can change the parameters to operate in this mode.



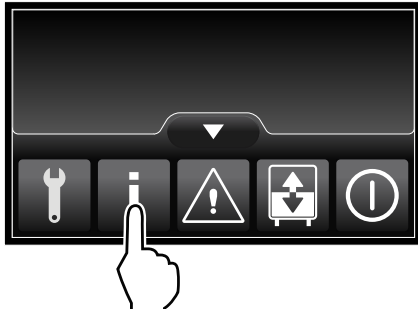

J.3 Info menu

During the daily use, the operator can enter into "Info" menu to see the machine status. When the operator enters into "Info Menu", the machine continues with the daily operations.

- Touch the icon  to activate the "Pop Up menu".
- Touch the "Info" icon  to enter into "Info" menu.



- Select the below categories:

	All detectable temperatures in the machine
	All detectable water levels and volumes in the machine
	If the installed, all water volumes detected by a flowmeter
	All useful information about the feeding system

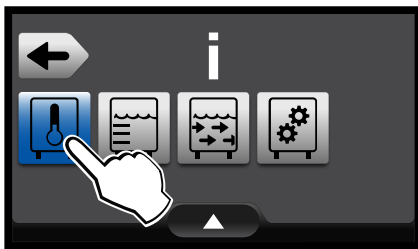



- Check the operating status of the machine and all available values.

Prewash temp	40°C	On
Wash temp	60°C	On
Boiler temp	85°C	On
Dryer temp	70°C	Off



NOTE!

To restore the main menu:

- touch the icon  to activate the "Pop Up menu" and then touch the "Home" icon ;
- do not touch the display for almost a minute. The display, automatically, returns to the main menu.

J.4 Wait rack

- If after the start of the washing cycle, the operator does not insert any racks, for a while, the conveyor continues operating while the pump stops and the screen shows to insert the rack.

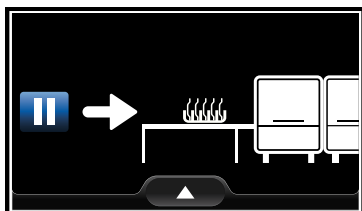

- Insert a new rack to restart the washing cycle. The screen comes back in the ready status. If necessary, the operator can change the washing speed.

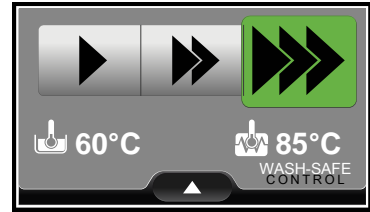

J.5 End limit switch activated

- When a rack reaches the end of the conveying system, it activates the "end limit switch" device. The machine stops immediately to work and the screen shows:

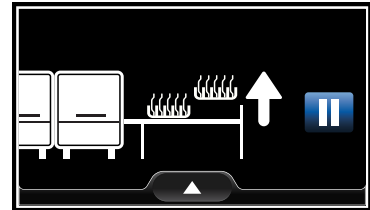

- Remove the rack, after some seconds the machine is ready to work and washing cycle starts again. The screen comes back in a "ready status".

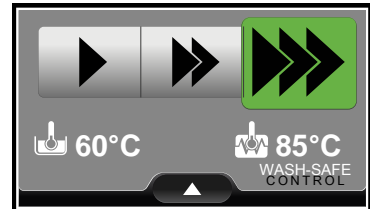

J.6 Door open

- When one or more doors are open, the screen informs you which door is open.

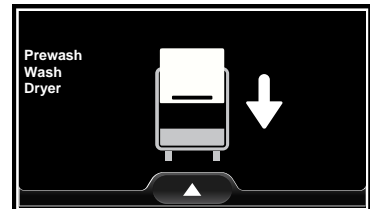

- Close all open doors. The screen comes back to the "ready status".

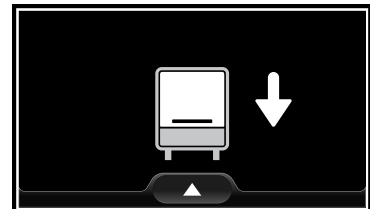

- Touch the wash speed icon to restart the washing cycle.

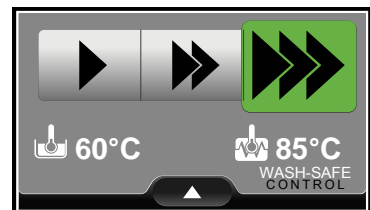

IMPORTANT

If the door is opened for a long time, wash at least 3 empty racks at lowest speed to guarantee sanitization of the dishes. This allows all the machine to reach the working temperature.

J.7 Emergency switch

- If the emergency switch push button is installed and activated, the motor conveyor and the pumps stop immediately and the screen shows to deactivate the emergency switch push button.

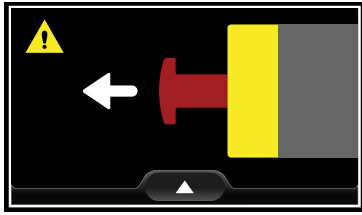

- Once deactivated the emergency switch push button, the machine comes back to the previous status.

J.8 Clean tank filter

- The tank filter of machine is not cleaned. The screen show you where the error occurs. Remove the filter and clean it. When the tank filter is correctly fitted, touch the confirm icon to continue the wash phases.

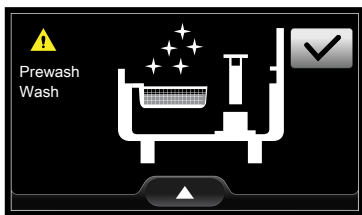

J.9 Drain tanks

- The dishwasher has processed more than 500 racks and it is necessary to change the water of the tanks. Activate the "Pop Up menu" and touch the "Drain and Refill" icon. Refer to chapter J.10 *Automatic drain and refill* for additional information. The display shows you how to remove the tank overflow.

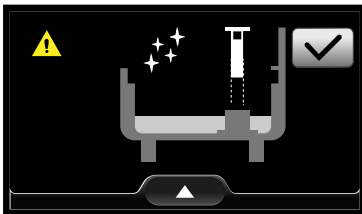

NOTE!
To disable this message please call Customer Care Service.

J.10 Automatic drain and refill

If during the normal daily washing phase it is necessary to change the water of the tanks, activate the "Pop Up menu" and touch the "Drain and Refill" icon.

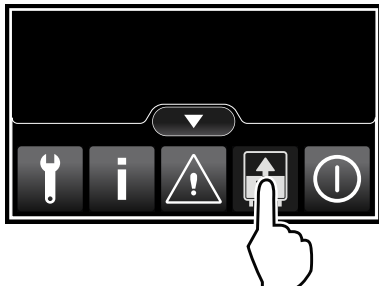

The screen shows all the steps that the machine will do to execute the "Drain and Refill" function.

- Drain the water from the tanks.
- Refill the water in the tanks.
- Restore the water temperature.

- Phase completed .

Touch the icon to confirm the function.

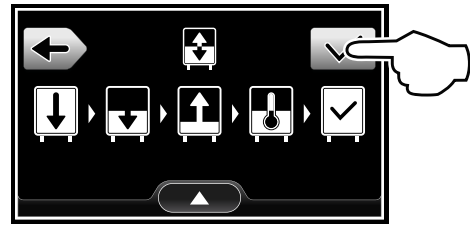

The Drain and Refill function is available for all the tanks of the machine. If you want to exclude one or more tanks, touch the corresponding icon to deselect it.

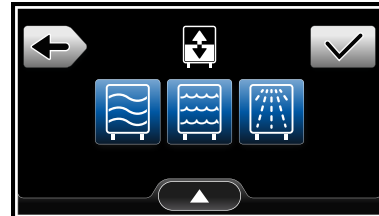

Module	Enabled (on the screen, the icon appears in blue)	Disabled (on the screen, the icon appears in grey)
Prewash ¹		
Wash		
Rinse		

1. Depending on the model, the screen can display the icon due to there is a prewash module installed.

After you have selected the tanks need to be refilled, touch the icon to start the function. When the "Drain and Refill" cycle has finished, the machine is ready to use.

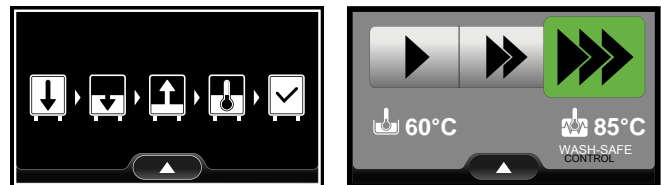

J.11 Shutdown function

Touch the icon to activate the Pop Up menu. Touch the OFF icon to enter in the shut down menu. It is possible select till 5 different shut down options. In the below table there is a short description of each option.

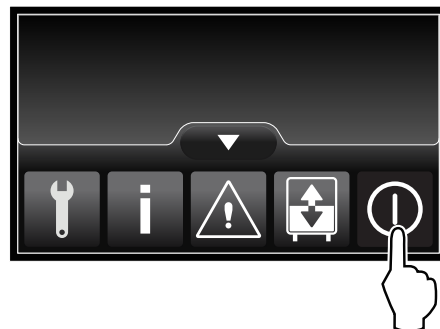

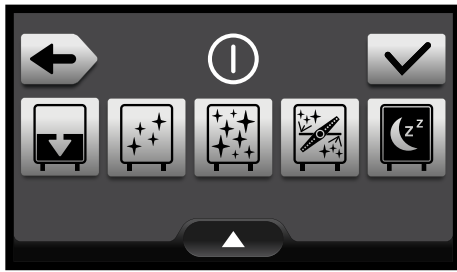

Shutdown option	Enabled (on the screen, the icon appears in blue)	Disabled (on the screen, the icon appears in grey)
Drain only		
Drain and clean with cold water.		

Shutdown option	Enabled (on the screen, the icon appears in blue)	Disabled (on the screen, the icon appears in grey)
Sanitization. Drain and clean with hot water.		
Delime cycle. ¹		
Power Off.		

1. Only specialised personnel can execute this cycle.

After you have selected the requested shutdown option, touch the confirm icon to start it.

K DAILY CLEANING



WARNING

Refer to “*Safety Information*”.

K.1 Appliance cleaning

Cleaning must be carried out after every day of use. Use hot water, a neutral detergent/cleaner if necessary, and a soft brush or sponge. If another type of detergent is used, carefully follow the producer's instructions and observe the safety rules given in the information sheets provided with the product or substance.

In order to reduce the environmental impact of pollutants it is advisable to clean the appliance (externally and, where necessary, internally) with products that are more than 90% biodegradable.



CAUTION

Do not use steel wool or similar material to clean stainless-steel surfaces. Do not use detergents containing chlorine.



WARNING

When using chemicals, comply with the safety notes and dosage recommendations printed on the packaging. Refer to the chapter *A.3 Personal protection equipment* for handling chemical products.



K.2 Internal cleaning

At the end of a day's work carry out the instructions listed below.

1. Touch the ON/OFF icon to empty out the dishwasher tanks and switch off the machine.

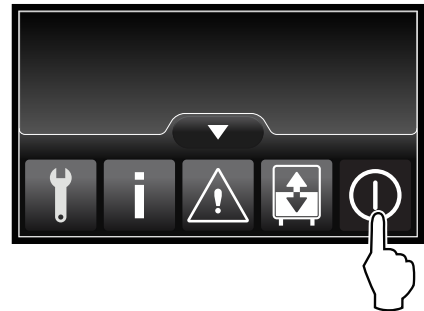

2. Select one options of the shutdown menu and touch the icon to confirm the option.

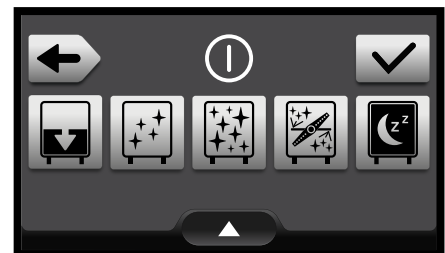

Shutdown options

	Drain only
	Drain and clean with cold water.
	Drain and clean with hot water.

3. At the end of the shutdown option, turn the switch disconnecter of the machine to “O”.
4. Close the water supply tap or taps (hot and cold).
5. Open the machine doors and remove:

- Tanks filters and overflows

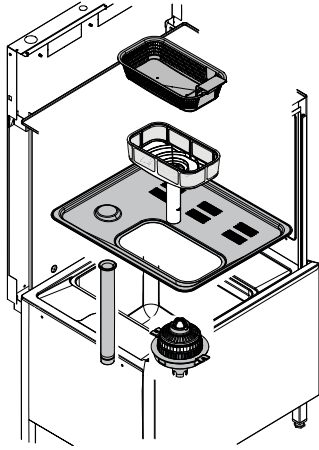

- Prewash and wash arms

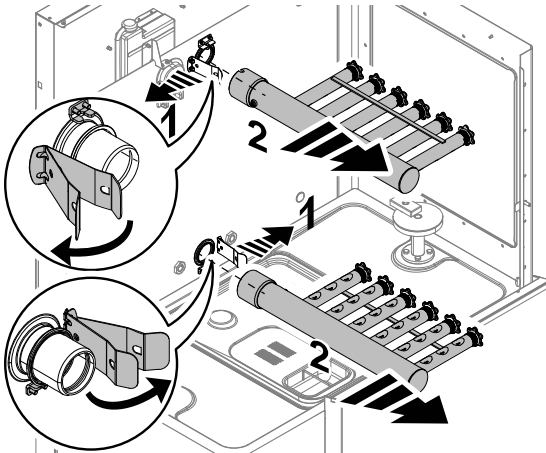

- Rinse arms

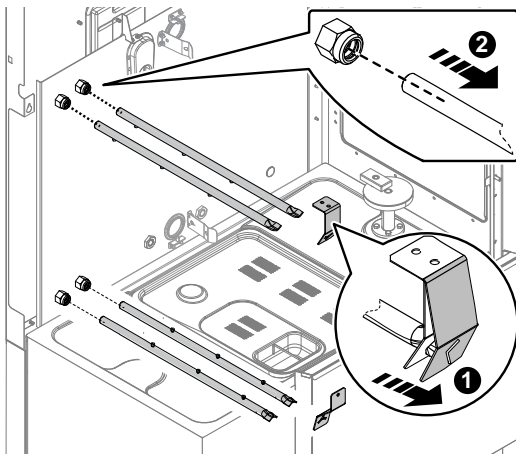

- Curtains

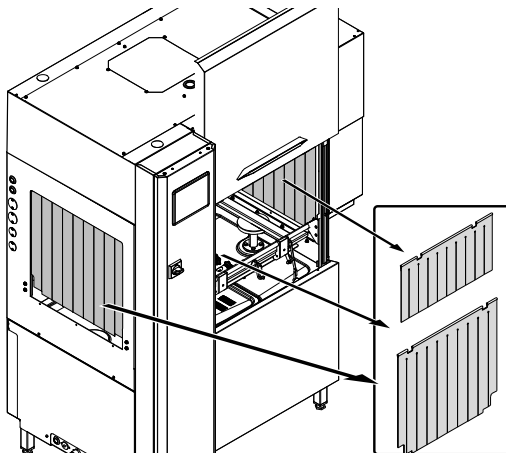

6. Carefully clean all items with hot water and neutral detergent. For better result use a brush with a plastic bristles and a sponge.

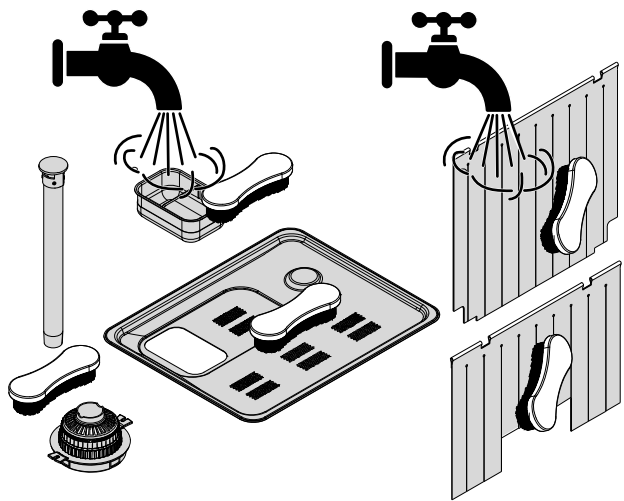
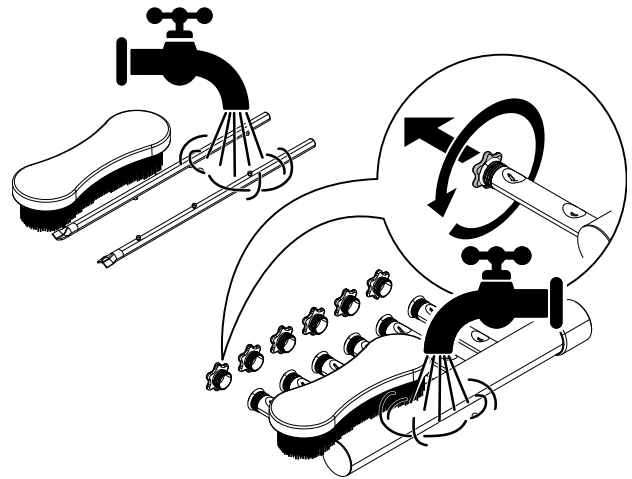

7. Clean the inside of doors with a damp cloth and neutral detergent.
8. At the end of cleaning operations, refit all the items previously removed.



NOTE!
Refer to chapter I *Start up* for more information.



9. Close the machine doors.
10. Clean inside the machine. Make sure to remove any residuals of detergent or food.

K.3 Manual drain

If you need to execute a manual drain to clean all the tanks deeply, proceed as follows:

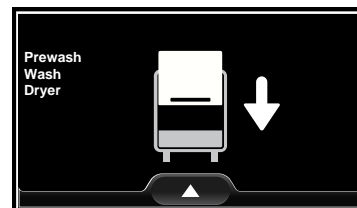
1. Open one or more doors. The "door open" warning appears in the screen.



2. Touch the icon  to activate the Pop Up menu.
Touch the icon  to activate the drain valves for 5 minutes.

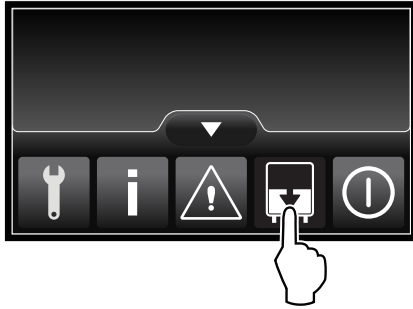

3. Once selected the manual drain cycle, the countdown appears on the screen. After 5 seconds the pop up menu deactivates.

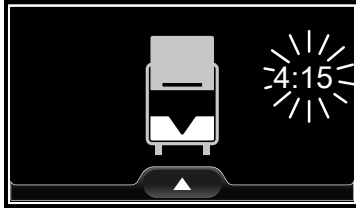

4. To exit from this option before the countdown end:
 - a. activate the pop up menu;
 - b. touch again the manual drain icon .
5. Close all open doors. The screen comes back to the "ready status".
6. Touch the wash speed icon to restart the washing cycle.

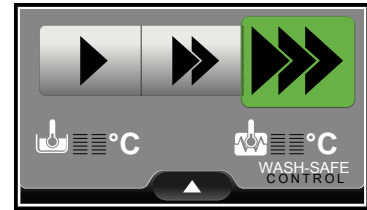

L MAINTENANCE

L.1 Maintenance intervals

The inspection and maintenance intervals depend on the actual machine operating conditions and ambient conditions (presence of dust, damp, etc.), therefore precise time intervals cannot be given. In any case, careful and periodical machine maintenance is advisable in order to minimise service interruptions.

L.1.1 Preventive Maintenance

Preventive Maintenance reduces downtime and maximizes machines efficiency.

Customer Care Service can provide advice on the best maintenance plan to be purchased based on the intensity of use and the age of the equipment.

It is advisable to stipulate a preventive and scheduled maintenance contract with the Customer Care Service.

L.2 Maintenance frequency

To ensure constant appliance efficiency, it is advisable to carry out the checks with the frequency given in the following table:

Maintenance, inspections, checks and cleaning	Fre-quency	Respon-sability
Ordinary cleaning • general cleaning of appliance and surrounding area	Daily	Operator
Ordinary cleaning • Every month descale the wash and rinse jets with vinegar.	Monthly	Operator
Ordinary cleaning • Every month descale the wash and rinse jets with scale remover.	Monthly	Service
Mechanical protection devices • check their condition and for any deformation, loosening or removed parts	Monthly	Service

Maintenance, inspections, checks and cleaning	Fre-quency	Respon-sability
Control • check the mechanical part, for cracks or deformation, tightening of screws: check the readability and condition of words, stickers and symbols and restore if necessary	Yearly	Service
Appliance structure • Descale the boiler, inside surfaces of the tank and the appliance piping.	Yearly	Service
Appliance structure • The internal hose of the rinse-aid and detergent peristaltic dispenser should undergo periodic maintenance.	Yearly	Service
Appliance structure • If present, clean the finned coil of the energy saving device.	Yearly	Service
Appliance structure • tightening of main bolts (screws, fixing systems, etc.) of appliance	Yearly	Service
Safety signs • check the readability and condition of safety signs	Yearly	Service
Electrical control panel • check the electrical components installed inside the electrical control panel. Check the wiring between the electrical panel and appliance parts.	Yearly	Service

Maintenance, inspections, checks and cleaning	Fre-quency	Respon-sability
Electrical connection cable and plug <ul style="list-style-type: none"> check the connection cable (replace if necessary) and plug 	Yearly	Service
General appliance overhaul <ul style="list-style-type: none"> check all components, electrical equipment, corrosion, pipes... 	Every 10 years ¹	Service

1. the appliance is designed and built for a duration of about 10 years. After this period of time (from commissioning) the appliance must undergo a general inspection and overhaul. Some examples of checks to be carried out are given below.

L.3 Periods of non-use

If the appliance is not going to be used for some time, take the following precautions:

- close the water supply tap(s), if present;
- disconnect the power supply or remove the plug from the power socket, if present;
- completely drain the tank(s);
- remove and carefully clean the filters;
- completely drain the boiler;
- completely drain the incorporated dispenser hoses. Remove them from the containers;
- carefully clean the internal parts of the appliance;
- clean the cabinet, going over all the stainless steel surfaces vigorously with a rag moistened with paraffin oil to create a protective film;
- periodically air the premises.

L.4 Machine disposal

At the end of the product's life cycle, make sure the equipment is not dispersed in the environment. The equipment must be disposed of in compliance with current regulations in the country of use.

All metal parts are in stainless steel (AISI 304) and removable. Plastic parts are marked with the letters of the material.



The symbol  on the product indicates that this product should not be treated as domestic waste, but must be correctly disposed of in order to prevent possible negative consequences for the environment and the human health.

Regarding the recycling of this product, please contact the sales agent or dealer of your product, your Customer Care service or the appropriate waste disposal service.

L.5 Delime cycle (not available in all models)





IMPORTANT

Before to start the "Delime Cycle", make sure to close all doors and check if "emergency switches" are deactivated.



To execute the delime cycle, proceed as follows:

1. Insert the delime hose, present in the machine, in the container of the descale agent.

2. With the machine in "ready status", touch the icon  to activate the Pop Up menu.

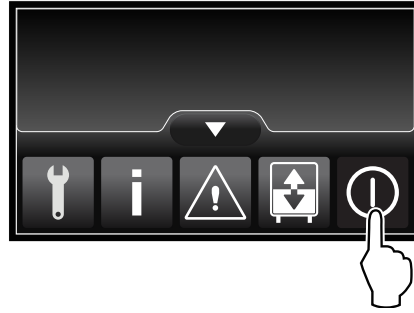
Touch the OFF icon  to enter in the shut down menu.



3. Touch the delime cycle icon  and confirm your choice .

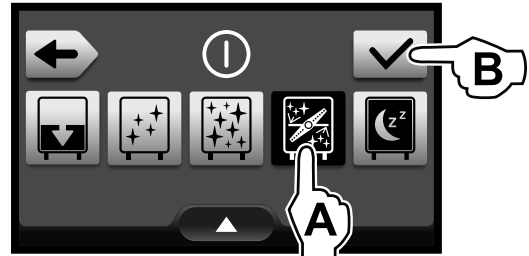

4. Insert the high level password to start the delime cycle and confirm it .

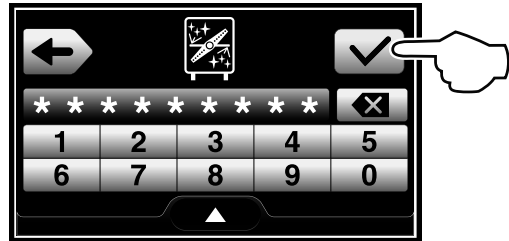

5. During the delime cycle, the screen, continuously, updated its status.

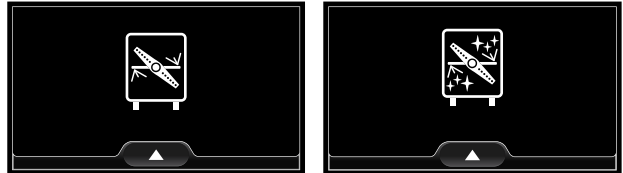

6. At the end of Delime cycle, the machine turns off.

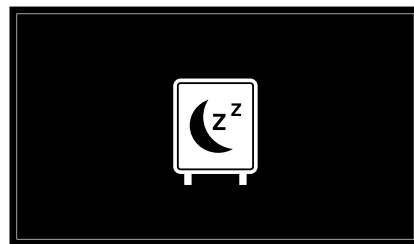

IMPORTANT

The delime cycle lasts about 2 hours. During this phase the machine must not be opened and no other command can be activated until completion of the cycle in progress. If the machine is turned off during the delime cycle, at the next restart the cycle will resume exactly from where it was interrupted, until its completion.

**NOTE!**

To obtain excellence washing performance, use detergent, rinse aid and descaling agent suggested by Electrolux Professional. In the Electrolux Professional web site, open the "Accessories and Consumables" web page and navigate into the dishwashing equipment tab to order most suitable detergents and accessories.

M TROUBLESHOOTING**M.1 Common faults****Overflow missing**

- If the machine does not stop to fill the water into the tanks, check if the overflow is correctly installed or missing.

The display show you where the error occurs and how to fix it.

When the overflow is fitted correctly, touch the confirm icon

to continue the filling and heating phases.

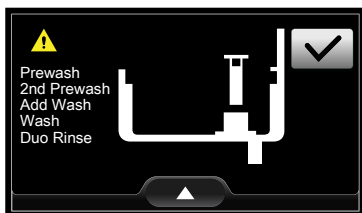
**Closed water inlet taps (cold - hot)**

- If the inlet water taps are closed, you must open them. The display shows you where the error occurs and how to fix it.

When the water inlet tap is opened, touch the confirm icon

to continue the filling and heating phases.

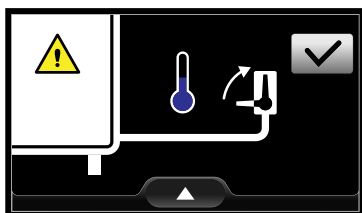
**Rinse arms missing**

- The rinse arms of machine are not correctly fitted or missing. The display show you where the error occurs and how to fix it.

When the rinse arms are correctly fitted, touch the confirm icon to continue the filling and heating phases.

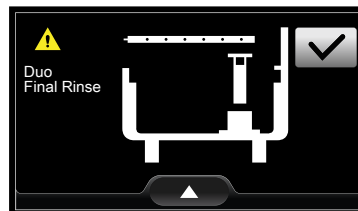
**Tank filter missing**

- The tank filter of machine is not correctly fitted or missing.

The display show you where the error occurs and how to fix it.



When the tank filter is correctly fitted, touch the confirm icon

to continue the wash phases.

**M.2 General troubleshooting**

Anomaly	Type of anomaly	Possible causes	Actions
The dishwasher does not start	Blocking	The dishwasher is not connected to the main power supply.	Check if the appliance main circuit breaker is in ON position.
The dishwasher does not stop to fill the water into the tank.	Message to Operator. Not blocking	Overflow missing 	Check if the overflow is correctly installed. When the overflow is fitted correctly, touch the confirm icon to continue the filling and heating phases.
The dishwasher is not able to fill the wash tank with water.	Message to Operator. Not blocking	The inlet water tap is closed. 	Open the water inlet tap. When the water inlet tap is opened, touch the confirm icon to continue the filling and heating phases.

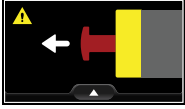
Anomaly	Type of anomaly	Possible causes	Actions
The dishwasher does not wash well.	Loss of performance.	No scrape action before putting dishes in the racks	Scrape dishes before putting them in the racks.
		The wash arms are clogged by solid food remains. Residual food has not been removed from dishes.	Check if the wash jets are clogged by solid food remains.
		The wash arms are not properly installed.	Check the integrity of the wash arms. Remove and fit again the wash arms.
		The dishes are not correctly placed in the racks.	Check if the dishes are correctly placed in the racks.
		The dosing of detergent is not correct.	Call detergent and rinse aid service centre.
		The detergent tank is empty.	Check that there is detergent in the container and if necessary top it up.
		Detergent pump does not work.	Call detergent and rinse aid service centre.
		The wash tank suction filter is dirty.	Clean wash tank suction filter thoroughly.
Glasses and dishes are not dried properly.	Loss of performance.	The container of rinse aid is empty.	Check that there is rinse-aid in the container and if necessary top it up.
		Rinse aid pump does not work.	Call detergent and rinse aid service centre.
		The water temperature of the rinse module is low.	Check if the water temperature of the rinse module is between 82°C - 90°C.
		If present, the drying module does not work properly.	If present, check if hot air comes out from the drying module.
		The curtains are missing.	Check if the curtains are correctly positioned.
		Foamy detergent present in the wash tank.	Check if the dishes were not immersed in foamy detergent (e.g. hand wash detergent) before being put in the dishwasher. Only use "non-foaming" products for professional dishwashers.
Condensation on glasses.	Loss performance.	The container of rinse aid is empty.	Check that there is rinse-aid in the container and if necessary top up.
		Rinse aid pump does not work.	Call detergent and rinse aid service centre.
Stains on the glasses.	Loss of performance.	Foamy detergent present in the wash tank.	Only use "non-foaming" products for professional dishwashers.
		The dosing of rinse aid is not correct.	Call detergent and rinse aid service centre.
		the hardness of the water is too high or too low.	Adjust the amount of detergent and rinse aid. Call detergent and rinse aid service centre.
Excessive foam in the tank.	Loss performance.	Residuals of food or detergent, used for manual prewash, remains in the dishes.	Remove residuals of food or detergent from the dishes.
		Wash water temperature is too low.	Check if the water temperature of the wash module is between 55°C - 65°C. Call detergent and rinse aid service centre to set the temperature in according to the detergent specifications.
		Foamy detergent present in the wash tank.	Empty and refill the tank with water until the foam has been removed.
Smears or spots on the glasses.		Too much rinse-aid.	Reduce the amount of rinse-aid. Call detergent and rinse aid service centre.
Low pressure from rinse arms.	Loss of performance	The water pressure after pressure reducer is less than 1 bar.	Call service centre.
The dishwasher is switched off, but the appliance continues to fill water.	Loss of performance	Inlet valve is damaged.	Close the water supply tap or taps and call service centre.

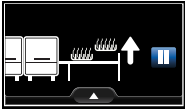
Anomaly	Type of anomaly	Possible causes	Actions
<p>The display shows to deactivate the emergency switch push button.</p>  <p>Once deactivated the emergency switch push button, the display shows the same anomaly.</p>	Blocking	The emergency switch push button does not work.	Call service centre.
<p>The display shows to close the door.</p>  <p>Once closed the door, the display shows the same anomaly.</p>	Blocking	The magnetic switch door does not work.	Call service centre.
<p>The display shows to remove the rack from the rack handling systems.</p>  <p>Once removed the rack, the display shows the same anomaly.</p>	Blocking	The end limit switch does not work.	Call service centre.

If the fault persists after carrying out the above checks, contact the Customer Care Service, remembering to specify:

- A. the type of fault;
- B. the appliance PNC (product number code);
- C. the Ser. No. (appliance serial number).



IMPORTANT

The appliance PNC and serial number are essential for identifying the type of appliance and date of manufacture.



NOTE!

For detailed information about the troubleshooting see the complete user manual in the web site.

N ALARMS AND WARNINGS

N.1 Introduction

The machine is able to manage two types of faults:

- **Alarms**
Serious faults that stop the machine;
- **Warning**
Minor faults that do not stop the machine. The operator can decide to stop or continue the daily operation.

N.2 Alarms

When an alarm occurs, the machine stops immediately all activities and the display shows:

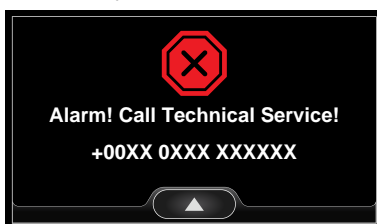

The operator can access to the pop up menu to see useful details for the technician.

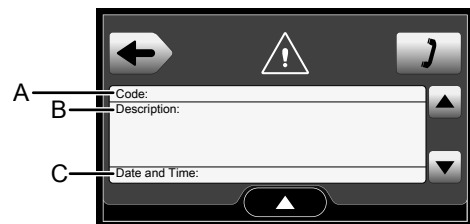
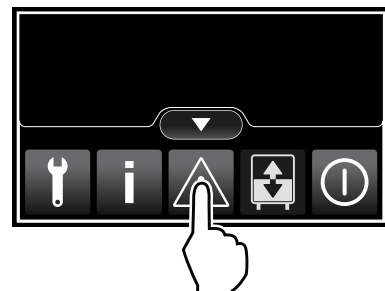

A	code of the alarm
B	Short description of the alarm
C	Date and time of the alarm
	Touch this icon to go back

	Touch this icon to visualize the telephone number of the Service Centre
	Touch this icon to scroll up or down the page of the display if there are more than one alarms.



NOTE!

- To exit from the alarm phase, turn counter-clockwise, from position "I" to "O", the switch disconnecter of the machine.
- Wait for about one minute and activate the machine again.
- If, after the start up phases, the same alarm stops again the machine, call the service.

N.3 Warning

When a warning occurs, the machine stops immediately all activities and the display shows:



The operator can decide to stop immediately the machine or continue even if a warning occurs.

The operator touches "stop" button:

- the machine goes to Alarm mode (Refer to N.2 Alarms);
- the display shows the telephone number of the Service Centre;
- the operator must call Service Centre.

The operator touches "continue" button:

- the machine does not consider the warning and it continues with daily operations;

- the display always shows a "Warning" triangle to inform the operator that the machine does not work properly;

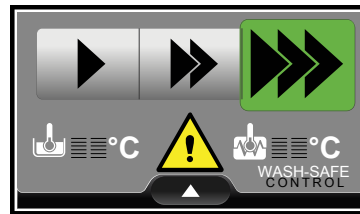

- the operator can access to the pop up menu to see useful details for the technician.

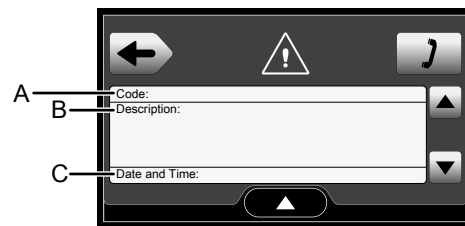
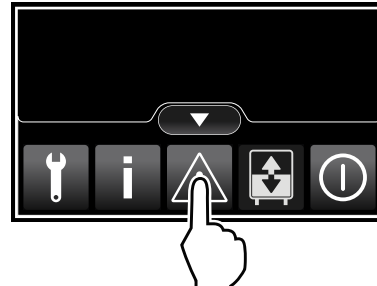

A	code of the alarm
B	Short description of the alarm
C	Date and time of the alarm
	Touch this icon to go back
	Touch this icon to visualize the telephone number of the Service Centre
	Touch this icon to scroll up or down the page of the display if there are more than one alarms.

CE