

Under Counter dishwasher



EN User manual *





*Original instructions

59566UL00- 2024.07

Foreword

 Read the following instructions, including the warranty terms before installing and using the appliance.

Visit our website www.electroluxprofessional.com and open the Support section to:

-  Register your product
 -  Get hints & tips of your product, service and repair information
-

The installation, use and maintenance manual (hereinafter Manual) provides the user with information necessary for correct and safe use of the appliance.

The following must not be considered a long and exacting list of warnings, but rather a set of instructions suitable for improving appliance performance in every respect and, above all, preventing injury to persons and animals and damage to property due to improper operating procedures.

All persons involved in appliance transport, installation, commissioning, use and maintenance, repair and disassembly must consult and carefully read this manual before carrying out the various operations, in order to avoid wrong and improper actions that could compromise the appliance's integrity or endanger people. Make sure to periodically inform the user regarding the safety regulations. It is also important to instruct and update personnel authorised to operate on the appliance, regarding its use and maintenance.

The manual must be available to operators and carefully kept in the place where the appliance is used, so that it is always at hand for consultation in case of doubts or whenever required.

If, after reading this manual, there are still doubts regarding appliance use, do not hesitate to contact the Manufacturer or the authorised Service Centre to receive prompt and precise assistance for better operation and maximum efficiency of the appliance. During all stages of appliance use, always respect the current regulations on safety, work hygiene and environmental protection. It is the user's responsibility to make sure the appliance is started and operated only in optimum conditions of safety for people, animals and property.



IMPORTANT

- The manufacturer declines any liability for operations carried out on the appliance without respecting the instructions given in this manual.
- The manufacturer reserves the right to modify the appliances presented in this publication without notice.
- No part of this manual may be reproduced.
- This manual is available in digital format by:
 - contacting the dealer or reference customer care;
 - downloading the latest and up to date manual on the web site www.electroluxprofessional.com;
- The manual must always be kept in an easily accessed place near the appliance. Appliance operators and maintenance personnel must be able to easily find and consult it at any time.

Contents

A	SAFETY INFORMATION	5
A.1	General information	5
A.2	General safety	5
A.3	Personal protection equipment	6
A.4	Water connection	6
A.5	Electrical connection	6
A.6	Appliance cleaning and maintenance	7
A.7	Machine disposal	7
B	GENERAL SAFETY INSTRUCTIONS FOR USA MARKET	7
B.1	General information	7
C	WARRANTY	9
C.1	Warranty terms and exclusions	9
D	GENERAL SAFETY RULES	9
D.1	Introduction	9
D.2	Mechanical safety characteristics, hazards	9
D.3	Protection devices installed on the appliance	9
D.3.1	Guards	9
D.3.2	Safety devices	9
D.4	Safety signs to be placed on the appliance or near its area	9
D.5	Instructions for use and maintenance	10
D.6	Reasonably foreseeable improper use	10
D.7	End of use	10
D.8	Residual risks	10
E	GENERAL INFORMATION	11
E.1	Introduction	11
E.2	Definitions	11
E.3	Machine and Manufacturer's identification data	11
E.4	How to identify the technical data	11
E.4.1	How to interpret the factory description	12
E.5	Type reference	12
E.6	Responsibility	12
E.7	Copyright	12
E.8	Keeping the manual	12
E.9	Recipients of the manual	13
F	NORMAL USE	13
F.1	Correct use	13
F.2	Characteristics of personnel enabled to operate on the appliance	13
F.3	Basic requirements for appliance use	13
G	TECHNICAL DATA	13
G.1	Main technical characteristics for single phase appliances	13
G.2	Main technical characteristics for three phases appliances	14
H	PRODUCT DESCRIPTION	16
H.1	General description	16
H.2	Machine overview	16
I	CONTROL PANEL DESCRIPTION	17
I.1	Control panel description	17
I.2	Basic Controls	17
J	OPERATION	18
J.1	Starting	18
J.2	Loading dishes on racks	18
J.3	Type of racks and loading	19
J.4	Operation	19
J.5	Wash cycles	20
J.6	Continuous water softener	21
J.6.1	Salt container	21
J.6.2	Fill the salt container	21
K	DAILY CLEANING	21
K.1	Appliance cleaning	21
K.2	End of service	22
L	MAINTENANCE	23
L.1	Maintenance intervals	23
L.1.1	Preventive Maintenance	23
L.2	Maintenance frequency	23
L.3	Periods of non-use	23
L.4	Boiler drainage (only for atmospheric versions)	23
L.5	Only for models with door lock device	23
L.6	Machine disposal	24
M	TROUBLESHOOTING	24
M.1	General troubleshooting	24

A SAFETY INFORMATION

A.1 General information

This appliance is intended to be used for commercial applications, for example in kitchens of restaurants, canteens, hospitals. It must be used for washing or drying (depending on the model) plates, dishes, glassware, cutlery and similar articles.

To ensure safe use of the appliance and a proper understanding of the manual it is necessary to be familiar with the terms and typographical conventions used in the documentation. The following symbols are used in the manual to indicate and identify the various types of hazards:



WARNING

Danger for the health and safety of operators.



WARNING

Danger of electrocution - dangerous voltage.



CAUTION

Risk of damage to the appliance or the product.



IMPORTANT

Important instructions or information on the product



Equipotentiality



Read the instructions before using the appliance







Clarifications and explanations

A.2 General safety

- The appliance must not be used by people (including children) with limited physical, sensory or mental abilities or without experience and knowledge of it, unless instructed in its use and supervised by those responsible for their safety.
 - Do not let children play with the appliance.
 - Keep all packaging and detergents away from children.
 - Cleaning and user maintenance shall not be made by children without supervision.
- For suitable personal protection equipment, refer to chapter “A.3 *Personal protection equipment*”.
- Several illustrations in the manual show the machine, or parts of it, without guards or with guards removed. This is purely for explanatory purposes. Do not use the machine without the guards or with the protection devices deactivated.
- Do not remove, tamper with or make illegible the safety, danger and instruction signs and labels on the machine.
- Do not remove or tamper with the machine’s safety devices.
- Unauthorised personnel must not enter the work area.
- Remove any flammable products or items from the work area.

A.3 Personal protection equipment

Summary table of the Personal Protection Equipment (PPE) to be used during the various stages of the appliance's service life.

Stage	Protective garments 	Safety footwear 	Gloves 	Glasses 	Safety helmet 
Transport	—	●	○	—	○
Handling	●	●	○	—	—
Unpacking	○	●	○	—	—
Installation	○	●	● ¹	—	—
Normal use	●	●	● ²	○	—
Adjustments	○	●	—	—	—
Routine cleaning	○	●	● ¹⁻³	○	—
Extraordinary cleaning	○	●	● ¹⁻³	○	—
Maintenance	○	●	○	—	—
Dismantling	○	●	○	○	—
Scrapping	○	●	○	○	—
Key:					
●	PPE REQUIRED				
○	PPE AVAILABLE OR TO BE USED IF NECESSARY				
—	PPE NOT REQUIRED				

1. During these operations, gloves must be cut-resistant. Failure to use the personal protection equipment by operators, specialized personnel or users can involve exposure to harm to health (depending on the model).

2. During these operations, gloves must be heatproof and suitable for contact with water and the substances used (refer to the safety data sheet of the substances used for the information regarding the required PPE). Failure to use the personal protection equipment by operators, specialised personnel or users can involve exposure to chemical risk and cause possible harm to health (depending on the model).

3. During these operations, gloves must be suitable for contact with chemical substances used (refer to the safety data sheet of the substances used for information regarding the required PPE). Failure to use the personal protection equipment by operators, specialized personnel or users can involve exposure to chemical risk and cause possible harm to health (depending on the model).

A.4 Water connection

- The operating water pressure (minimum and maximum) must be between:
 - 2 bar [200 kPa] and 3 bar [300 kPa] for appliances without rinse pump;
 - 0.5 bar [50 kPa] and 7 bar [700 kPa] for appliances with rinse pump;
- Make sure that there are no visible water leaks during and after the first use of the machine.

A.5 Electrical connection

- If the power cable is damaged it must be replaced by the Customer Care Service or in any case by specialised personnel, in order to prevent any risk.

A.6 Appliance cleaning and maintenance

- Depending on the model and type of electric connection, during maintenance operations, the cable and plug must be kept in a visible position by the operator carrying out the work.
- Do not touch the appliance with wet hands or feet or when barefoot.
- Do not remove the safety guards.
- Use a ladder with suitable protection for work on appliances with high accessibility.
- Respect the requirements for the various routine and extraordinary maintenance operations. Non compliance with the instructions can create risks for personnel.

Ordinary maintenance

- Do not clean the appliance with a water jet, a high pressure cleaner or a steam cleaner.

A.7 Machine disposal

- Work on the electrical equipment must only be carried out by a specialised personnel, with the power supply disconnected.
- Dismantling operations must be carried out by specialised personnel.
- Make the appliance unusable by removing the power cable and any compartment closing devices, to prevent the possibility of someone becoming trapped inside.
- Refer to “A.3 *Personal protection equipment*” for suitable personal protection equipment.
- When scrapping the machine, the “CE” marking, this manual and other documents concerning the appliance must be destroyed.



IMPORTANT

Save these instructions carefully for further consultation by the various operators.

B GENERAL SAFETY INSTRUCTIONS FOR USA MARKET

B.1 General information



IMPORTANT

To reduce the risk of fire, electrical shock, or injury when using your dishwasher, please follow these basic precautions including the following.

- Read all instructions before using your dishwasher.
- This Manual does not cover every possible condition and situation that may occur. Use common sense and caution when installing, operating, and maintaining this appliance.
- Do not sit, stand, or lean on the door or racks of a dishwasher.
- Store dishwasher detergent and rinse agents in clearly marked packages with “MSDS” (Material Safety Data Sheets) sheets in a safe place.
- **FOR YOUR SAFETY DO NOT STORE OR USE GASOLINE OR OTHER FLAMMABLE VAPORS AND LIQUID IN THE VICINITY OF THIS OR ANY OTHER APPLIANCE.**
- Your dishwasher uses hot water to clean and sanitize a variety of wares. Machine surfaces and wares become hot during and immediately following normal operations. Operators should use caution when loading and unloading wares from the machine. Refer to “A.3 *Personal protection equipment*” for suitable personal protection equipment.
- Do not touch the heating element during or immediately after use.
- The installation of this unit must be installed in accordance with local codes, or in the absence of local codes, installed in accordance with the applicable requirements in the National Electrical Code, “NFPA 70”, Canadian Electrical Code (“CEC”), Part I, “CSA

C22.1“, and Standard for Ventilation Control and Fire Protection of Commercial Cooking Operations, “NFPA 96“.

- BEFORE SERVICING, DISCONNECT THE ELECTRICAL SERVICE AND PLACE A RED TAG AT THE DISCONNECT SWITCH TO INDICATE WORK IS BEING DONE ON THAT CIRCUIT.



NOTE!

- Contact your authorized service company to perform maintenance and repairs.
- Using any parts other than genuine factory manufactured parts relieves the manufacturer of all warranty and liability.
- Manufacturer reserves the right to change specifications at any time without notice.



WARNING

- The equipment warranty is not valid unless the appliance is installed, started and demonstrated under the supervision of a factory trained installer.
- The unit must be installed by Personnel who are qualified to work with electricity and plumbing. Improper installation can cause injury to personnel and/or damage to the equipment.
- The unit must be installed in accordance with all National Codes governing plumbing, sanitation, safety and good trade practices.

SAVE THESE INSTRUCTIONS

C WARRANTY

C.1 Warranty terms and exclusions

If the purchase of this product includes warranty coverage, warranty is provided in line with local regulations and subject to the product being installed and used for the purposes as designed, and as described within the appropriate equipment documentation.

Warranty will be applicable where the customer has used only genuine spare parts and has performed maintenance in accordance with Electrolux Professional user and maintenance documentation made available in paper or electronic format.

Electrolux Professional strongly recommends using Electrolux Professional approved cleaning, rinse and descaling agents to obtain optimal results and maintain product efficiency over time.

The Electrolux Professional warranty does not cover:

- service trips cost to deliver and pick up the product;
- installation;
- training on how to use/operate;
- replacement (and/or supply) of wear and tear parts unless resulting from defects in materials or workmanship reported within one (1) week from the failure;
- correction of external wiring;
- correction of unauthorized repairs as well as any damages, failures and inefficiencies caused by and/or resulting from;
 - insufficient and/or abnormal capacity of the electrical systems (current/voltage/frequency, including spikes and/or outages);
 - inadequate or interrupted water supply, steam, air, gas (including impurities and/or other that does not comply with the technical requirements for each appliance);
 - plumbing parts, components or consumable cleaning products that are not approved by the manufacturer;

- customer's negligence, misuse, abuse and/or non-compliance with the use and care instructions detailed within the appropriate equipment documentation;
- improper or poor: installation, repair, maintenance (including tampering, modifications and repairs carried out by third parties not authorized) and modification of safety systems;
- Use of non-original components (e. g.: consumables, wear and tear, or spare parts);
- environment conditions provoking thermal (e. g. overheating/freezing) or chemical (e. g. corrosion/oxidation) stress;
- foreign objects placed in- or connected to- the product;
- accidents or force majeure;
- transportation and handling, including scratches, dents, chips, and/or other damage to the finish of the product, unless such damage results from defects in materials or workmanship and is reported within one (1) week of delivery unless otherwise agreed;
- product with original serial numbers that have been removed, altered or cannot be readily determined;
- replacement of light bulbs, filters or any consumable parts;
- any accessories and software not approved or specified by Electrolux Professional.

Electrolux Professional warranty will be void and manufacturer shall have no liability related thereto in case of any modification of the product or related hardware/software/programming.

Warranty does not include scheduled maintenance activities (including the parts required for it) or the supply of cleaning agents unless specifically covered within any local agreement, subject to local terms and conditions.

Check on Electrolux Professional website the list of authorized customer care.

D GENERAL SAFETY RULES

D.1 Introduction

The machines are provided with electric and/or mechanical safety devices for protecting workers and the machine itself.

Therefore the user must not remove or tamper with such devices. The Manufacturer declines any liability for damage due to tampering or their non-use.

D.2 Mechanical safety characteristics, hazards

The machine does not have sharp edges or protruding parts. The guards for the moving and live parts are fixed to the cabinet with screws, to prevent accidental access.

D.3 Protection devices installed on the appliance

D.3.1 Guards

The guards on the appliance are:



- fixed guards (e.g. casings, covers, side panels, etc.), fixed to the appliance and/or frame with screws or quick-release connectors that can only be removed or opened with tools;
- interlocked movable guards (door) for access inside the appliance;
- appliance electrical equipment access doors, made from hinged panels openable with tools. The door must not be opened when the appliance is connected to the power supply.



D.3.2 Safety devices

The appliance has:

- interlocks on the front panels giving access to inside the appliance;

D.4 Safety signs to be placed on the appliance or near its area

Prohibition	Meaning
	do not oil, lubricate, repair and adjust moving parts
	do not remove the safety devices
	do not use water to extinguish fires (placed on electrical parts)

Danger	Meaning
	danger of crushing hands
	caution, hot surface
	danger of electrocution (shown on electrical parts with indication of voltage)

D.5 Instructions for use and maintenance

Risks mainly of a mechanical, thermal and electrical nature exist in the appliance. Where possible the risks have been neutralised:

- directly, by means of adequate design solutions.
- indirectly by using guards, protection and safety devices.

Any anomalous situations are signalled on the control panel display.

During maintenance several risks remain, as these could not be eliminated, and must be neutralised by adopting specific measures and precautions.

Do not carry out any checking, cleaning, repair or maintenance operations on moving parts. Workers must be informed of this prohibition by means of clearly visible signs.

To guarantee appliance efficiency and correct operation, periodical maintenance must be carried out according to the instructions given in this manual.

Make sure to periodically check correct operation of all the safety devices and the insulation of electrical cables, which must be replaced if damaged.

D.6 Reasonably foreseeable improper use

Improper use is any use different from that specified in this manual. During appliance operation, other types of work or activities deemed improper and that in general can involve risks for the safety of operators and damage to the appliance are not allowed. Reasonably foreseeable improper use includes:

- lack of appliance maintenance, cleaning and periodical checks;
- structural changes or modifications to the operating logic;
- tampering with the guards or safety devices;
- failure to use personal protection equipment by operators, specialised personnel and maintenance personnel;
- failure to use suitable accessories (e.g. use of unsuitable equipment or ladders);
- keeping combustible or flammable materials, or in any case materials not compatible with or pertinent to the work, near the appliance;
- wrong appliance installation;
- placing in the appliance any objects or things not compatible with its use, or that can damage the appliance, cause injury or pollute the environment;
- climbing on the appliance;
- non-compliance with the requirements for correct appliance use;
- other actions that give rise to risks not eliminable by the Manufacturer.

D.7 End of use

When the appliance is no longer to be used, make it unusable by removing the mains power supply wiring.

D.8 Residual risks

The appliance has several risks that were not completely eliminated from a design standpoint or with the installation of adequate protection devices. Nevertheless, through this manual the Manufacturer has taken steps to inform operators of such risks, carefully indicating the personal protection equipment to be used by them. In order to reduce the risks, provide for sufficient spaces while installing the unit. To preserve these conditions, the areas around the appliance must always be:

- kept free of obstacles (e.g. ladders, tools, containers, boxes, etc.);
- clean and dry;
- well lit.

For the Customer's complete information, the residual risks remaining on the appliance are indicated below: such situations are deemed improper and therefore strictly forbidden.

Residual risk	Description of hazardous situation
Slipping or falling	The operator can slip due to water or dirt on the floor
Burns/abrasions (e.g. heating elements, cold pan, cooling circuit plates and pipes)	The operator deliberately or unintentionally touches some components inside the appliance without using protective gloves.
Stab wounds	The operator deliberately or unintentionally touches some components with sharp edges during the appliance cleaning without using protective gloves.
Burns	The operator deliberately or unintentionally touches some components inside the appliance or dishes at the outfeed without using gloves or without allowing them to cool.
Shearing of upper limbs	The operator violently closes the front panels.
Electrocution	Contact with live parts during maintenance operations carried out with the electrical panel powered
Falling from above	The operator intervenes on the appliance using unsuitable systems to access the upper part (e.g. rung ladders, or climbs on it)
Crushing or injury	The specialised personnel may not correctly fix the control panel when accessing the technical compartment. The panel could close suddenly.
Tipping of loads	When handling the appliance or the packing containing it, using unsuitable lifting systems or accessories or with the unbalanced load
Chemical	Contact with chemical substances (e.g. detergent, rinse aid, scale remover, etc.) without taking adequate safety precautions. Therefore always refer to the safety cards and labels on the products used.



IMPORTANT

In case of a significant anomaly (e.g. short circuits, wires coming out of the terminal block, motor breakdowns, worn electrical cable sheathing, etc.) the operator must immediately deactivate the appliance.

E GENERAL INFORMATION

E.1 Introduction

This manual contains information relevant to various appliances. The product images in this guide are only an example.

The drawings and diagrams given in the manual are not in scale. They supplement the written information with an outline, but are not intended to be a detailed representation of the appliance supplied.

The numerical values given on the appliance installation diagrams refer to measurements in millimeters and/or inches.



E.2 Definitions

Listed below are the definitions of the main terms used in the manual. It is advisable to read them carefully before use.

Operator	machine installation, adjustment, use, maintenance, cleaning, repair and transport personnel.
Manufacturer	Electrolux Professional SpA or any other service centre authorised by Electrolux Professional SpA.
Operator for normal machine use	an operator who has been informed and trained regarding the tasks and hazards involved in normal machine use.
Customer Care service or specialised technician	an operator instructed/trained by the Manufacturer and who, based on his professional and specific training, experience and knowledge of the accident-prevention regulations, is able to appraise the operations to be carried out on the machine and recognise and prevent any risks. His professionalism covers the mechanical, electrotechnical and electronics fields.
Danger	source of possible injury or harm to health.
Hazardous situation	any situation where an operator is exposed to one or more hazards.
Risk	a combination of probabilities and risks of injury or harm to health in a hazardous situation.
Protection devices	safety measures consisting of the use of specific technical means (guards and safety devices) for protecting operators against risks.
Guard	an element of a machine used in a specific way to provide protection by means of a physical barrier.
Safety device	a device (other than a guard) that eliminates or reduces the risk; it can be used alone or in combination with a guard.
Customer	the person who purchased the machine and/or who manages and uses it (e. g. company, entrepreneur, firm).
Emergency stop device	a group of components intended for the emergency stop function; the device is activated with a single action and prevents or reduces damage to persons/machines/property/animals.
Electrocution	an accidental discharge of electric current on a human body.

E.3 Machine and Manufacturer's identification data

A reproduction of the marking or dataplate on the machine is given below:

F.Mod.	_____	Comm. Model:	_____	2017
PNC	_____	Ser.Nr.	_____	
EL	_____	z	_____	Max _____ kW
Type ref.	_____	Nominal	_____	_____ kW
		Min	_____	_____ kW
  				
Electrolux Professional spa - Viale Treviso, 15 - 33170 Pordenone (Italy)				

The dataplate gives the product identification and technical data; listed below is the meaning of the various information given on it.

F.Mod.	factory description of product
Comm.Model	commercial description
PNC	production number code
Ser.No.	serial number
400V 3N~	power supply voltage
230V 3~ - 230V 1N~	electric convertibility (depending on the model)
Hz	power supply frequency
Max – kW	max. power
Nominal – kW	nominal power
IPX4	dust and water protection rating
CE	CE marking
Electrolux Professional SpA Viale Treviso 15 33170 Pordenone Italy	manufacturer

The dataplate is located on the right side panel of the equipment.

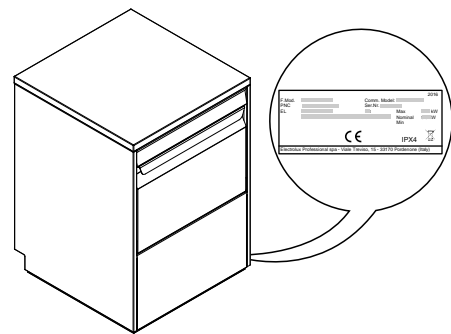

WARNING

Do not remove, tamper with or make the machine marking illegible.



IMPORTANT

When scraping the machine, the marking must be destroyed.



NOTE!

Refer to the data given on the machine marking for relations with the Manufacturer (e.g. when ordering spare parts, etc.).

E.4 How to identify the technical data

To identify the technical data, read the factory description of the product (F. Mod.) on the dataplate, identify the main machine data and consult *G TECHNICAL DATA* paragraph.

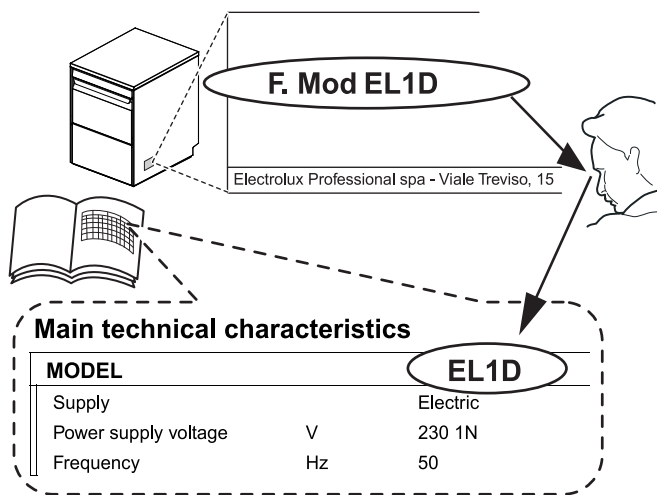

E.4.1 How to interpret the factory description

The factory description on the dataplate has the following meaning (some examples are given below):

(1)	(2)	(3)	(4)	(5)	(6)	(7)
E	L		I	3		
E	L	A	I	1	G	
E	L	A	I	3	W	P
E	UC			A060		
E	UC			A060	WS	

(1) Brand	E = Electrolux Professional, Z = Zanussi, V = Veetsan, N = To brand, C = Cater-Wash, D = Dräger, H = Harstra, X = KlumaierXtunner, ET5 = Ecolab.
(2) Machine type	L = Under counter UC = Under counter
(3) Rinsing system	A = Atmospheric Empty = Pressure
(4) Machine type	I = Double insulation Empty = Single insulation
(5 - 7) Options	1 = Single phase 3 = Three phases 4 = 240V (North America) 8 = 208V (North America) 6 = 60 Hz C = Cold rinse or cold water inlet D = Detergent pump installed P = Drain pump installed G = Detergent and drain pumps installed W = Water Softener installed A060 = Compliant with A ₀ 60 level according to EN 15883-1 Standard /DD = Drain pump installed WS = Water Softener, drain pump, detergent pump installed MS = Multi rack support OW = On Wheels NR = No rack CL = Cafe Line WL = Wine Line AG = AutoGrill MCD = Mc Donalds PR = Promotion code TL = Thermal Label compliant U = UK plug L = AISI316 Stainless steel boiler installed 5M = 400V 3~ 50 Hz Marine 6M = 440V 3~ 60 Hz Marine 35M = 230V 3~ 50 Hz Marine 36M = 230V 3~ 60 Hz Marine USPH5 = 400V 3~ 50 Hz Marine USPH6 = 440V 3~ 60 Hz Marine

E.5 Type reference

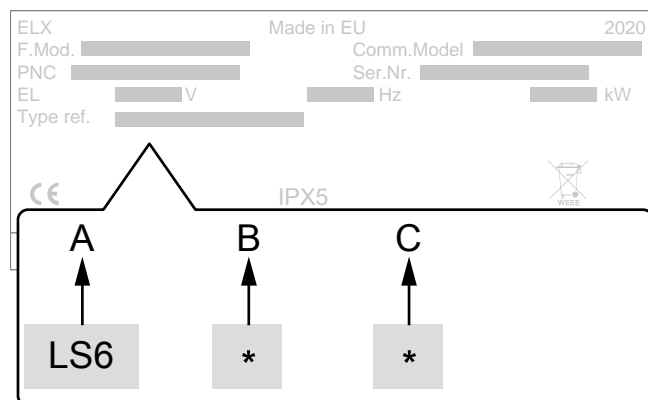

Legend

A	Type of appliance • Under counter dishwasher
B	Rinsing type • 0 = without rinse pump • 1 = with rinse pump
C	Water treatment • 0 = without water softener [WS] • 1 = with water softener [WS]

E.6 Responsibility

The Manufacturer declines any liability for damage and malfunctioning caused by:

- non-compliance with the instructions contained in this manual;
- repairs not carried out in a workmanlike fashion, and replacements with parts different from those specified in the spare parts catalogue (the fitting and use of non-original spare parts and accessories can negatively affect appliance operation and invalidates the original manufacturer warranty);
- operations carried out by non-specialised personnel;
- unauthorized modifications or operations;
- missing, lack or inadequate maintenance;
- improper appliance use;
- unforeseeable extraordinary events;
- use of the appliance by uninformed and / or untrained personnel;
- non-application of the current provisions in the country of use, concerning safety, hygiene and health in the workplace.

The Manufacturer declines any liability for damage caused by arbitrary modifications and conversions carried out by the user or the Customer.

The employer, workplace manager or service technician are responsible for identifying and choosing adequate and suitable personal protection equipment to be worn by operators, in compliance with regulations in force in the country of use.

The Manufacturer declines any liability for inaccuracies contained in the manual, if due to printing or translation errors.

Any supplements to the installation, use and maintenance manual the Customer receives from the Manufacturer will form an integral part of the manual and therefore must be kept together with it.

E.7 Copyright

This manual is intended solely for consultation by the operator and can only be given to third parties with the permission of Electrolux Professional SpA company.

E.8 Keeping the manual

The manual must be carefully kept for the entire life of the appliance, until scrapping. The manual must stay with the

appliance in case of transfer, sale, hire, granting of use or leasing.

- operators for normal machine use
- specialised technicians - Customer Care service (see service manual).

E.9 Recipients of the manual

This manual is intended for:

- the employer of machine users and the workplace manager

F NORMAL USE

F.1 Correct use

Our machines are designed and optimized in order to obtain high performance and efficiency.

This equipment must only be used for its expressly designed purpose, i.e. washing dishes with water and specific detergents. Any other use is to be deemed improper.

F.2 Characteristics of personnel enabled to operate on the appliance

The Customer must make sure the personnel for normal appliance use are adequately trained and skilled in their duties.

The operator must:

- read and understand the manual;
- receive adequate training and instruction for their duties in order to operate safely;
- receive specific training for correct appliance use.



IMPORTANT

The Customer must make sure his personnel have understood the instructions received and in particular those regarding work hygiene and safety in use of the appliance.

F.3 Basic requirements for appliance use

- Knowledge of the technology and specific experience in operating the appliance.
- Adequate general basic education and technical knowledge for reading and understanding the contents of the manual, including correct interpretation of the drawings, signs and pictograms.
- Sufficient technical knowledge for safely performing his duties as specified in the manual.
- Knowledge of the regulations on work hygiene and safety.

G TECHNICAL DATA

G.1 Main technical characteristics for single phase appliances

Model		ELAI1G CLA1G	ELAI1GCL	ELAI1WG NLA1WG	ELAI1G8 VLA1G8 DLAI1G8...	ELAI1G4 VLA1G4	ELI1G36M
Supply voltage:		230V 1N~	230V 1N~	230V 1N~	208V 1~ 33 amp	240V 1~ 29 amp	230V 1N~
Convertible to:		400V 3N~ 230V 3~	400V 3N~ 230V 3~	400V 3N~ 230V 3~	208V 3~ 20 amp	240V 3~ 18 amp	400V 3N~ 230V 3~
Minimum Supply - Circuit Ampacity		-	-	-	34 amp	34 amp	-
Frequency	Hz	50	50	50	60	50	60
Max. power	kW	5.35 [7.35] ¹	6.85 [8.85] ¹	5.35 [7.35] ¹	6.85	6.85	6.85 [8.85] ¹
Boiler [booster] heating elements	kW	4.5	6	4.5	6.0	6.0	6
Tank heating elements	kW	2.0	2.0	2.0	2.2	2.2	2.0
Water supply pressure	bar [kPa] (psi)	0.5 - 7 [50 - 700]	0.5 - 7 [50 - 700]	0.5 - 7 [50 - 700]	0.5 - 7 [50 - 700] (7.25 - 101)	0.5 - 7 [50 - 700] (7.25 - 101)	2 - 3 [200 - 300]
Water supply temperature	°C [°F]	50 [122]	50 [122]	50 [122]	10 - 50 [50 - 122]	10 - 50 [50 - 122]	50 [122]
Water supply hardness	°f/°d/°e [ppm]	14/8/10 max	14/8/10 max	48/27/33.7 max	14/8/10 max [140]	14/8/10 max [140]	14/8/10 max
Electric conductivity of water	µS/cm [µS/in]	< 400	< 400	< 400	< 400 [< 1016]	< 400 [< 1016]	< 400
Concentration of chlorides in water	ppm	< 20	< 20	< 20	< 20	< 20	< 20
Rinse cycle water consumption	l [gal]	2.5	2.5	2.5	2.5 [0.66]	2.5 [0.66]	2.5
Boiler capacity	l [gal]	12	12	12	12 [3]	12 [3]	12

Model		ELAI1G CLAI1G	ELAI1GCL	ELAI1WG NLAI1WG	ELAI1G8 VLAI1G8 DLAI1G8...	ELAI1G4 VLAI1G4	ELI1G36M
Tank capacity	l	23	23	23	23 [6]	23 [6]	23
Standard cycle time with water supply at 50°C [122°F]. ²	sec.	90 - 120 - 240	90 - 120 - 240	90 - 120 - 240	120 - 180 - 240 [120 - 240] ³	120 - 180 - 240 [120 - 240] ⁴	90 - 120 - 240
Legal noise level Leq ⁵	dB(A)	LpA: 61dB - KpA: 1.5dB					
Protection rating		IPX4					
Type of power supply cable		H07RN-F SOOW					
		 IMPORTANT The power supply cable must be in compliance with the regulations and provisions in force in the country of use					

1. If activated by software, coincidence of tank and boiler heating elements.
2. Standard cycle time may vary should the inlet water temperature and/or the boiler heating elements be different from that indicated above.
3. Only for model VLAI1G8
4. Only for model VLAI1G4
5. The noise emission values have been obtained according to EN ISO 11204.

G.2 Main technical characteristics for three phases appliances

Model		ELAI3... ZLAI3... NLAI3... VLAI3... DLAI3... HLAI3... XLAI3... DW6-38	ELI3 ZLI3	ELI3CG ZLI3CD	ELAI3WP ZLAI3WP ZLAI3WG	ELI3G5M ELI3G35M	ELI3G6M ELAI3- GUSPH6 ELAI3- GUSPH5
Supply voltage:		400V 3N~	400V 3N~	380 - 415V 3N~ [400V 3N~] ¹	400V 3N~	400V 3N~ [230V 3~] ²	440V 3~ [400V 3~] ³
Convertible to:		230V 3~ 230V 1N~	230V 3~ 230V 1N~	220 - 240V 3~ 220 - 240V 1N~	230V 3~ 230V 1N~	[230V 1N~] ² [400V 3N~] ²	[230V 1N~] ³ [230V 3~] ³
Frequency	Hz	50 [60] ⁴	50	50	50	50	60 [50] ³
Max. power	kW	5.35 [7.35] ⁵	5.35 [7.35] ⁵	6.85 [8.85] ⁵ 6.85 ¹	5.35 [7.35] ⁵	8.85 [6.85] ⁵	8.85 [6.85] ⁵
Boiler heating elements	kW	4.5 [6] ⁶	4.5	6	4.5	6	6
Tank heating elements	kW	2.0	2.0	2.0	2.0	2.0	2.0
Water supply pressure	bar [kPa]	0.5 [50] 7 [700]	2 [200] 3 [300]	2 [200] 3 [300]	0.5 [50] 7 [700]	2 [200] 3 [300]	2 [200] - 3 [300] 0.5 [50] - 7 [700] ⁷
Water supply temperature	°C [°F]	50 [122] 10 - 50 [50 - 122] ⁶	50 [122]	10 - 50 [50 - 122] 50 - [122] ¹	50 [122]	50 [122]	50 [122]
Water supply hardness	°f/°d/°e	14/8/10 max	14/8/10 max	14/8/10 max	48/27/33.7 max	14/8/10 max	14/8/10 max
Electric conductivity of water	µS/cm	< 400	< 400	< 400	< 400	< 400	< 400
Concentration of chlorides in water	ppm	< 20	< 20	< 20	< 20	< 20	< 20

Model		ELAI3... ZLAI3... NLAI3... VLAI3... DLAI3... HLAI3... XLAI3... DW6-38	ELI3 ZLI3	ELI3CG ZLI3CD	ELAI3WP ZLAI3WP ZLAI3WG	ELI3G5M ELI3G35M	ELI3G6M ELAI3- GUSPH6 ELAI3- GUSPH5
Rinse cycle water consumption	l	2.5	2.5	2.5	2.5	2.5	2.5
Boiler capacity	l	12	12	12	12	12	12
Tank capacity	l	23	23	23	23	23	23
Standard cycle time with water supply at 50°C [122°F]. ⁸	sec.	90 - 120 - 240	90 - 120 - 240	90 - 120 - 240	90 - 120 - 240	90 - 120 - 240	90 - 120 - 240
		[90 - 180] ⁹					[120 - 180 - 240] ⁷
Legal noise level Leq ¹⁰	dB(A)	LpA: 61dB - KpA: 1.5dB					
Protection rating	IPX4						
Type of power supply cable	H07RN-F						
		 IMPORTANT The power supply cable must be in compliance with the regulations and provisions in force in the country of use					

1. Only for model ZLI3CD
2. Only for model ELI3G35M
3. Only for model ELAI3GUSPH5
4. Only for model ELAI3P6
5. If activated by software, coincidence of tank and boiler heating elements.
6. Only for model NLAI3CG
7. Only for models ELAI3GUSPH5 and ELAI3GUSPH6
8. Standard cycle time may vary should the inlet water temperature and/or the boiler heating elements be different from that indicated above.
9. Only for model VLAI3G
10. The noise emission values have been obtained according to EN ISO 11204.

Model		ELAI3GTL	ELAI3GCL	ELAI3GWL	EUCA060 VUCA060 ZUCA060 ELAI3PML ELAI3WGML	ET5AI	ET5AIP
Supply voltage:		400V 3N~	400V 3N~	400V 3N~	400V 3N~	400V 3N~	400V 3N~
Convertible to:		230V 3~ 230V 1N~	230V 3~ 230V 1N~	230V 3~ 230V 1N~	230V 3~ 230V 1N~	230V 3~ 230V 1N~	230V 3~ 230V 1N~
Frequency	Hz	50	50	50	50	50	50
Max. power	kW	5.35 [7.35] ¹	9.85 [11.85]	6.85 [8.85] ¹	6.85 [8.85] ¹	8.85	6.85
Boiler heating elements	kW	4.5	9	6	6	6	6
Tank heating elements	kW	2.0	2.0	2.0	2.0	2.0	2.0
Water supply pressure	bar [kPa]	0.5 [50] 7 [700]	0.5 [50] 7 [700]	0.5 [50] 7 [700]	0.5 [50] 7 [700]	2 [200] 3 [300]	0.5 [50] 7 [700]
Water supply temperature	°C [°F]	50 [122]	50 [122]	50 [122]	50 [122]	10 [50]	10 [50]
Water supply hardness	°f/°d/°e	14/8/10 max	14/8/10 max	14/8/10 max	14/8/10 max [48/27/33.7 max] ²	14/8/10 max	14/8/10 max
Electric conductivity of water	µS/cm	< 400	< 400	< 400	< 400	< 400	< 400
Concentration of chlorides in water	ppm	< 20	< 20	< 20	< 20	< 20	< 20

Model		ELAI3GTL	ELAI3GCL	ELAI3GWL	EUCA060 VUCA060 ZUCA060 ELAI3PML ELAI3WGML	ET5AI	ET5AIP
Hot rinse cycle water consumption	l	3 (for wash cycle 1) 3.5 (for wash cycle 2) 4 (for wash cycle 3)	2.5	3.8	3 (for wash cycle 1 and 2) 4 (for wash cycle 3) ³	3	3
Cold rinse cycle water consumption	l	1.8	-	-	-	-	-
Boiler capacity	l	12	12	12	12	12	12
Tank capacity	l	23	23	23	23	23	23
Standard cycle time with water supply at 50°C [122°F]. ⁴	sec.	90 - 120 - 240	90 - 120 - 240	90 - 113 - 173	90 - 120 - 240 ³ [90 - 240] ⁵	90 - 120 - 120	90 - 120 - 120
Legal noise level Leq ⁶	dB(A)	LpA: 61dB - KpA: 1.5dB					
Protection rating	IPX4						
Power supply cable	H07RN-F						
		 IMPORTANT The power supply cable must be in compliance with the regulations and provisions in force in the country of use					

1. If activated by software, coincidence of tank and boiler heating elements.
2. Only for model ELAI3WGML
3. Disinfection cycle.
4. Standard cycle time may vary should the inlet water temperature and/or the boiler heating elements be different from that indicated above.
5. Only for model VUCA060
6. The noise emission values have been obtained according to EN ISO 11204.

H PRODUCT DESCRIPTION

H.1 General description

The appliance is suitable for washing glasses, cups, cutlery. Under no circumstances it can be used for other applications or ways not provided for in this manual.

This equipment has been created in order to ensure a better work environment and cost efficiency.

These appliances are used in restaurants, cafeterias, cooking centers and large institutions. The special dish racks, that can be equipped with various inserts, offer practical and easy use for obtaining excellent washing results.

The electronic system enables complete supervision of the washing process. The control panel also has a display that shows the operating parameters and signals any faults.

H.2 Machine overview

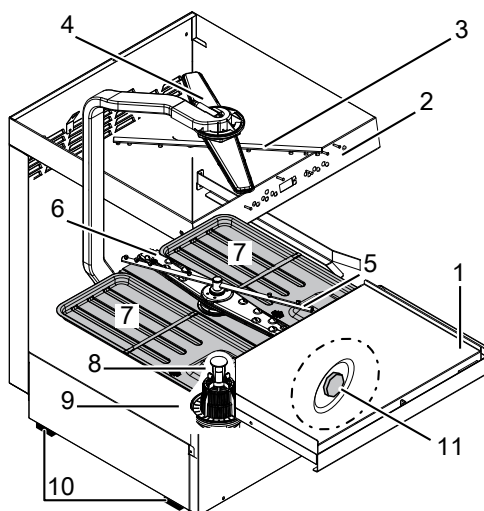

1	Door
2	Control panel
3	Upper rinse arm
4	Upper washer arm
5	Lower washer arm
6	Lower rinse arm
7	Flat filters
8	Overflow
9	Wash tank filter
10	Adjustable feet
11	Salt container (depending on the model)

I CONTROL PANEL DESCRIPTION

I.1 Control panel description

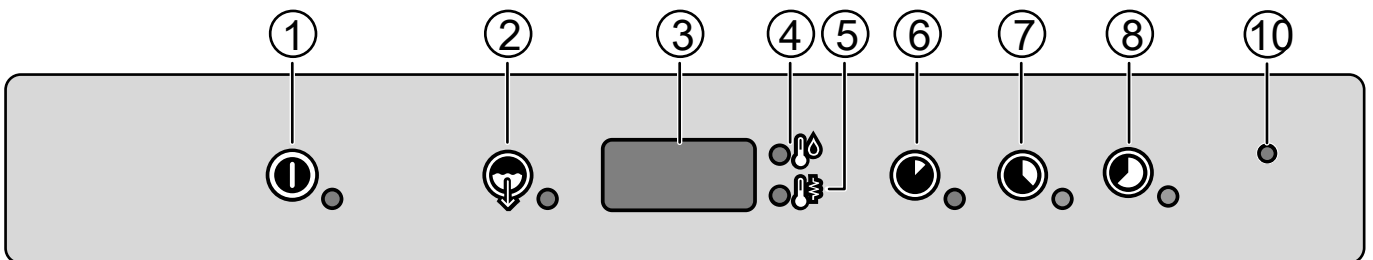
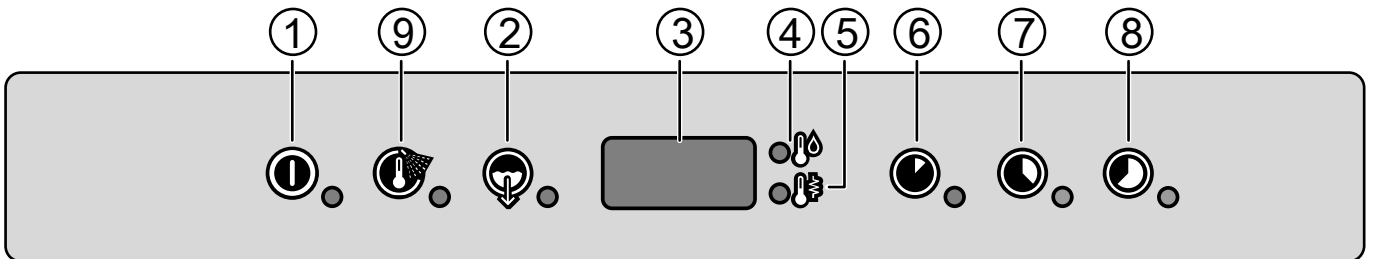
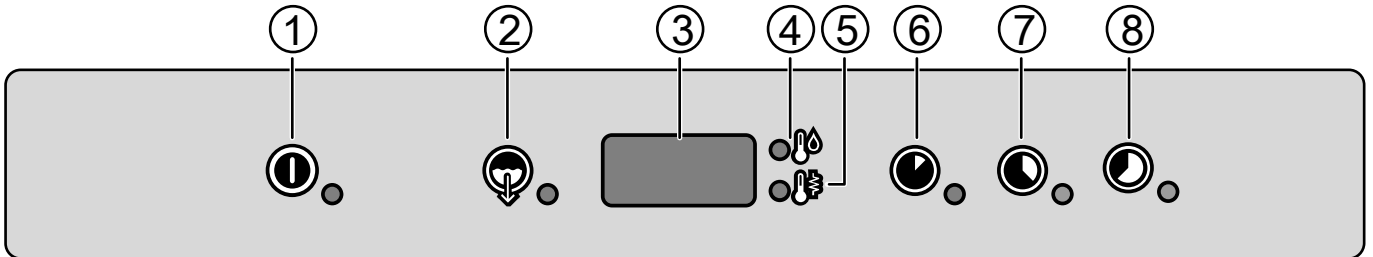
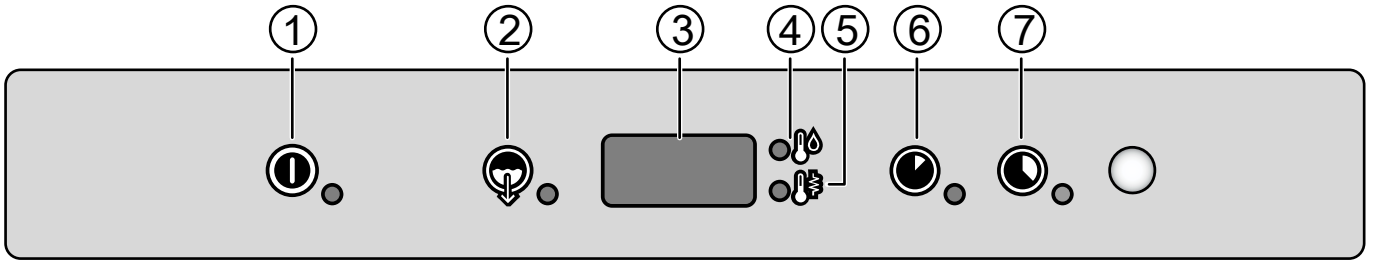

1	On/Off
2	Drain/self-cleaning cycle
3	Display
4	Tank temperature indicator
5	Boiler temperature indicator
6	Wash cycle 1
7	Wash cycle 2
8	Wash cycle 3
9	Cold rinse cycle
10	Active/Wash Safe Control indicator



NOTE!

The temperature shown on the display refers to the boiler if the indicator "5" is lit up or to the tank, if the indicator "4" is lit up. The tank temperature is displayed during the wash phase and the boiler temperature during the rinse phase.

I.2 Basic Controls

Described below are all the single buttons and functions available in the various control panel models listed above. Some functions are common to all models of the range, whereas others are available only on some versions.

On/Off

This button indicates equipment status: on or off. When the equipment is on, the button indicator is lit up.

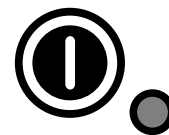

Cold rinse cycle

This button starts a cold rinse cycle at the end of the selected wash cycle. When the cycle is selected, the button indicator is lit up. This cycle remains active for all the wash cycles. Particularly suitable for rinsing glasses.



Drain / self-cleaning cycle

This button starts a drain/self-cleaning cycle. When the cycle is selected, the button indicator is lit up.



Wash cycle 1

This button starts **Wash cycle 1**. When the cycle is selected, the button indicator is lit up. This cycle is recommended for washing not very dirty dishes.



Wash cycle 2

This button starts **Wash cycle 2**. When the cycle is selected, the button indicator is lit up. This cycle is recommended for washing normally dirty dishes.



NOTE!

If the dishwasher has only 2 wash cycles, this cycle is recommended for washing very dirty dishes.



Wash cycle 3

This button starts **Wash cycle 3**. When the cycle is selected, the button indicator is lit up. This cycle is recommended for washing very dirty dishes.



Active/Wash Safe Control indicator



In the **Active/Wash Safe Control** models a special device checks the temperature of the rinse phase. The **GUARANTEED RINSE SYSTEM [GRS]** is an automatic rinse time/temperature control system.

The **GUARANTEED RINSE SYSTEM** is active:

- during the wash cycle and the indicator light is OFF;
- during the rinse cycle and the indicator light comes on and is GREEN;
- at the end of the rinse cycle. The indicator light is GREEN if the rinse temperature and time have been carried out as per the programme, otherwise the indicator light is RED;
- upon opening the door, the indicator light GOES OUT.



NOTE!

If the indicator light is RED, wait for a couple of minutes and then repeat the wash cycle.

J OPERATION

J.1 Starting



NOTE!

Carry out a couple of cycles without dishes to flush out any industrial grease which has remained in the tank and piping.

- Open the water supply tap.
- Switch on at the mains.
- Open the door and check that all the components are in their correct position.
- Close the door and press On/Off button.

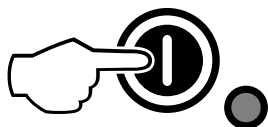

- The indicator light of On/Off button comes on, indicating that the dishwasher is powered and that water is being introduced and heated. The word "FILL" is shown on the display during the entire filling and heating stage:



NOTE!

For atmospheric versions only: this dishwasher does the first tank filling through several consecutive hot rinse cycles, while the display shows the message "FILL" (flowing). This system let save up to 30% of time than traditional models.

- If the door is opened during this stage the message "CLOSE" will appear on the display:



- The filling and heating stage has finished when the display shows the tank temperature:

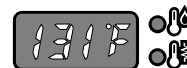

NOTE!

For "Thermal Label" compliant models the display shows 75°C [167°F].

For "A060" compliant models the display shows 77°C [170°F].

- To display the boiler temperature during heating of the tank, open the door and press the **Wash cycle 1** button.

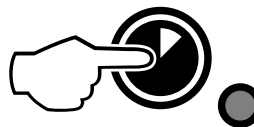

J.2 Loading dishes on racks

The appliance is suitable for washing dishes, glasses, cups, cutlery, containers and receptacles in plastic and/or steel used for preparing, cooking and serving; as well as a wide variety of ceramic and/or metal cooking utensils. However it is advisable not to wash decorated dishes or place silverware in contact with other metals.



IMPORTANT

The appliance does not remove burnt food deposits from dishes. Dishes with burnt-on food deposits should be cleaned mechanically/chemically before putting them in the dishwasher. Before inserting the racks in the machine, clear the dishes of any food residuals and rinse them with cold or warm water, at a max. temperature of 35°C [95°F], using a manual prewash spray.

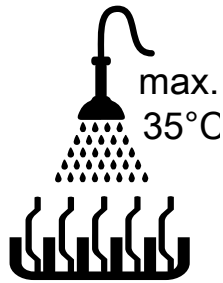
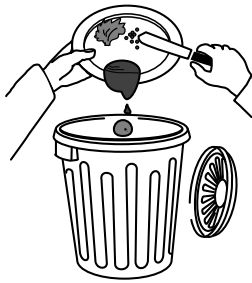

CAUTION

Failure to remove the residuals of detergent possibly used for manual prewash can cause malfunctioning of the dishwasher and compromise washing results.



IMPORTANT

This machine must only be used for washing dishes, containers, etc. (see above) do not use it to wash animals or food (e.g., fruit, vegetables, meat or fish).

J.3 Type of racks and loading



NOTE!

Not all these racks are available for each model.

- **YELLOW** rack: for 18 plates with maximum diameter of 240 mm.

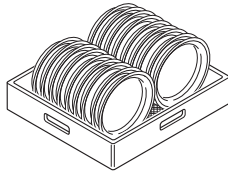

- **GREEN** rack: for 12 bowls with maximum diameter of 240 mm.

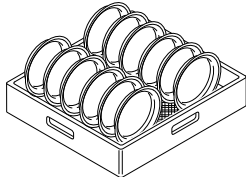

- **BLUE** rack for glasses: the glasses should be placed upside down.

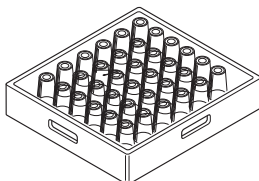

- **YELLOW** container for cutlery: insert items, with the handles pointing downwards, in each container.

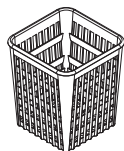

- **Half size basket - universal** (500 x 250 mm)

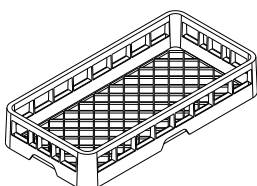

- **Half-size basket for plates** (500 x 250 mm)

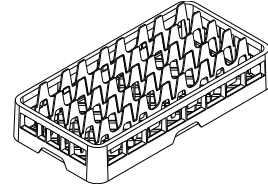

- **Half size basket for glasses** (500 x 250 mm)

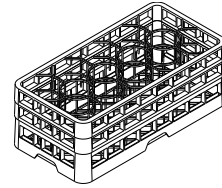

Available as accessories: dividers for glasses and rack for dishes with maximum diameter of 320 mm.



IMPORTANT

If only one type of dish rack is to be used, it is advisable to choose the **GREEN** rack.

J.4 Operation



IMPORTANT

- To guarantee sanitization of the dishes, wash at least 3 empty racks at lowest speed. This allows all the machine to reach the working temperature. Repeat the procedure if the machine is stopped or the door is opened for a long time.
- During normal daily operations, make sure to change the water in the tank at least twice a day.

The filling and heating stage has finished when the display shows the tank temperature. The appliance is then ready for use.

- Open the door.
- Only for model without detergent pump, pour the required amount of detergent into the tank.
- Insert the rack containing the dirty dishes.
- Close the door and select the suitable wash cycle; the corresponding indicator light comes on and the wash cycle starts:



NOTE!

For the "A060" models, a closing device locks the door for the entire duration of the wash cycle. By pressing the button of the selected cycle, the cycle is stopped and the door is released.

- **Cycle I**

For lightly soiled dishes: press button **Wash cycle 1** (see table of times).

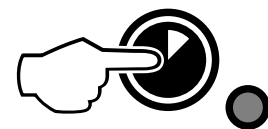

- **Cycle II** (recommended)

For very dirty dishes: press button **Wash cycle 2** (see table of times).

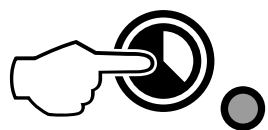

- **Cycle III**

For very dirty dishes: press button **Wash cycle 3** (see table of times).

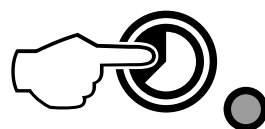

- To stop the wash cycle, just press the selected cycle button or open the door.
- To continue the wash cycle, press the cycle button again or close the door. The cycle starts again from where it was stopped.
- At the end of the wash, the dishwasher emits a series of beeps and the message "END" blinks on the display:



IMPORTANT

At the end of the rinse phase for wash cycle 2 (VUCA060 model) or cycle 3 (EUCA060, EUCA060/DD, EUCA060WS and ZUCA060 models), the dishwasher carries out a pause stage of 1 minute. Plus the door lock hinders door open to avoid interruption of the wash cycle by opening the door. This procedure complies with requirement to meet "A060" level according to EN 15883-1 Standard, also improving the drying result on the wares.

- Open the door and remove the rack containing the clean dishes.



CAUTION

The use of "foaming/nonspecific" detergents or in any case detergents used in different ways from that prescribed by the manufacturer, can cause damage to the dishwasher and compromise the washing results.

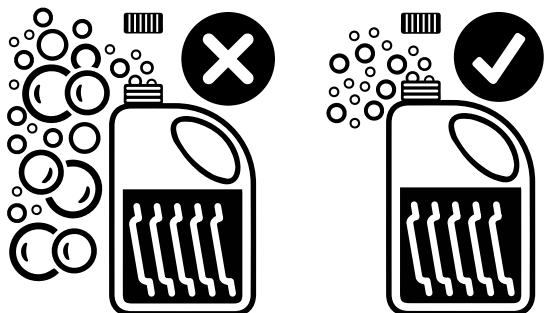

NOTE!

To obtain excellence washing performance, use detergent, rinse aid and descaling agent suggested by Electrolux Professional. In the Electrolux Professional web site, open the "Accessories and Consumables" web page and navigate into the dishwashing equipment tab to order most suitable detergents and accessories.

J.5 Wash cycles

The wash cycle includes one wash with hot water and detergent (min 55°C [131°F]) and one rinse with hot water and rinse-aid (min 82 °C [180°F]).



NOTE!

- The "Thermal Label" model is designed to guarantee thermal sanitization with a temperature of 71°C [160°F] reached at tableware surface when operating continuously, loaded at 70% of nominal productivity (i.e. racks slightly spaced). Since the performance depends on the load and environmental and water feed condition, before starting washing operations it is suggested to test (using 71°C [160°F] thermal labels) a full-load rack to confirm the effectiveness of parameters; in case of test failure, a lower speed washing cycle must be set and the test repeated.
- In the "Hygiene & Clean" model, the wash cycle includes a wash with hot water and detergent at a temperature of at least 77°C [170°F] and a rinse with hot water and rinse aid (min. 90°C [194°F]).

Table of times: standard cycle time with supply water at 50°C [122°F]

Model			
ELAI1G - CLAI1G - ELAI1GCL - ELAI1WG - NLAI1WG - ELI1G36M ELAI3... - ZLAI3... - NLAI3... - VLAI3... - DLAI3... - HLAI3... - XLAI3... - ELI3 - ZLI3 - ELI3CG - ZLI3CD - ELAI3WP - ZLAI3WP - ZLAI3WG - ELI3G5M - ELI3G35M - ELI3G6M - DW6-38 ELAI3GTL - ELAI3GCL	90 sec	120 sec	240
ELAI1G8 - DLAI1G8NR - ELAI1G4	120 sec	180 sec	240 sec
VLAI1G8 - VLAI1G4	120 sec	240 sec	-
VLAI3G	90 sec	180 sec	-
ELAI3GUSPH5 - ELAI3GUSPH6	120 sec	180 sec	240 sec
ELAI3GWL	90 sec	113 sec	173 sec
EUCA060 - ZUCA060 ELAI3PML - ELAI3WGML	90 sec ²	120 sec ²	240 sec ³
VUCA060	90 sec ²	240 sec ³	-

1. Wash cycle compliant with A060 standard is guaranteed using supplied racks.

2. Compliant with DIN10512 Standard.

3. Disinfection cycle. Compliant with A060 level according to EN 15883-1 Standard.

Table of times: standard cycle time with supply water at 10°C [50°F]

Model			
ET5AI - ET5AIP	90 sec	120 sec	120 sec



NOTE!

Standard cycle time may vary should the inlet water temperature and/or the boiler heating elements be different from that indicated above.

A device lengthens the cycle time if the water in the boiler has not reached the minimum temperature for correct rinsing.

The cycle times and the temperature may be personalised (e.g. increase of the rinse time and temperature). The cycle times should only be set by a specialised personnel.

J.6 Continuous water softener



IMPORTANT

Unlike conventional water softeners, this continuous softener does not require machine stops for regenerating the resins.

By means of special resins, this device removes the calcareous substances from the feed water, supplying decalcified water for washing. For the continuous softener to work properly the resins must be regenerated periodically, with frequency depending on the hardness of the water and the number of wash cycles carried out.

Degrees of water hardness

Level	Cycles	Degrees		
		°fH	°dH	°cH
1	soft	0 – 5.5	0 – 3	0 – 4
2	medium	7 – 14	4 – 8	5 – 10
3	hard	16 – 26.5	9 – 15	11 – 18.6
4	very hard	> 27	> 16	> 19

Salt container refill frequency according the water inlet hardness

Water hardness			Cycles	Days	Using cycle 2 for 30 cycles/day, the salt container must be filled approximately every ¹ :
°f	°d	°e			
15	8,4	10,5	1168	39	The salt container must be filled approximately every ¹ :
20	11,2	14	837	28	
25	14	17,5	589	19	
30	16,8	21,1	506	17	
35	19,6	24,6	423	14	
40	22,4	28,1	341	11	



NOTE!

The factory setting of max. outlet water hardness is 10 °f/ 5.6 °d/ 7 °e. During installation of the appliance, the installation technician should nonetheless check the correct setting of this value.

1. Considering a rinse time according to the factory settings.

J.6.1 Salt container



CAUTION

Only use coarse salt with a purity level of 99.8% NaCl. The use of salt with a lower purity level can cause clogging of the salt container filter and malfunctioning of the water softener.



CAUTION

Do not introduce any other chemical substances such as detergent, rinse aid or descaling agent, since these would inevitably damage the appliance. Such damage invalidates any warranty and relieves the manufacturer of all liability.

The water can only be softened if there is salt in the special container. The salt container must be filled when the dishwasher is started the first time and whenever the message **SAL End** appears on the display and an audible alarm sounds. Wash cycles can be started just the same, even if the display signals no salt; in which case the water used for washing is not softened.



IMPORTANT

Open the salt container only when the message **SAL End** is displayed. Opening the cap when the message **SAL End** is not displayed can cause spillage of the saline solution and compromise correct machine operation.

J.6.2 Fill the salt container

- Switch off the dishwasher by pressing On/Off button.

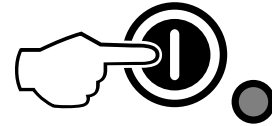

- Unscrew cap "A" (Figure below) of the salt container, turning it counterclockwise.

The salt container always has water in it, therefore it is normal if water comes out during filling.

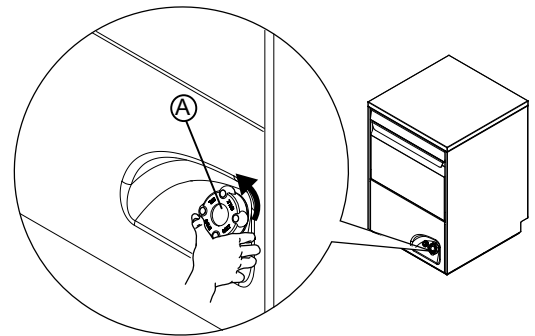

- Pour approx. 1.5 kg of coarse salt [NaCl] in container "A" (an amount sufficient to fill the salt container up to the rim) using the special funnel supplied (see figure below).

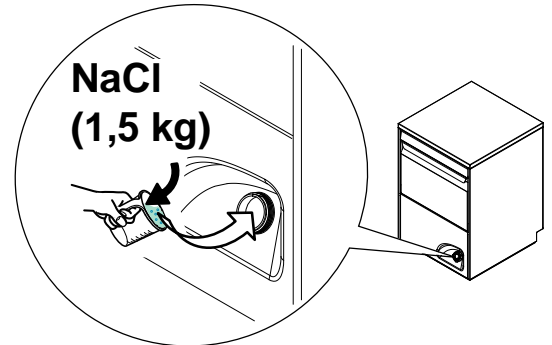

- Remove any traces of salt from the filling hole, the container thread and the closing cap seal.
- Refit the cap of container "A", turning it clockwise and making sure it is tight.



NOTE!

The message **SAL End** may appear for several wash cycles even after topping-up the salt, as the salt must circulate in the entire system. Correct operation of the dishwasher is not, however, affected.

K DAILY CLEANING



WARNING

Refer to "Safety Information".

K.1 Appliance cleaning

Cleaning must be carried out after every day of use. Use hot water, a neutral detergent/cleaner if necessary, and a soft

brush or sponge. If another type of detergent is used, carefully follow the producer's instructions and observe the safety rules given in the information sheets provided with the product or substance.

In order to reduce the environmental impact of pollutants it is advisable to clean the appliance (externally and, where necessary, internally) with products that are more than 90% biodegradable.



CAUTION

Do not use steel wool or similar material to clean stainless-steel surfaces. Do not use detergents containing chlorine.



WARNING

When using chemicals, comply with the safety notes and dosage recommendations printed on the packaging. Refer to the chapter *A.3 Personal protection equipment* for handling chemical products.



K.2 End of service

The appliance is designed to carry out an automatic cleaning cycle to help flush out any residues and to guarantee greater health and hygiene:

- Open the door and take out the rack containing the clean dishes.
- Remove the flat filters "C".

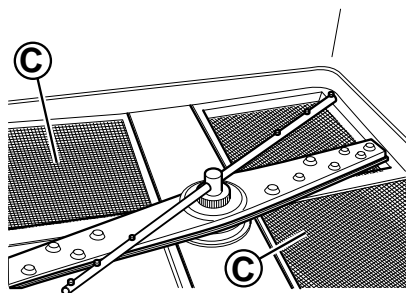

- Remove the overflow "A".

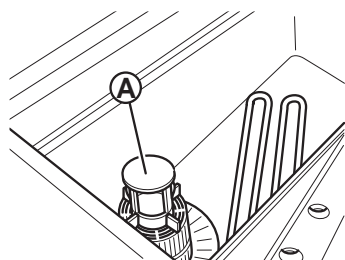

- Close the door. Select the drain cycle by pressing button Drain/Self cleaning cycle.

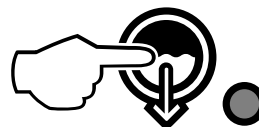

- The message "CLE" will be displayed throughout the drain cycle:



- After a few minutes, 3 beeps indicate the end of the cleaning cycle and the message "END" blinks on the display:



- Switch off the dishwasher by pressing ON/OFF button.

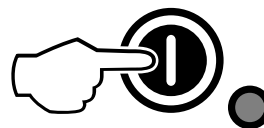

- Switch off at the mains.
- Close the water supply tap.
- Remove the top and bottom wash and rinse arms "F" and "I", unscrewing the ring nut "H".

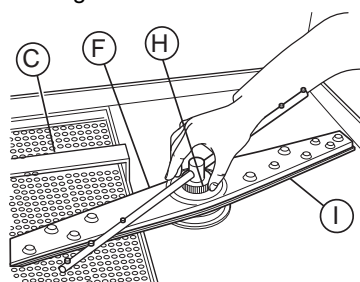

- Carefully clean the washing and rinse jets and clean everything with hot water and neutral detergent/deterasive, if necessary using a soft brush or sponge. Do not use sharp implements to clean the nozzle holes, which could otherwise be damaged.
- Clean the flat filters "C" under a water spray.
- Remove the tank filter "Z" and clean away any remained food in order to avoid blocking the draining system.

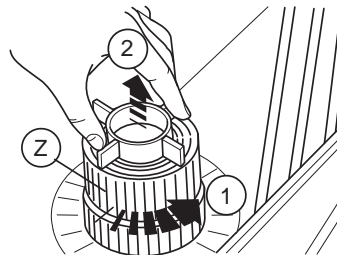

- Upon completion of cleaning operations, replace the parts removed previously:
 - tank filter "Z" and the overflow "A";
 - the flat filters "C";
 - top and bottom wash and rinse arms "F" and "I", screwing the ring nut "H".

L MAINTENANCE

L.1 Maintenance intervals

The inspection and maintenance intervals depend on the actual machine operating conditions and ambient conditions (presence of dust, damp, etc.), therefore precise time intervals cannot be given. In any case, careful and periodical machine maintenance is advisable in order to minimise service interruptions.

L.1.1 Preventive Maintenance

Preventive Maintenance reduces downtime and maximizes machines efficiency.

Customer Care Service can provide advice on the best maintenance plan to be purchased based on the intensity of use and the age of the equipment.

It is advisable to stipulate a preventive and scheduled maintenance contract with the Customer Care Service.

L.2 Maintenance frequency

To ensure constant appliance efficiency, it is advisable to carry out the checks with the frequency given in the following table:

Maintenance, inspections, checks and cleaning	Fre-quency	Respon-sability
Ordinary cleaning • general cleaning of appliance and surrounding area	Daily	Operator
Ordinary cleaning • Every month descale the wash and rinse jets with vinegar.	Monthly	Operator
Ordinary cleaning • Every month descale the wash and rinse jets with scale remover.	Monthly	Service
Mechanical protection devices • check their condition and for any deformation, loosening or removed parts	Monthly	Service
Control • check the mechanical part, for cracks or deformation, tightening of screws: check the readability and condition of words, stickers and symbols and restore if necessary	Yearly	Service
Appliance structure • Descale the boiler, inside surfaces of the tank and the appliance piping.	Yearly	Service
Appliance structure • The internal hose of the rinse-aid and detergent peristaltic dispenser should undergo periodic maintenance.	Yearly	Service
Appliance structure • If present, clean the finned coil of the energy saving device.	Yearly	Service
Appliance structure • tightening of main bolts (screws, fixing systems, etc.) of appliance	Yearly	Service
Safety signs • check the readability and condition of safety signs	Yearly	Service

Maintenance, inspections, checks and cleaning	Fre-quency	Respon-sability
Electrical control panel • check the electrical components installed inside the electrical control panel. Check the wiring between the electrical panel and appliance parts.	Yearly	Service
Electrical connection cable and plug • check the connection cable (replace if necessary) and plug	Yearly	Service
General appliance overhaul • check all components, electrical equipment, corrosion, pipes...	Every 10 years ¹	Service

1. the appliance is designed and built for a duration of about 10 years. After this period of time (from commissioning) the appliance must undergo a general inspection and overhaul. Some examples of checks to be carried out are given below.

L.3 Periods of non-use

If the appliance is not going to be used for some time, take the following precautions:

- close the water supply tap(s), if present;
- disconnect the power supply or remove the plug from the power socket, if present;
- completely drain the tank(s);
- remove and carefully clean the filters;
- completely drain the boiler;
- completely drain the incorporated dispenser hoses. Remove them from the containers;
- carefully clean the internal parts of the appliance;
- clean the cabinet, going over all the stainless steel surfaces vigorously with a rag moistened with paraffin oil to create a protective film;
- periodically air the premises.

L.4 Boiler drainage (only for atmospheric versions)

If the appliance is not to be used for a long time, empty out the boiler to prevent any malfunction and/or mildew and unpleasant odours.

- Press simultaneously the buttons as shown in the figure.

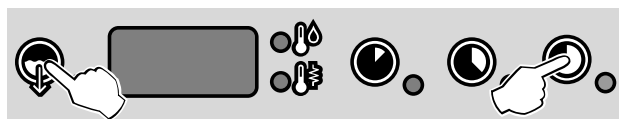
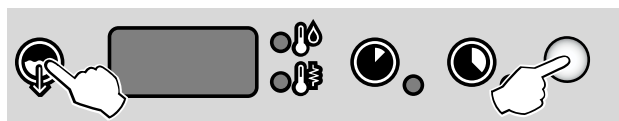

- A buzzer indicates completion of drainage.

L.5 Only for models with door lock device

Checks for inspection



NOTE!

On the right side of the machine there is a hole, indicated by a "CHECK POINT" label (see figure below), for accessing the washing chamber with a temperature measurer.

In this way it is possible to check the temperature reached by the dishes during the wash cycle (in accordance with the HTM [Health Technical Memorandum] 2030 guidelines).

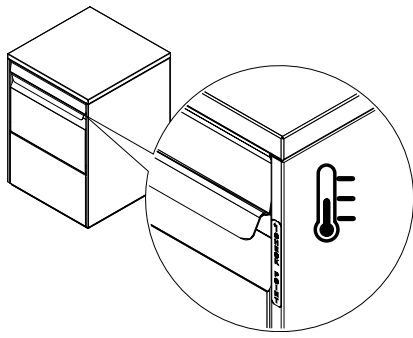

disposed of in compliance with current regulations in the country of use.

All metal parts are in stainless steel (AISI 304) and removable. Plastic parts are marked with the letters of the material.

The symbol  on the product indicates that this product should not be treated as domestic waste, but must be correctly disposed of in order to prevent possible negative consequences for the environment and the human health.

Regarding the recycling of this product, please contact the sales agent or dealer of your product, your Customer Care service or the appropriate waste disposal service.

L.6 Machine disposal

At the end of the product's life cycle, make sure the equipment is not dispersed in the environment. The equipment must be

M TROUBLESHOOTING

M.1 General troubleshooting

Anomaly	Type of anomaly	Possible causes	Actions
The dishwasher does not start	Blocking	The dishwasher is not connected to the main power supply.	Check if the appliance main circuit breaker is in ON position.
The dishwasher does not wash well.	Loss of performance.	No scrape action before putting dishes in the racks	Scrape dishes before putting them in the racks.
		The wash arms are clogged by solid food remains. Residual food has not been removed from dishes.	Check if the wash jets are clogged by solid food remains.
		The wash arms are not properly installed.	Check the integrity of the wash arms. Remove and fit again the wash arms.
		The dishes are not correctly placed in the racks.	Check if the dishes are correctly placed in the racks.
		The dosing of detergent is not correct.	Call detergent and rinse aid service centre.
		The detergent tank is empty.	Check that there is detergent in the container and if necessary top it up.
		Detergent pump does not work.	Call detergent and rinse aid service centre.
		The wash tank suction filter is dirty.	Clean wash tank suction filter thoroughly.
Glasses and dishes are not dried properly.	Loss of performance.	The container of rinse aid is empty.	Check that there is rinse-aid in the container and if necessary top it up.
		Rinse aid pump does not work.	Call detergent and rinse aid service centre.
		The rinse water temperature is too low.	Check if the rinse water temperature is between 82°C - 90°C. Call detergent and rinse aid service centre to set the temperature in according to the rinse aid specifications.
		Foamy detergent present in the wash tank.	Check if the dishes were not immersed in foamy detergent (e.g. hand wash detergent) before being put in the dishwasher. Only use "non-foaming" products for professional dishwashers.
Condensation on glasses.	Loss performance.	The container of rinse aid is empty.	Check that there is rinse-aid in the container and if necessary top up.
		Rinse aid pump does not work.	Call detergent and rinse aid service centre.

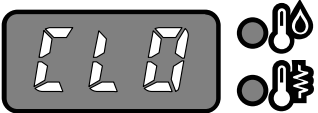
Anomaly	Type of anomaly	Possible causes	Actions
Stains on the glasses.	Loss of performance.	Foamy detergent present in the wash tank.	Only use "non-foaming" products for professional dishwashers.
		The dosing of rinse aid is not correct.	Call detergent and rinse aid service centre.
		the hardness of the water is too high or too low.	Adjust the amount of detergent and rinse aid. Call detergent and rinse aid service centre.
Excessive foam in the tank.	Loss performance.	Residuals of food or detergent, used for manual prewash, remains in the dishes.	Remove residuals of food or detergent from the dishes.
		Wash water temperature is too low.	Check if the water temperature of the wash module is between 55°C - 65°C. Call detergent and rinse aid service centre to set the temperature in according to the detergent specifications.
		Foamy detergent present in the wash tank.	Empty and refill the tank with water until the foam has been removed.
Smears or spots on the glasses.		Too much rinse-aid.	Reduce the amount of rinse-aid. Call detergent and rinse aid service centre.
Low pressure from wash arms.	Loss of performance	The tank filter is clogged. The wash pump filter is clogged. The water drainage hose is clogged. The wash pump does not work properly.	Clean the tank filter. Clean the wash pump filter. Call service centre. Call service centre.
Low pressure from rinse arms.	Loss of performance	The rinse arms are clogged. The water pressure after pressure reducer is less than 1 bar.	Clean the rinse arms. Call service centre.
The wash pump does not work.	Blocking	The wash pump is clogged.	Call service centre.
The drain pump does not work.	Loss of performance	The drain pump is clogged.	Call service centre.
The dishwasher is switched off, but the appliance continues to fill water.	Loss of performance	Inlet valve is damaged.	Close the water supply tap or taps and call service centre.
The display shows to close the door.  Once closed the door, the display shows the same anomaly.	Blocking	The magnetic switch door does not work.	Call service centre.

If the fault persists after carrying out the above checks, contact the Customer Care Service, remembering to specify:

- A. the type of fault;
- B. the appliance PNC (product number code);
- C. the Ser. No. (appliance serial number).



IMPORTANT

The appliance PNC and serial number are essential for identifying the type of appliance and date of manufacture.



NOTE!

For detailed information about the troubleshooting see the complete user manual in the web site.

M.2 Alarms

Anomaly	Type of anomaly	Possible causes	Actions
A1	NO WATER	The tap is close. The water inlet filter is clogged. Too low pressure in hydraulic circuit. Overflow not inserted (only for appliances without drain pump).	Open the tap. Clean the water inlet filter. Check the minimum mains pressure. Insert properly the overflow.
B1	INEFFICIENT DRAINAGE	Overflow not removed. The waste outlet pipe and/or the overflow aperture obstructed.	Remove the overflow. Remove any obstruction from the waste outlet pipe and/or the overflow aperture.
B2	TANK WATER LEVEL TOO HIGH	The waste outlet pipe and/or the overflow aperture obstructed.	Remove any obstruction from the waste outlet pipe and/or the overflow aperture.
C1 – C8			CALL THE SERVICE CENTRE
E1 – E8		The appliance continues to operate, but appropriate checks by a technician are recommended.	CALL THE SERVICE CENTRE
F21 – F22¹		Resin regeneration cycles are not performed. The appliance continues to operate without water softener.	CALL THE SERVICE CENTRE

1. Only for appliances with incorporated continuous water softener.

CE