

# Under Counter dishwasher



---

EN User manual \*



\*Original instructions

59566UW00- 2022.06

## Foreword

 Read the following instructions, including the warranty terms before installing and using the appliance.

**Visit our website [www.electroluxprofessional.com](http://www.electroluxprofessional.com) and open the Support section to:**

---

 Register your product

 Get hints & tips of your product, service and repair information

---

The installation, use and maintenance manual (hereinafter Manual) provides the user with information necessary for correct and safe use of the appliance.

The following must not be considered a long and exacting list of warnings, but rather a set of instructions suitable for improving appliance performance in every respect and, above all, preventing injury to persons and animals and damage to property due to improper operating procedures.

All persons involved in appliance transport, installation, commissioning, use and maintenance, repair and disassembly must consult and carefully read this manual before carrying out the various operations, in order to avoid wrong and improper actions that could compromise the appliance's integrity or endanger people. Make sure to periodically inform the user regarding the safety regulations. It is also important to instruct and update personnel authorised to operate on the appliance, regarding its use and maintenance.

The manual must be available to operators and carefully kept in the place where the appliance is used, so that it is always at hand for consultation in case of doubts or whenever required.

If, after reading this manual, there are still doubts regarding appliance use, do not hesitate to contact the Manufacturer or the authorised Service Centre to receive prompt and precise assistance for better operation and maximum efficiency of the appliance. During all stages of appliance use, always respect the current regulations on safety, work hygiene and environmental protection. It is the user's responsibility to make sure the appliance is started and operated only in optimum conditions of safety for people, animals and property.



### IMPORTANT

- The manufacturer declines any liability for operations carried out on the appliance without respecting the instructions given in this manual.
- The manufacturer reserves the right to modify the appliances presented in this publication without notice.
- No part of this manual may be reproduced.
- This manual is available in digital format by:
  - contacting the dealer or reference customer care;
  - downloading the latest and up to date manual on the web site [www.electroluxprofessional.com](http://www.electroluxprofessional.com);
- The manual must always be kept in an easily accessed place near the appliance. Appliance operators and maintenance personnel must be able to easily find and consult it at any time.

# Contents

|       |  |    |
|-------|--|----|
| A     | SAFETY INFORMATION   | 4  |
| A.1   | General information  | 4  |
| A.2   | General safety   | 4  |
| A.3   | Personal protection equipment                                    | 5  |
| A.4   | Water connection   | 5  |
| A.5   | Electrical connection  | 5  |
| A.6   | Machine cleaning and maintenance                                 | 6  |
| A.7   | Machine disposal   | 6  |
| B     | WARRANTY   | 6  |
| B.1   | Warranty terms and exclusions                                    | 6  |
| C     | GENERAL SAFETY RULES   | 7  |
| C.1   | Introduction   | 7  |
| C.2   | Mechanical safety characteristics, hazards                       | 7  |
| C.3   | Protection devices installed on the machine                      | 7  |
| C.3.1 | Guards   | 7  |
| C.3.2 | Safety devices   | 7  |
| C.4   | Safety signs to be placed on the machine or near its area        | 7  |
| C.5   | Instructions for use and maintenance                             | 7  |
| C.6   | Reasonably foreseeable improper use                              | 7  |
| C.7   | End of use   | 8  |
| C.8   | Residual risks   | 8  |
| D     | GENERAL INFORMATION  | 8  |
| D.1   | Introduction   | 8  |
| D.2   | Definitions  | 8  |
| D.3   | Machine and Manufacturer's identification data                   | 9  |
| D.4   | How to identify the technical data                               | 9  |
| D.4.1 | How to interpret the factory description                         | 9  |
| D.5   | Type reference   | 10 |
| D.6   | Responsibility   | 10 |
| D.7   | Copyright  | 10 |
| D.8   | Keeping the manual   | 10 |
| D.9   | Recipients of the manual   | 10 |
| E     | NORMAL USE   | 10 |
| E.1   | Correct use  | 10 |
| E.2   | Characteristics of personnel enabled to operate on the appliance | 10 |
| E.3   | Basic requirements for appliance use                             | 10 |
| F     | TECHNICAL DATA   | 11 |
| F.1   | Main technical characteristics for single phase appliances       | 11 |
| F.2   | Main technical characteristics for three phases appliances       | 12 |
| G     | PRODUCT DESCRIPTION  | 12 |
| G.1   | General description  | 12 |
| G.2   | Machine overview   | 13 |
| H     | CONTROL PANEL DESCRIPTION  | 13 |
| H.1   | Control panel description  | 13 |
| H.2   | Basic Controls   | 14 |
| I     | OPERATION  | 15 |
| I.1   | Starting   | 15 |
| I.2   | Loading dishes on racks  | 15 |
| I.3   | Type of racks and loading  | 15 |
| I.4   | Operation  | 16 |
| I.5   | Wash cycles  | 16 |
| I.6   | Regeneration cycle   | 17 |
| J     | DAILY CLEANING   | 18 |
| J.1   | Appliance cleaning   | 18 |
| J.2   | End of service   | 18 |
| K     | MAINTENANCE  | 19 |
| K.1   | Maintenance intervals  | 19 |
| K.1.1 | Preventive Maintenance   | 19 |
| K.2   | Maintenance frequency  | 19 |
| K.3   | Periods of non-use   | 20 |
| K.4   | Boiler drainage (only for atmospheric versions)                  | 20 |
| K.5   | Machine disposal   | 20 |
| L     | TROUBLESHOOTING  | 21 |
| L.1   | General troubleshooting  | 21 |
| L.2   | Alarms   | 22 |

---

## A SAFETY INFORMATION

---

### A.1 General information

These appliance is intended to be used for commercial applications, for example in kitchens of restaurant, canteens, hospitals. It must be used for washing plates, dishes, glassware, cutlery and similar articles.

To ensure safe use of the machine and a proper understanding of the manual it is necessary to be familiar with the terms and typographical conventions used in the documentation. The following symbols are used in the manual to indicate and identify the various types of hazards:



#### **WARNING**

Danger for the health and safety of operators.



#### **WARNING**

Danger of electrocution - dangerous voltage.



#### **CAUTION**

Risk of damage to the appliance or the product.



#### **IMPORTANT**

Important instructions or information on the product



Equipotentiality



Read the instructions before using the appliance







Clarifications and explanations

### A.2 General safety

- The appliance must not be used by people (including children) with limited physical, sensory or mental abilities or without experience and knowledge of it, unless instructed in its use and supervised by those responsible for their safety.
  - Do not let children play with the appliance.
  - Keep all packaging and detergents away from children.
  - Cleaning and user maintenance shall not be made by children without supervision.
- For suitable personal protection equipment, refer to chapter “A.3 *Personal protection equipment*”.
- Several illustrations in the manual show the machine, or parts of it, without guards or with guards removed. This is purely for explanatory purposes. Do not use the machine without the guards or with the protection devices deactivated.
- Do not remove, tamper with or make illegible the safety, danger and instruction signs and labels on the machine.
- Do not remove or tamper with the machine’s safety devices.
- Unauthorised personnel must not enter the work area.
- Remove any flammable products or items from the work area.

### A.3 Personal protection equipment

Summary table of the Personal Protection Equipment (PPE) to be used during the various stages of the appliance's service life.

| Stage                  | Protective garments<br> | Safety footwear<br> | Gloves<br> | Glasses<br> | Safety helmet<br> |
|------------------------|--|--|--|--|--|
| Transport              | —  | ●  | ○  | —  | ○  |
| Handling               | ●  | ●  | ○  | —  | —  |
| Unpacking              | ○  | ●  | ○  | —  | —  |
| Installation           | ○  | ●  | ● <sup>1</sup>   | —  | —  |
| Normal use             | ●  | ●  | ● <sup>2</sup>   | ○  | —  |
| Adjustments            | ○  | ●  | —  | —  | —  |
| Routine cleaning       | ○  | ●  | ● <sup>1-3</sup>   | ○  | —  |
| Extraordinary cleaning | ○  | ●  | ● <sup>1-3</sup>   | ○  | —  |
| Maintenance            | ○  | ●  | ○  | —  | —  |
| Dismantling            | ○  | ●  | ○  | ○  | —  |
| Scrapping              | ○  | ●  | ○  | ○  | —  |
| <b>Key:</b>            |  |  |  |  |  |
| ●                      | <b>PPE REQUIRED</b>  |  |  |  |  |
| ○                      | <b>PPE AVAILABLE OR TO BE USED IF NECESSARY</b>  |  |  |  |  |
| —                      | <b>PPE NOT REQUIRED</b>  |  |  |  |  |

1. During these operations, gloves must be cut-resistant. Failure to use the personal protection equipment by operators, specialized personnel or users can involve exposure to damage to health (depending on the model).

2. During these operations, gloves must be heatproof and suitable for contact with water and the substances used (refer to the safety data sheet of the substances used for the information regarding the required PPE). Failure to use the personal protection equipment by operators, specialised personnel or users can involve exposure to chemical risk and cause possible damage to health (depending on the model).

3. During these operations, gloves must be suitable for contact with chemical substances used (refer to the safety data sheet of the substances used for information regarding the required PPE). Failure to use the personal protection equipment by operators, specialized personnel or users can involve exposure to chemical risk and cause possible damage to health (depending on the model).

### A.4 Water connection

- The operating water pressure (minimum and maximum) must be between:
  - 2 bar [200 kPa] and 3 bar [300 kPa] for appliances without rinse pump;
  - 0.5 bar [50 kPa] and 7 bar [700 kPa] for appliances with rinse pump;
- Make sure that there are no visible water leaks during and after the first use of the machine.

### A.5 Electrical connection

- If the power cable is damaged it must be replaced by the Customer Care Service or in any case by specialised personnel, in order to prevent any risk.

## A.6 Machine cleaning and maintenance

- Depending on the model and type of electric connection, during maintenance operations, the cable and plug must be kept in a visible position by the operator carrying out the work.
- Do not touch the machine with wet hands or feet or when barefoot.
- Do not remove the safety guards.
- Use a ladder with suitable protection for work on machines with high accessibility.
- Respect the requirements for the various routine and extraordinary maintenance operations. Non compliance with the instructions can create risks for personnel.

### Ordinary maintenance

- Do not clean the machine with a water jet, a high pressure cleaner or a steam cleaner.

## A.7 Machine disposal

- Work on the electrical equipment must only be carried out by a specialised personnel, with the power supply disconnected.
- Dismantling operations must be carried out by specialised personnel.
- Make the appliance unusable by removing the power cable and any compartment closing devices, to prevent the possibility of someone becoming trapped inside.
- Refer to “A.3 *Personal protection equipment*” for suitable personal protection equipment.
- When scrapping the machine, the “CE” marking, this manual and other documents concerning the appliance must be destroyed.



### IMPORTANT

Save these instructions carefully for further consultation by the various operators.

---

## B WARRANTY

### B.1 Warranty terms and exclusions

If the purchase of this product includes warranty coverage, warranty is provided in line with local regulations and subject to the product being installed and used for the purposes as designed, and as described within the appropriate equipment documentation.

Warranty will be applicable where the customer has used only genuine spare parts and has performed maintenance in accordance with Electrolux Professional user and maintenance documentation made available in paper or electronic format.

Electrolux Professional strongly recommends using Electrolux Professional approved cleaning, rinse and descaling agents to obtain optimal results and maintain product efficiency over time.

The Electrolux Professional warranty does not cover:

- service trips cost to deliver and pick up the product;
- installation;
- training on how to use/operate;
- replacement (and/or supply) of wear and tear parts unless resulting from defects in materials or workmanship reported within one (1) week from the failure;
- correction of external wiring;
- correction of unauthorized repairs as well as any damages, failures and inefficiencies caused by and/or resulting from:
  - insufficient and/or abnormal capacity of the electrical systems (current/voltage/frequency, including spikes and/or outages);
  - inadequate or interrupted water supply, steam, air, gas (including impurities and/or other that does not comply with the technical requirements for each appliance);

- plumbing parts, components or consumable cleaning products that are not approved by the manufacturer;
  - customer’s negligence, misuse, abuse and/or non-compliance with the use and care instructions detailed within the appropriate equipment documentation;
  - improper or poor: installation, repair, maintenance (including tampering, modifications and repairs carried out by third parties not authorized) and modification of safety systems;
  - Use of non-original components (e. g.: consumables, wear and tear, or spare parts);
  - environment conditions provoking thermal (e. g. overheating/freezing) or chemical (e. g. corrosion/oxidation) stress;
  - foreign objects placed in- or connected to- the product;
  - accidents or force majeure;
  - transportation and handling, including scratches, dents, chips, and/or other damage to the finish of the product, unless such damage results from defects in materials or workmanship and is reported within one (1) week of delivery unless otherwise agreed;
- product with original serial numbers that have been removed, altered or cannot be readily determined;
  - replacement of light bulbs, filters or any consumable parts;
  - any accessories and software not approved or specified by Electrolux Professional.

Warranty does not include scheduled maintenance activities (including the parts required for it) or the supply of cleaning agents unless specifically covered within any local agreement, subject to local terms and conditions.

Check on Electrolux Professional website the list of authorized customer care.

## C GENERAL SAFETY RULES

### C.1 Introduction

The machines are provided with electric and/or mechanical safety devices for protecting workers and the machine itself.

Therefore the user must not remove or tamper with such devices. The Manufacturer declines any liability for damage due to tampering or their non-use.

### C.2 Mechanical safety characteristics, hazards

The machine does not have sharp edges or protruding parts. The guards for the moving and live parts are fixed to the cabinet with screws, to prevent accidental access.

### C.3 Protection devices installed on the machine

#### C.3.1 Guards

The guards on the machine are:



- fixed guards (e.g. casings, covers, side panels, etc.), fixed to the machine and/or frame with screws or quick-release connectors that can only be removed or opened with tools;
- interlocked movable guards (door) for access inside the machine;
- machine electrical equipment access doors, made from hinged panels openable with tools. The door must not be opened when the machine is connected to the power supply.



#### C.3.2 Safety devices

The machine has:

- a yellow/red main switch that acts as an emergency switch;
- interlocks on the front panels giving access to inside the machine;
- emergency switch push buttons and stops must be installed on the rack handling tables in case the racks exceed their travel.

### C.4 Safety signs to be placed on the machine or near its area

| Prohibition   | Meaning   |
|---|---|
|  | do not oil, lubricate, repair and adjust moving parts             |
|  | do not remove the safety devices                                  |
|  | do not use water to extinguish fires (placed on electrical parts) |

| Danger   | Meaning  |
|--|--|
|  | danger of crushing hands   |
|  | caution, hot surface   |
|  | danger of electrocution (shown on electrical parts with indication of voltage) |

### C.5 Instructions for use and maintenance

Risks mainly of a mechanical, thermal and electrical nature exist in the machine. Where possible the risks have been neutralised:

- directly, by means of adequate design solutions.
- indirectly by using guards, protection and safety devices.

Any anomalous situations are signalled on the control panel display.

During maintenance several risks remain, as these could not be eliminated, and must be neutralised by adopting specific measures and precautions.

Do not carry out any checking, cleaning, repair or maintenance operations on moving parts. Workers must be informed of this prohibition by means of clearly visible signs.

To guarantee machine efficiency and correct operation, periodical maintenance must be carried out according to the instructions given in this manual.

Make sure to periodically check correct operation of all the safety devices and the insulation of electrical cables, which must be replaced if damaged.

### C.6 Reasonably foreseeable improper use

Improper use is any use different from that specified in this manual. During appliance operation, other types of work or activities deemed improper and that in general can involve risks for the safety of operators and damage to the appliance are not allowed. Reasonably foreseeable improper use includes:

- lack of appliance maintenance, cleaning and periodical checks;
- structural changes or modifications to the operating logic;
- tampering with the guards or safety devices;
- failure to use personal protection equipment by operators, specialised personnel and maintenance personnel;
- failure to use suitable accessories (e.g. use of unsuitable equipment or ladders);
- keeping combustible or flammable materials, or in any case materials not compatible with or pertinent to the work, near the appliance;
- wrong appliance installation;
- placing in the appliance any objects or things not compatible with its use, or that can damage the appliance, cause injury or pollute the environment;
- climbing on the appliance;
- non-compliance with the requirements for correct appliance use;
- other actions that give rise to risks not eliminable by the Manufacturer.

## C.7 End of use

When the appliance is no longer to be used, make it unusable by removing the mains power supply wiring.

## C.8 Residual risks

The machine has several risks that were not completely eliminated from a design standpoint or with the installation of adequate protection devices. Nevertheless, through this manual the Manufacturer has taken steps to inform operators of such risks, carefully indicating the personal protection equipment to be used by them. In order to reduce the risks, provide for sufficient spaces while installing the unit. To preserve these conditions, the areas around the machine must always be:

- kept free of obstacles (e.g. ladders, tools, containers, boxes, etc.);
- clean and dry;
- well lit.

For the Customer's complete information, the residual risks remaining on the machine are indicated below: such situations are deemed improper and therefore strictly forbidden.

| Residual risk   | Description of hazardous situation   |
|---|--|
| Slipping or falling   | The operator can slip due to water or dirt on the floor  |
| Catching, dragging or crushing  | Catching or dragging of the operator or other persons in the drive, during the machine work phase, due to improper actions, such as: <ul style="list-style-type: none"> <li>• placing an arm inside the machine to remove a stuck rack without stopping the machine by operating an emergency switch;</li> <li>• accessing the rack handling system without stopping the machine by operating an emergency switch.</li> </ul> <p>Use of improper clothing with loose parts (e.g. necklaces, scarves, shawls, ties, etc.) or long hair not gathered, which could get caught up in moving parts.</p> |
| Burns/abrasions (e.g. heating elements, cold pan, cooling circuit plates and pipes) | The operator deliberately or unintentionally touches some components inside the machine without using protective gloves.   |

| Residual risk           | Description of hazardous situation  |
|-------------------------|---|
| Stab wounds             | The operator deliberately or unintentionally touches some components with sharp edges during the machine cleaning without using protective gloves.  |
| Burns                   | The operator deliberately or unintentionally touches some components inside the machine or dishes at the outfeed without using gloves or without allowing them to cool.                                   |
| Shearing of upper limbs | The operator violently closes the front panels.   |
| Electrocution           | Contact with live parts during maintenance operations carried out with the electrical panel powered   |
| Falling from above      | The operator intervenes on the machine using unsuitable systems to access the upper part (e.g. rung ladders, or climbs on it)   |
| Crushing or injury      | The specialised personnel may not correctly fix the control panel when accessing the technical compartment. The panel could close suddenly.   |
| Crushing or shearing    | Possible risk of injury to upper limbs during the hood closing operation.   |
| Tipping of loads        | When handling the machine or the packing containing it, using unsuitable lifting systems or accessories or with the unbalanced load   |
| Chemical                | Contact with chemical substances (e.g. detergent, rinse aid, scale remover, etc.) without taking adequate safety precautions. Therefore always refer to the safety cards and labels on the products used. |



### IMPORTANT

In case of a significant anomaly (e.g. short circuits, wires coming out of the terminal block, motor breakdowns, worn electrical cable sheathing, etc.) the operator must immediately deactivate the machine.

## D GENERAL INFORMATION

### D.1 Introduction

This manual contains information relevant to various appliances. The product images in this guide are only an example.

The drawings and diagrams given in the manual are not in scale. They supplement the written information with an outline, but are not intended to be a detailed representation of the appliance supplied.

The numerical values given on the appliance installation diagrams refer to measurements in millimeters and/or inches.

### D.2 Definitions

Listed below are the definitions of the main terms used in the manual. It is advisable to read them carefully before use.

|              |  |
|--------------|--|
| Operator     | machine installation, adjustment, use, maintenance, cleaning, repair and transport personnel.      |
| Manufacturer | Electrolux Professional SpA or any other service centre authorised by Electrolux Professional SpA. |



|   |  |
|---|--|
| Operator for normal machine use                 | an operator who has been informed and trained regarding the tasks and hazards involved in normal machine use.  |
| Customer Care service or specialised technician | an operator instructed/trained by the Manufacturer and who, based on his professional and specific training, experience and knowledge of the accident-prevention regulations, is able to appraise the operations to be carried out on the machine and recognise and prevent any risks. His professionalism covers the mechanical, electrotechnical and electronics fields. |
| Danger  | source of possible injury or harm to health.   |
| Hazardous situation                             | any situation where an operator is exposed to one or more hazards.   |
| Risk  | a combination of probabilities and risks of injury or harm to health in a hazardous situation.   |



|                       |   |
|-----------------------|---|
| Protection devices    | safety measures consisting of the use of specific technical means (guards and safety devices) for protecting operators against risks.   |
| Guard                 | an element of a machine used in a specific way to provide protection by means of a physical barrier.  |
| Safety device         | a device (other than a guard) that eliminates or reduces the risk; it can be used alone or in combination with a guard.   |
| Customer              | the person who purchased the machine and/or who manages and uses it (e.g. company, entrepreneur, firm).   |
| Emergency stop device | a group of components intended for the emergency stop function; the device is activated with a single action and prevents or reduces damage to persons/machines/property/animals. |
| Electrocution         | an accidental discharge of electric current on a human body.  |

### D.3 Machine and Manufacturer's identification data

A reproduction of the marking or dataplate on the machine is given below:

|  |       |              |       |                  |
|--|-------|--------------|-------|------------------|
| F.Mod.   | _____ | Comm. Model: | _____ | 2017             |
| PNC  | _____ | Ser.Nr.      | _____ |                  |
| EL   | _____ | Hz           | _____ | Max _____ kW     |
| Type ref.  | _____ | Min          | _____ | Nominal _____ kW |
|  |       |              |       | _____ kW         |
|    |       |              |       |                  |
| Electrolux Professional spa - Viale Treviso, 15 - 33170 Pordenone (Italy)  |       |              |       |                  |

The dataplate gives the product identification and technical data; listed below is the meaning of the various information given on it.

|  |  |
|--|--|
| F.Mod.   | factory description of product                   |
| Comm.Model   | commercial description                           |
| PNC  | production number code                           |
| Ser.No.  | serial number                                    |
| 400V 3N~   | power supply voltage                             |
| 230V 3 - 230V 1N   | electric convertibility (depending on the model) |
| Hz   | power supply frequency                           |
| Max – kW   | max. power                                       |
| Nominal – kW   | nominal power                                    |
| IPX4   | dust and water protection rating                 |
| CE   | CE marking                                       |
| Electrolux Professional SpA Viale Treviso 15 33170 Pordenone Italy | manufacturer                                     |

The dataplate is located on the right side panel of the equipment.

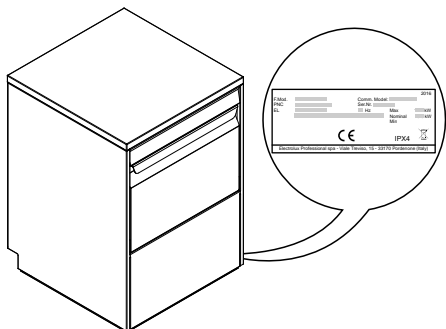

**WARNING**  
Do not remove, tamper with or make the machine marking illegible.

**IMPORTANT**  
When scrapping the machine, the marking must be destroyed.

**NOTE!**  
Refer to the data given on the machine marking for relations with the Manufacturer (e.g. when ordering spare parts, etc.).

### D.4 How to identify the technical data

To identify the technical data, read the factory description of the product (F. Mod.) on the dataplate, identify the main machine data and consult F TECHNICAL DATA paragraph.

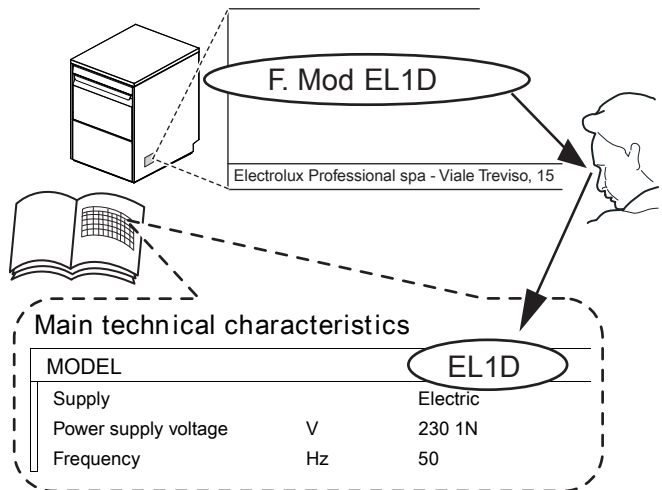

#### D.4.1 How to interpret the factory description

The factory description on the dataplate has the following meaning (some examples are given below):

| (1) | (2) | (3) | (4) | (5) | (6) | (7) |
|-----|-----|-----|-----|-----|-----|-----|
| E   | L   | 1   | G   | MS  |     |     |
| E   | L   | A   | 1   | W   | P   |     |
| E   | L   | A   | 3   | G   | TL  | 6   |

|                    |   |
|--------------------|---|
| (1) Brand          | E = Electrolux Professional, Z = Zanussi, V = Veetsan, N = To brand, C = Caterkwik.   |
| (2) Machine type   | L = Under counter   |
| (3) Rinsing system | A = Atmospheric<br>Empty = Pressure   |
| (4 - 7) Options    | 1 = Single phase<br>3 = Three phases<br>6 = 60 Hz<br>D = Detergent pump installed<br>P = Drain pump installed<br>G = Detergent and drain pumps installed<br>W = Water Softener installed<br>MS = Multi rack support<br>M = for Marine installation<br>OW = On Wheels<br>AG = AutoGrill<br>MCD = Mc Donalds<br>PR = Promotion code<br>TL = Thermal Label compliant<br>U = UK plug<br>S = Shuko plug<br>L = Stainless steel boiler in AISI316 |

## D.5 Type reference

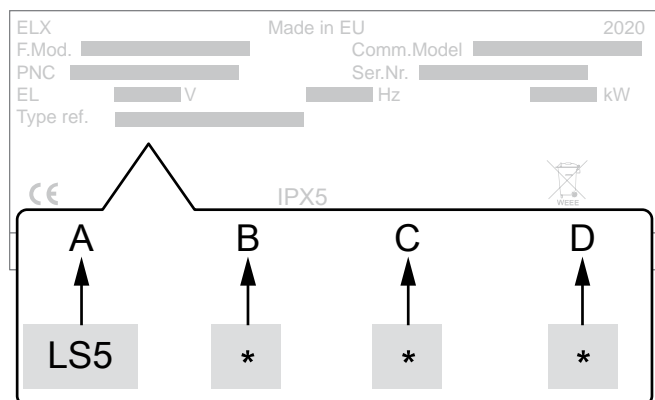

### Legend

|          |  |
|----------|--|
| <b>A</b> | Type of appliance <ul style="list-style-type: none"><li>• Under counter dishwasher</li></ul>   |
| <b>B</b> | Rinsing type <ul style="list-style-type: none"><li>• 0 = without rinse pump</li><li>• 1 = with rinse pump</li></ul>                                |
| <b>C</b> | Water treatment <ul style="list-style-type: none"><li>• 0 = without water softener [WS]</li><li>• 1 = with water softener [WS]</li></ul>           |
| <b>D</b> | Plug type <ul style="list-style-type: none"><li>• 0 = no plug</li><li>• 1 = UK plug (plug type G)</li><li>• 2 = Shuko plug (plug type F)</li></ul> |

## D.6 Responsibility

**The Manufacturer declines any liability for damage and malfunctioning caused by:**

- non-compliance with the instructions contained in this manual;
- repairs not carried out in a workmanlike fashion, and replacements with parts different from those specified in the spare parts catalogue (the fitting and use of non-original spare parts and accessories can negatively affect appliance

operation and invalidates the original manufacturer warranty);

- operations carried out by non-specialised personnel;
- unauthorized modifications or operations;
- missing, lack or inadequate maintenance;
- improper appliance use;
- unforeseeable extraordinary events;
- use of the appliance by uninformed and / or untrained personnel;
- non-application of the current provisions in the country of use, concerning safety, hygiene and health in the workplace.

The Manufacturer declines any liability for damage caused by arbitrary modifications and conversions carried out by the user or the Customer.

The employer, workplace manager or service technician are responsible for identifying and choosing adequate and suitable personal protection equipment to be worn by operators, in compliance with regulations in force in the country of use.

The Manufacturer declines any liability for inaccuracies contained in the manual, if due to printing or translation errors.

Any supplements to the installation, use and maintenance manual the Customer receives from the Manufacturer will form an integral part of the manual and therefore must be kept together with it.

## D.7 Copyright

This manual is intended solely for consultation by the operator and can only be given to third parties with the permission of Electrolux Professional company.

## D.8 Keeping the manual

The manual must be carefully kept for the entire life of the appliance, until scrapping. The manual must stay with the appliance in case of transfer, sale, hire, granting of use or leasing.

## D.9 Recipients of the manual

**This manual is intended for:**

- the employer of machine users and the workplace manager
- operators for normal machine use
- specialised technicians - Customer Care service (see service manual).

## E NORMAL USE

### E.1 Correct use

Our machines are designed and optimized in order to obtain high performance and efficiency.

This equipment must only be used for its expressly designed purpose, i. e. washing dishes with water and specific detergents. Any other use is to be deemed improper.

### E.2 Characteristics of personnel enabled to operate on the appliance

The Customer must make sure the personnel for normal appliance use are adequately trained and skilled in their duties.

The operator must:

- read and understand the manual;
- receive adequate training and instruction for their duties in order to operate safely;
- receive specific training for correct appliance use.



### IMPORTANT

The Customer must make sure his personnel have understood the instructions received and in particular those regarding work hygiene and safety in use of the appliance.

### E.3 Basic requirements for appliance use

- Knowledge of the technology and specific experience in operating the appliance.
- Adequate general basic education and technical knowledge for reading and understanding the contents of the manual, including correct interpretation of the drawings, signs and pictograms.
- Sufficient technical knowledge for safely performing his duties as specified in the manual.
- Knowledge of the regulations on work hygiene and safety.

## F TECHNICAL DATA

### F.1 Main technical characteristics for single phase appliances

| Model  |              | EL1...<br>ZL1...<br>NL1...<br>VL1...<br>CL1... | CL1G<br>EL1G<br>ZL1G<br>NL1G<br>VL1G                    | EL1P6<br>EL1G6M   | ELA1W<br>ELA1WP<br>ELA1P<br>ELA1PS              | CLA1G<br>ELA1G<br>NLA1G<br>ZLA1G                         | ELA1G6                             |
|--|--------------|--|---|---|---|--|------------------------------------|
| Supply voltage:                                      |              | 230V 1N~                                       | 230V 1N~  | 220 - 230V<br>1N~ [Only for<br>model EL1P6]<br>230V 1N~ | 230V 1N~  | 230V 1N~   | 220 - 230V<br>1N~                  |
| Convertible to:                                      |              | -  | -   | -   | -   | 400V 3N~<br>230V 3~                                      | 380 - 400V<br>3N~<br>220 - 230V 3~ |
| Frequency  | Hz           | 50   | 50  | 60  | 50  | 50   | 60                                 |
| Max. power   | kW           | 3.65 [5.65] <sup>1</sup>                       | 2.85 [4.35] <sup>1</sup>                                | 3.65 [5.65] <sup>1</sup>                                | 3.65 [5.65] <sup>1</sup>                        | 5.35 [7.35] <sup>1</sup>                                 | 5.35 [7.35] <sup>1</sup>           |
|  |              | 2.35 [Only<br>for model<br>CL1GU]              | 3.65 [5.65] <sup>1</sup><br>[Only for<br>model<br>CL1G] |   |   | 3.65 [5.65] <sup>1</sup><br>[Only for<br>model<br>NLA1G] |                                    |
|  |              | 3.65 [Only<br>for model<br>NL1PPR]             |   |   |   | 5.35 [Only<br>for model<br>NLA1G]                        |                                    |
| Boiler heating<br>elements                           | kW           | 2.8  | 1.5   | 2.8   | 2.8   | 4.5  | 4.5                                |
|  |              | 1.5 [Only for<br>model<br>CL1GU]               | 2.8 [Only for<br>model<br>CL1G]                         |   |   |  |                                    |
| Tank heating<br>elements                             | kW           | 2.0  | 2.0   | 2.0   | 2.0   | 2.0  | 2.0                                |
| Water supply<br>pressure                             | bar<br>[kPa] | 2 [200]  | 2 [200]   | 2 [200]<br>3 [300]                                      | 0.5 [50]<br>7 [700]                             | 0.5 [50]<br>7 [700]                                      | 0.5 [50]<br>7 [700]                |
|  |              | 3 [300]  | 3 [300]   |   |   |  |                                    |
| Water supply<br>temperature                          | °C           | 50<br>[65] <sup>2</sup>                        | 50  | 50  | 50  | 50   | 15 - 60                            |
| Water supply<br>hardness                             | °f/°d/°e     | 14/8/10<br>max                                 | 14/8/10<br>max  | 14/8/10 max   | 48/27/33.7<br>max<br>[14/8/10 max] <sup>3</sup> | 14/8/10 max  | 14/8/10 max                        |
| Electric conduc-<br>tivity of water                  | µS/cm        | < 400  | < 400   | < 400   | < 400   | < 400  | < 400                              |
| Concentration of<br>chlorides in<br>water            | ppm          | < 20   | < 20  | < 20  | < 20  | < 20   | < 20                               |
| Rinse cycle<br>water<br>consumption                  | l            | 3  | 3   | 3   | 3   | 3  | 3                                  |
| Boiler capacity                                      | l            | 5.8  | 5.8   | 5.8   | 5.8   | 5.8  | 5.8                                |
| Tank capacity  | l            | 33   | 33  | 33  | 33  | 33   | 33                                 |
| Standard cycle<br>time with water<br>supply at 50°C. | sec.         | 120 - 180                                      | 120 - 180   | 120 - 180   | 120 - 180                                       | 90 - 180   | 60 - 120                           |
|  |              | 90 - 180<br>[Only for<br>model<br>ZL1GMS]      |   |   | 90 - 120 - 240 <sup>3</sup>                     |  |                                    |
| Legal noise level<br>Leq <sup>4</sup>                | dB(A)        | LpA: 63dB - KpA: 1.5dB                         |   |   |   |  |                                    |
| Protection rating                                    |              | IPX4   |   |   |   |  |                                    |
| Power supply cable                                   |              | H07RN-F  |   |   |   |  |                                    |

1. If activated by software, coincidence of tank and boiler heating elements.

2. Only for models EL1GMS - VL1GMS - ZL1GMS.

3. Only for model ELA1P

4. The noise emission values have been obtained according to EN ISO 11204.

## F.2 Main technical characteristics for three phases appliances

| Model  |              | EL3...<br>ZL3...<br>NL3...<br>VL3... | EL3G<br>ZL3G<br>NL3G<br>VL3G | ELA3W...<br>ZLA3W...<br>NLA3W...<br>VLA3WG<br>ELA3GWP | ELA3G...<br>ZLA3G...<br>VLA3G...                                       | ELA3GTL<br>EL3PO-<br>WAG<br>ZLA3  | ELA3G6<br>ELA3GTL6   |
|--|--------------|--------------------------------------|------------------------------|---|--|---|--|
| Supply voltage:                                |              | 400V 3N~                             | 400V 3N~                     | 400V 3N~  | 400V 3N~   | 400V 3N~  | 230V 3~  |
| Convertible to:                                |              | 230V 3~<br>230V 1N~                  | 230V 3~<br>230V 1N~          | 230V 3~<br>230V 1N~                                   | 230V 3~<br>230V 1N~  | 230V 3~<br>230V 1N~   | 400V 3N~<br>230V 1N~   |
| Frequency                                      | Hz           | 50                                   | 50                           | 50  | 50   | 50  | 60   |
| Max. power                                     | kW           | 5.35 [7.35] <sup>1</sup>             | 5.35 [7.35] <sup>1</sup>     | 5.35 [7.35] <sup>1</sup>                              | 5.35 [7.35] <sup>1</sup>   | 5.35 [7.35] <sup>1</sup>  | 5.35 [7.35] <sup>1</sup>   |
| Boiler heating elements                        | kW           | 4.5                                  | 4.5                          | 4.5   | 4.5  | 4.5   | 4.5  |
| Tank heating elements                          | kW           | 2.0                                  | 2.0                          | 2.0   | 2.0  | 2.0   | 2.0  |
| Water supply pressure                          | bar<br>[kPa] | 2 [200]<br>3 [300]                   | 2 [200]<br>3 [300]           | 0.5 [50]<br>7 [700]                                   | 0.5 [50]<br>7 [700]  | 0.5 [50]<br>7 [700]   | 0.5 [50]<br>7 [700]  |
| Water supply temperature                       | °C           | 50                                   | 50                           | 50  | 10 - 60  | 10 - 60<br>50 [Only for models EL3PO-WAG - ZLA3]  | 10 - 60  |
| Water supply hardness                          | °f/°d/°e     | 14/8/10 max                          | 14/8/10 max                  | 48/27/33.7 max  | 14/8/10 max  | 14/8/10 max   | 14/8/10 max  |
| Electric conductivity of water                 | µS/cm        | < 400                                | < 400                        | < 400   | < 400  | < 400   | < 400  |
| Concentration of chlorides in water            | ppm          | < 20                                 | < 20                         | < 20  | < 20   | < 20  | < 20   |
| Rinse cycle water consumption                  | l            | 3                                    | 3<br>[2.1] <sup>2</sup>      | 3   | 3<br>[2.3] <sup>3</sup>  | 3 [Only for models EL3PO-WAG - ZLA3]<br>3 for cycle 1<br>4 for cycle 2<br>3.5 for cycle 3 | 3 [Only for model ELA3G6]<br>3 for cycle 1<br>4 for cycle 2<br>3.5 for cycle 3 |
| Boiler capacity                                | l            | 5.8                                  | 5.8                          | 5.8   | 5.8  | 5.8   | 5.8  |
| Tank capacity                                  | l            | 33                                   | 33                           | 33  | 33   | 33  | 33   |
| Standard cycle time with water supply at 50°C. | sec.         | 120 - 180                            | 120 - 180                    | 120 - 180 [Only for model VLA3WG]                     | 120 - 180 [Only for model ELA3GMCD]<br>90 - 180 [Only for model VLA3G] | 90 - 120 - 240  | 75 - 180 - 120<br>90 - 120 - 240 [Only for model ELA3GTL6]                     |
| Legal noise level Leq <sup>4</sup>             | dB(A)        | LpA: 63dB - KpA: 1.5dB               |                              |   |  |   |  |
| Protection rating                              |              | IPX4                                 |                              |   |  |   |  |
| Power supply cable                             |              | H07RN-F                              |                              |   |  |   |  |

1. If activated by software, coincidence of tank and boiler heating elements.
2. Only for model NL3G
3. Only for model ELA3G
4. The noise emission values have been obtained according to EN ISO 11204.

## G PRODUCT DESCRIPTION

### G.1 General description

The appliance is suitable for washing glasses, cups, cutlery. Under no circumstances it can be used for other applications or ways not provided for in this manual.

This equipment has been created in order to ensure a better work environment and cost efficiency.

These appliances are used in restaurants, cafeterias, cooking centers and large institutions. The special dish racks, that can be equipped with various inserts, offer practical and easy use for obtaining excellent washing results.

The electronic system enables complete supervision of the washing process. The control panel also has a display that shows the operating parameters and signals any faults.

## G.2 Machine overview

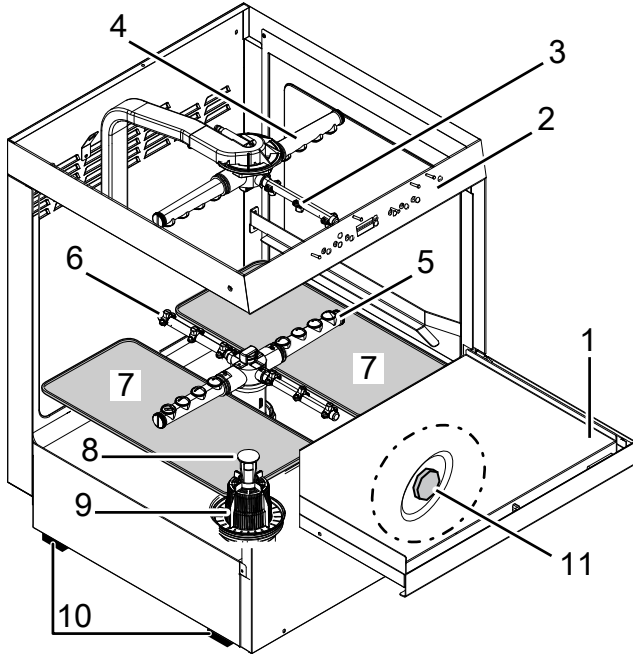

|    |   |
|----|---|
| 1  | Door                                    |
| 2  | Control panel                           |
| 3  | Upper rinse arm                         |
| 4  | Upper washer arm                        |
| 5  | Lower washer arm                        |
| 6  | Lower rinse arm                         |
| 7  | Flat filters                            |
| 8  | Overflow                                |
| 9  | Wash tank filter                        |
| 10 | Adjustable feet                         |
| 11 | Salt container (depending on the model) |

## H CONTROL PANEL DESCRIPTION

### H.1 Control panel description

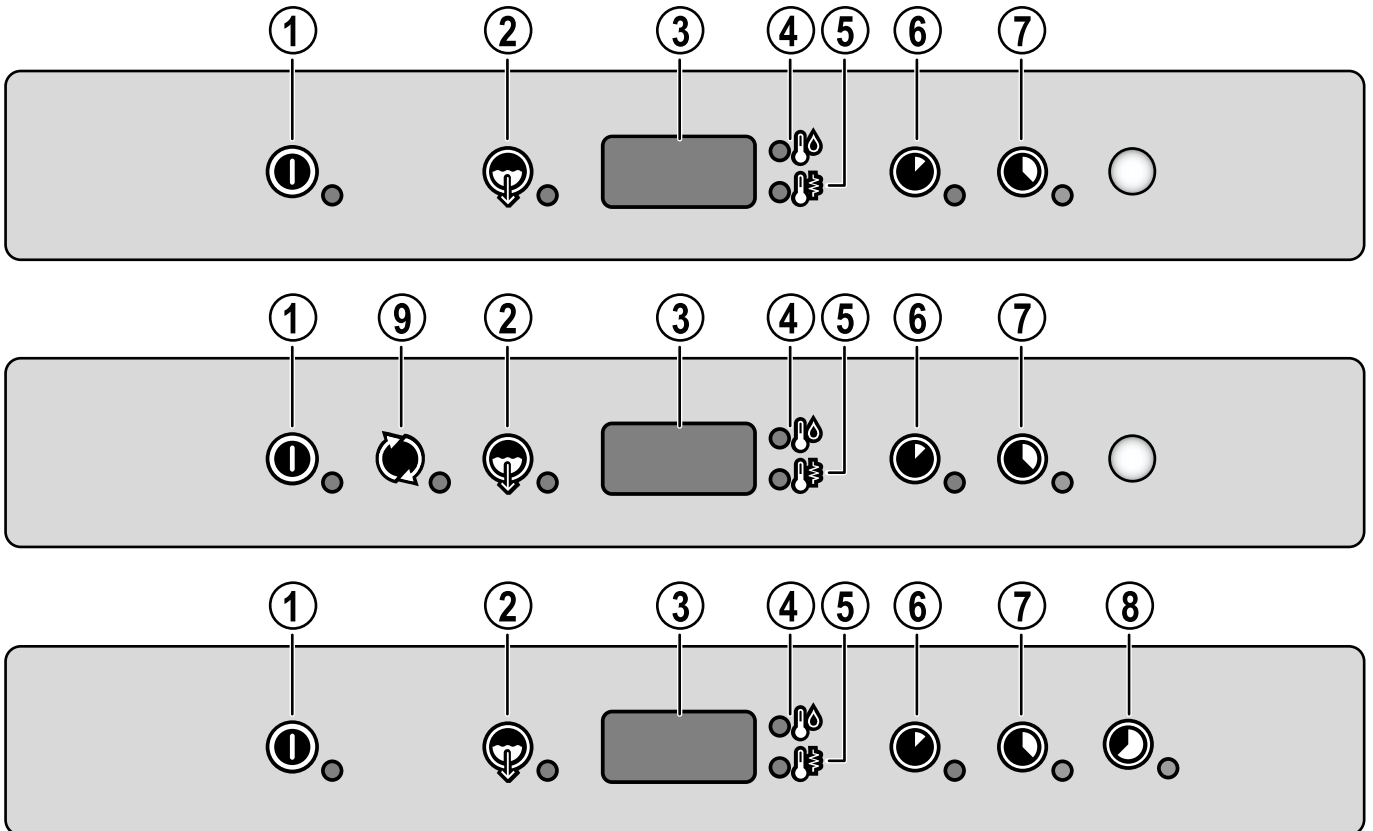

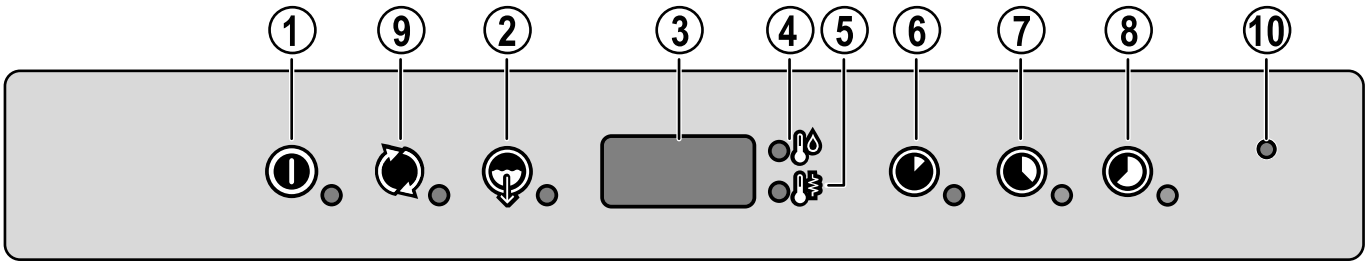

|   |                              |
|---|------------------------------|
| 1 | On/Off                       |
| 2 | Drain/self-cleaning cycle    |
| 3 | Display                      |
| 4 | Tank temperature indicator   |
| 5 | Boiler temperature indicator |
| 6 | Wash cycle 1                 |

**i** NOTE!  
Only for Singapore market, consider this wash programme for normal soiled washware.

|    |   |
|----|---|
| 7  | Wash cycle 2                                |
| 8  | Wash cycle 3                                |
| 9  | Regeneration cycle (depending on the model) |
| 10 | Active/Wash Safe Control indicator          |

**i** NOTE!  
The temperature shown on the display refers to the boiler if the indicator "5" is lit up or to the tank, if the indicator "4" is lit up.  
The tank temperature is displayed during the wash phase and the boiler temperature during the rinse phase.

## H.2 Basic Controls

Described below are all the single buttons and functions available in the various control panel models listed above. Some functions are common to all models of the range, whereas others are available only on some versions.

### On/Off

This button indicates equipment status: on or off. When the equipment is on, the button indicator is lit up.

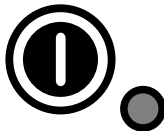

### Regeneration cycle

When on the display appears "rEG", press this button to activate the regeneration cycle of the water continuous softener. Please refer to chapter I.6 *Regeneration cycle*.



### Drain / self-cleaning cycle

This button starts a drain/self-cleaning cycle. When the cycle is selected, the button indicator is lit up.



### Wash cycle 1

This button starts **Wash cycle 1**. When the cycle is selected, the button indicator is lit up. This cycle is recommended for washing not very dirty dishes.



### Wash cycle 2

This button starts **Wash cycle 2**. When the cycle is selected, the button indicator is lit up. This cycle is recommended for washing normally dirty dishes.



### Wash cycle 3

This button starts **Wash cycle 3**. When the cycle is selected, the button indicator is lit up. This cycle is recommended for washing very dirty dishes.

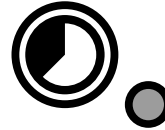

### Active/Wash Safe Control indicator



In the **Active/Wash Safe Control** models a special device checks the temperature of the rinse phase. The **GUARANTEED RINSE SYSTEM [GRS]** is an automatic rinse time/temperature control system.

The **GUARANTEED RINSE SYSTEM** is active:

- during the wash cycle and the indicator light is OFF;
- during the rinse cycle and the indicator light comes on and is GREEN;
- at the end of the rinse cycle. The indicator light is GREEN if the rinse temperature and time have been carried out as per the programme, otherwise the indicator light is RED;
- upon opening the door, the indicator light GOES OUT.

**i** NOTE!  
If the indicator light is RED, for example should the boiler waiting time be disabled, wait for a couple of minutes and then repeat the wash cycle.

# I OPERATION

## I.1 Starting



### NOTE!

Carry out a couple of cycles without dishes to flush out any industrial grease which has remained in the tank and piping.

- Open the water supply tap.
- Switch on at the mains.
- Open the door and check that all the components are in their correct position.
- Close the door and press On/Off button.

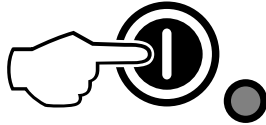

- The indicator light of On/Off button comes on, indicating that the dishwasher is powered and that water is being introduced and heated. The word "FILL" is shown on the display during the entire filling and heating stage:



### NOTE!

**For atmospheric versions only:** this dishwasher does the first tank filling through several consecutive hot rinse cycles, while the display shows the message "FILL" (flowing). This system let save up to 30% of time than traditional models.

- If the door is opened during this stage the message "CLOSE" will appear on the display:



- The filling and heating stage has finished when the display shows the tank temperature:



- To display the boiler temperature during heating of the tank, open the door and press the **Wash cycle 1** button.

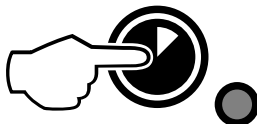

### IMPORTANT

For Thermal Label compliant models the display shows 75°C.

## I.2 Loading dishes on racks

The appliance is suitable for washing dishes, glasses, cups, cutlery, containers and receptacles in plastic and/or steel used for preparing, cooking and serving; as well as a wide variety of ceramic and/or metal cooking utensils. However it is advisable not to wash decorated dishes or place silverware in contact with other metals.



### IMPORTANT

The appliance does not remove burnt food deposits from dishes. Dishes with burnt-on food deposits should be cleaned mechanically/chemically before putting them in the dishwasher. Before inserting the racks in the machine, clear the dishes of any food residuals and rinse them with cold or warm water, at a max. temperature of 35°C [95°F], using a manual prewash spray.

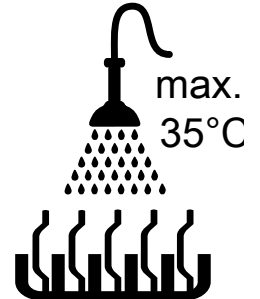

### CAUTION

Failure to remove the residuals of detergent possibly used for manual prewash can cause malfunctioning of the dishwasher and compromise washing results.



### IMPORTANT

This machine must only be used for washing dishes, containers, etc. (see above) do not use it to wash animals or food (e.g., fruit, vegetables, meat or fish).

## I.3 Type of racks and loading



### NOTE!

Not all these racks are available for each model.

- **YELLOW** rack: for 18 plates with maximum diameter of 240 mm.

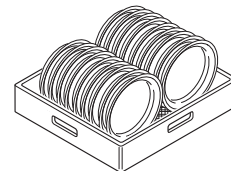

- **GREEN** rack: for 12 bowls with maximum diameter of 240 mm.

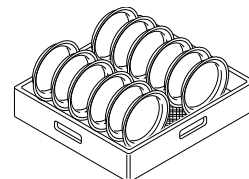

- **BLUE** rack for glasses: the glasses should be placed upside down.

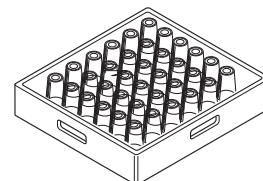

- **YELLOW** container for cutlery: insert items, with the handles pointing downwards, in each container.

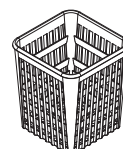

- Half size basket - universal (500 x 250 mm)

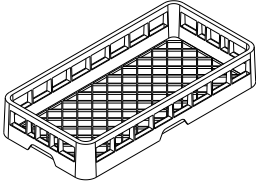

- Half-size basket for plates (500 x 250 mm)

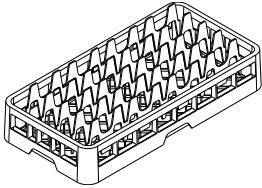

- Half size basket for glasses (500 x 250 mm)

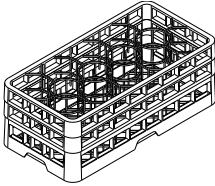

Available as accessories: dividers for glasses and rack for dishes with maximum diameter of 320 mm.



**IMPORTANT**

If only one type of dish rack is to be used, it is advisable to choose the GREEN rack.

**I.4 Operation**



**IMPORTANT**

- To guarantee sanitization of the dishes, wash at least 3 empty racks at lowest speed. This allows all the machine to reach the working temperature. Repeat the procedure if the machine is stopped or the door is opened for a long time.
- During normal daily operations, make sure to change the water in the tank at least twice a day.

The filling and heating stage has finished when the display shows the tank temperature. The appliance is then ready for use.

- Open the door.
- Only for model without detergent pump, pour the required amount of detergent into the tank.
- Insert the rack containing the dirty dishes.
- Close the door and select the suitable wash cycle; the corresponding indicator light comes on and the wash cycle starts:

• **Cycle I**

For lightly soiled dishes: press button **Wash cycle 1** (see table of times).

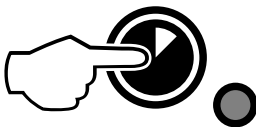

• **Cycle II** (recommended)

For very dirty dishes: press button **Wash cycle 2** (see table of times).

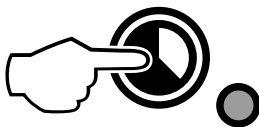

• **Cycle III**

For very dirty dishes: press button **Wash cycle 3** (see table of times).

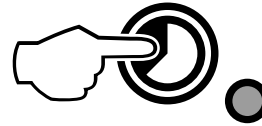

- To stop the wash cycle, just press the selected cycle button or open the door.
- To continue the wash cycle, press the cycle button again or close the door. The cycle starts again from where it was stopped.
- At the end of the wash, the dishwasher emits a series of beeps and the message "END" blinks on the display:

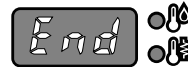

- Open the door and remove the rack containing the clean dishes.



**CAUTION**

The use of "foaming/nonspecific" detergents or in any case detergents used in different ways from that prescribed by the manufacturer, can cause damage to the dishwasher and compromise the washing results.

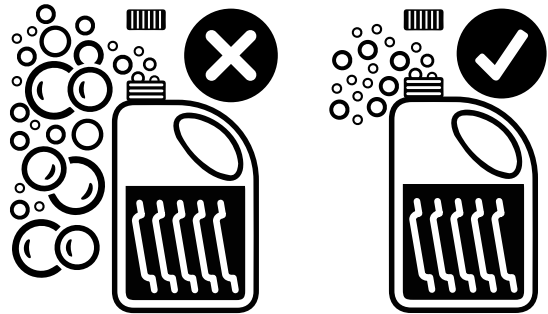

**NOTE!**

To obtain excellence washing performance, use detergent, rinse aid and descaling agent suggested by Electrolux Professional. In the Electrolux Professional web site, open the "Accessories and Consumables" web page and navigate into the dishwashing equipment tab to order most suitable detergents and accessories.

**I.5 Wash cycles**

The wash cycle includes one wash with hot water and detergent (min 55°C [131°F]) and one rinse with hot water and rinse-aid (min 82 °C [180°F]).



**NOTE!**

ELA3GTL and ELA3GTL6 models are designed to guarantee thermal sanitization with a temperature of 71°C [160°F] reached at tableware surface when operating continuously, loaded at 70% of nominal productivity (i.e. racks slightly spaced). Since the performance depends on the load and environmental and water feed condition, before starting washing operations it is suggested to test (using 71°C [160°F] thermal labels) a full-load rack to confirm the effectiveness of parameters; in case of test failure, a lower speed washing cycle must be set and the test repeated.



**Table of times: standard cycle time with supply water at 50°C [122°F]**

| Model   | 🕒       | 🕒       | 🕒       |
|---|---------|---------|---------|
| EL1... - ZL1... - NL1... - VL1... - CL1...      | 120 sec | 180 sec | -       |
| EL1G - ZL1G - NL1G - VL1G - CL1G                |         |         |         |
| EL1P6 - EL1G6M                                  |         |         |         |
| ELA1W - ELA1WP                                  |         |         |         |
| EL3... - ZL3... - NL3... - VL3...               |         |         |         |
| EL3G - ZL3G - NL3G - VL3G                       |         |         |         |
| ELA3W... - ZLA3W... - NLA3W...                  |         |         |         |
| ELA1G6  | 60 sec  | 120 sec | -       |
| ELA3G - ELA3G6 - ZLA3G                          | 75 sec  | 180 sec | 120 sec |
| ELA1G - ZLA1G - CLA1G - NLA1G<br>VLA3G - VLA3WG | 90 sec  | 180 sec | -       |
| ELA1P - ELA1PS - ZLA3 - ELA3GTL - ELA3GTL6      | 90 sec  | 120 sec | 240 sec |
| ELA3GMCD  | 120 sec | 180 sec | 240 sec |

**Table of times: standard cycle time with supply water at 65°C [149°F]**

| Model           | 🕒       | 🕒       | 🕒 |
|-----------------|---------|---------|---|
| EL1GMS - VL1GMS | 120 sec | 180 sec | - |
| ZL1GMS          | 90 sec  | 180 sec | - |

**i** NOTE!  
Standard cycle time may vary should the inlet water temperature and/or the boiler heating elements be different from that indicated above.

A device lengthens the cycle time if the water in the boiler has not reached the minimum temperature for correct rinsing.

The cycle times and the temperature may be personalised (e.g. increase of the rinse time and temperature). The cycle times should only be set by a specialised personnel.

## 1.6 Regeneration cycle

To reduce problems caused by the presence of calcareous substances in the water supply, a water softener device has been fitted in the rinse circuit of the dishwasher. This device removes the calcareous substances from the feed-water, supplying decalcified water necessary for the washing.

For the correct operation of the water softener, the periodical regeneration of the resins, whose frequency depends on the number of washing cycles and water hardness, must be carried out.

This dishwasher has a built-in counter which keeps track of how many wash cycles can be carried out before a regeneration cycle must take place.

The relevant water supply company will be able to provide all the instructions regarding the water hardness.

### Degrees of water hardness

| Level | Cycles    | Degrees   |        |           |
|-------|-----------|-----------|--------|-----------|
|       |           | °fH       | °dH    | °cH       |
| 1     | soft      | 0 – 5.5   | 0 – 3  | 0 – 4     |
| 2     | medium    | 7 – 14    | 4 – 8  | 5 – 10    |
| 3     | hard      | 16 – 26.5 | 9 – 15 | 11 – 18.6 |
| 4     | very hard | > 27      | > 16   | > 19      |

**Water hardness in °fH, °dH, °cH / Regeneration frequency in nr of cycles**

| °fH     | °dH         | °cH       | Nr  |
|---------|-------------|-----------|-----|
| 9 – 15  | 5.6 – 8.4   | 9 – 15    | 200 |
| 16 – 20 | 9.0 – 11.2  | 9 – 15    | 140 |
| 21 – 25 | 11.8 – 14.0 | 9 – 15    | 100 |
| 26 – 30 | 14.6 – 16.8 | 9 – 15    | 70  |
| 31 – 35 | 17.4 – 19.6 | 9 – 15    | 50  |
| 36 – 40 | 20.2 – 22.4 | 25.3 – 28 | 30  |

**i** NOTE!  
The water softener device is factory-set to the value of 20 cycles since this is generally sufficient for most uses. During installation of the appliance, the installation technician should nonetheless check the correct setting of this value.

The regeneration of the resins is carried out by means of a special regeneration cycle with coarse salt, following the instructions described hereinafter.

**⚠ CAUTION**  
Only use coarse salt with a purity level of 99.8% NaCl. The use of salt with a lower purity level can cause clogging of the salt container filter and malfunctioning of the water softener.

### Activation of the regeneration cycle

- When the message “REG” appears on the display, activate the cycle to regenerate the resins.



- Open the salt container.

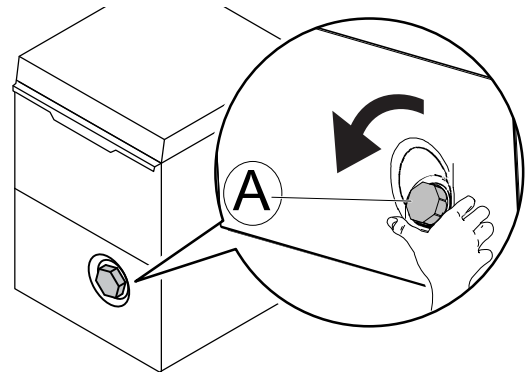

- Pour approximately 0.5 Kg of coarse salt [NaCl] (the amount necessary to fill the salt container up to the rim) into container “A”.

Remove any salt residue from around the salt container hole and screw the salt container top on again tightly.

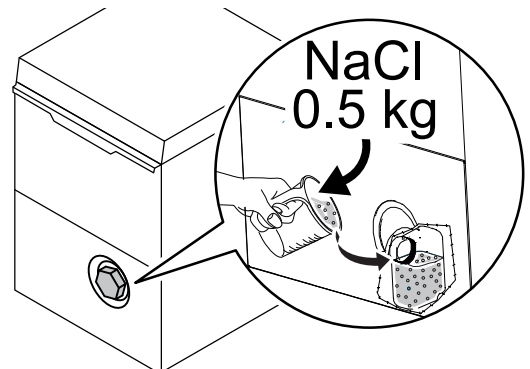



### CAUTION

Only salt may be placed in the salt container. Do not introduce any other chemical substances such as detergent, rinse aid or descaling agent, since these would inevitably damage the appliance. Such damage invalidates any warranty and relieves the manufacturer of all liability.

- Open the door and remove the overflow "A".

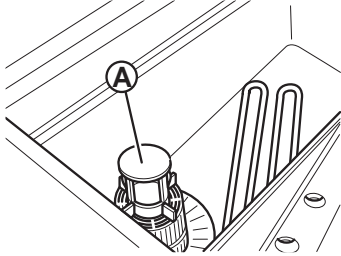

- Close the door.
- Start the regeneration cycle by pressing the REGENERATION cycle button for at least 5 seconds.



### CAUTION

Do not open the salt container during the entire regeneration cycle as the saline solution could spill out. During this process it is normal to hear a metallic sound for a short period.

- During the regeneration cycle the display alternately blinks two symbols: "0" and "[ ]":



- After about 50 minutes, 3 beeps indicate the end of the regeneration cycle and "END" blinks on the display:



- Replace the overflow.
- Close the door.

The dishwasher is now ready to start the normal working functions.



### IMPORTANT

If the regeneration cycle is accidentally started, it can be switched off by pressing the regeneration cycle button for at least 5 seconds.

### The regeneration cycle is temporarily stopped:

- in the event of a power failure,
- if the door is opened,
- if the machine is switched off.

When normal conditions are reinstated, the symbols "0" and "[ ]" will flash alternately on the display.

## J DAILY CLEANING



### WARNING

Refer to "Safety Information".

### J.1 Appliance cleaning

Cleaning must be carried out after every day of use. Use hot water, a neutral detergent/cleaner if necessary, and a soft brush or sponge. If another type of detergent is used, carefully follow the producer's instructions and observe the safety rules given in the information sheets provided with the product or substance.

In order to reduce the environmental impact of pollutants it is advisable to clean the appliance (externally and, where necessary, internally) with products that are more than 90% biodegradable.



### CAUTION

Do not use steel wool or similar material to clean stainless-steel surfaces. Do not use detergents containing chlorine.



### WARNING

When using chemicals, comply with the safety notes and dosage recommendations printed on the packaging. Refer to the chapter A.3 *Personal protection equipment* for handling chemical products.



### J.2 End of service

The appliance is designed to carry out an automatic cleaning cycle to help flush out any residues and to guarantee greater health and hygiene:

- Open the door and take out the rack containing the clean dishes.
- Remove the flat filters "C".

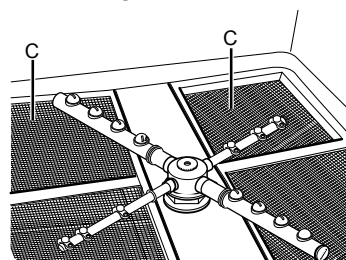

- Remove the overflow "A".

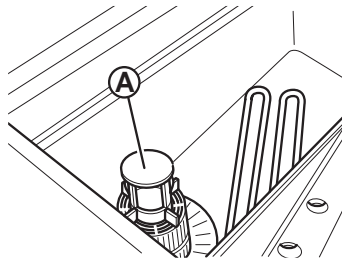

- Close the door. Select the drain cycle by pressing button Drain/Self cleaning cycle.

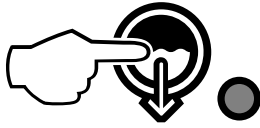

- The message "CLE" will be displayed throughout the drain cycle:



- After a few minutes, 3 beeps indicate the end of the cleaning cycle and the message "END" blinks on the display:



- Switch off the dishwasher by pressing ON/OFF button.

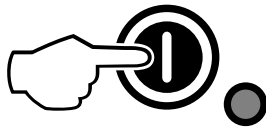

- Switch off at the mains.
- Close the water supply tap.
- Replace the filters and the overflow.
- Unscrew the ring nuts "H" and remove the header units "C".

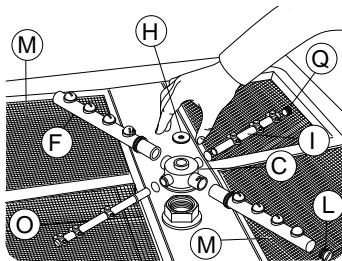

- Release the arms "F", "I" and "O" from the hub, remove the threaded plugs "L" and "Q".
- Carefully clean all the parts with a water jet and neutral detergent/detergent, if necessary using a soft brush or sponge. Do not use sharp implements to clean the nozzle holes, which could otherwise be damaged.
- Only if the filters "M" are present in the appliance, remove and clean them under a water spray.
- Remove the filter "Z" and clean away any remained food in order to avoid blocking the draining system.

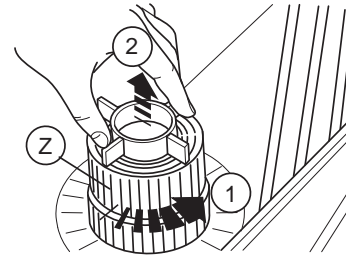

### CAUTION

The rinse arms "I" and "O" are not symmetrical; the rinse arm with raised ring ("O") should be fitted onto hub socket.

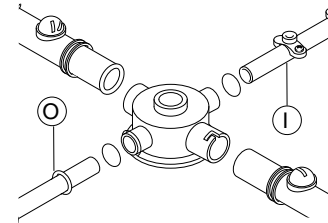

- Upon completion of cleaning operations, replace the parts removed previously.

## K MAINTENANCE

### K.1 Maintenance intervals

The inspection and maintenance intervals depend on the actual machine operating conditions and ambient conditions (presence of dust, damp, etc.), therefore precise time intervals cannot be given. In any case, careful and periodical machine maintenance is advisable in order to minimise service interruptions.

#### K.1.1 Preventive Maintenance

Preventive Maintenance reduces downtime and maximizes machines efficiency.

Customer Care Service can provide advice on the best maintenance plan to be purchased based on the intensity of use and the age of the equipment.

It is advisable to stipulate a preventive and scheduled maintenance contract with the Customer Care Service.

### K.2 Maintenance frequency

To ensure constant machine efficiency, it is advisable to carry out the checks with the frequency given in the following table:

| Maintenance, inspections, checks and cleaning  | Frequency | Responsibility |
|--|-----------|----------------|
| Ordinary cleaning<br>• general cleaning of machine and surrounding area                | Daily     | Operator       |
| Ordinary cleaning<br>• Every month descale the wash and rinse jets with vinegar.       | Monthly   | Operator       |
| Ordinary cleaning<br>• Every month descale the wash and rinse jets with scale remover. | Monthly   | Service        |

| Maintenance, inspections, checks and cleaning   | Frequency                   | Responsibility |
|---|-----------------------------|----------------|
| Mechanical protection devices <ul style="list-style-type: none"> <li>check their condition and for any deformation, loosening or removed parts</li> </ul>   | Monthly                     | Service        |
| Control <ul style="list-style-type: none"> <li>check the mechanical part, for cracks or deformation, tightening of screws: check the readability and condition of words, stickers and symbols and restore if necessary</li> </ul> | Yearly                      | Service        |
| Machine structure <ul style="list-style-type: none"> <li>Descale the boiler, inside surfaces of the tank and the machine piping.</li> </ul>   | Yearly                      | Service        |
| Machine structure <ul style="list-style-type: none"> <li>The internal hose of the rinse-aid and detergent peristaltic dispenser should undergo periodic maintenance.</li> </ul>   | Yearly                      | Service        |
| Machine structure <ul style="list-style-type: none"> <li>If present, clean the finned coil of the energy saving device.</li> </ul>  | Yearly                      | Service        |
| Machine structure <ul style="list-style-type: none"> <li>tightening of main bolts (screws, fixing systems, etc.) of machine</li> </ul>  | Yearly                      | Service        |
| Safety signs <ul style="list-style-type: none"> <li>check the readability and condition of safety signs</li> </ul>  | Yearly                      | Service        |
| Electrical control panel <ul style="list-style-type: none"> <li>check the electrical components installed inside the electrical control panel. Check the wiring between the electrical panel and machine parts.</li> </ul>        | Yearly                      | Service        |
| Electrical connection cable and plug <ul style="list-style-type: none"> <li>check the connection cable (replace if necessary) and plug</li> </ul>   | Yearly                      | Service        |
| General machine overhaul <ul style="list-style-type: none"> <li>check all components, electrical equipment, corrosion, pipes...</li> </ul>  | Every 10 years <sup>1</sup> | Service        |

1. the machine is designed and built for a duration of about 10 years. After this period of time (from commissioning) the machine must undergo a general inspection and overhaul. Some examples of checks to be carried out are given below.

### K.3 Periods of non-use

If the appliance is not going to be used for some time, take the following precautions:

- close the water supply tap(s), if present;

- disconnect the power supply or remove the plug from the power socket, if present;
- completely drain the tank(s);
- remove and carefully clean the filters;
- completely drain the boiler;
- completely drain the incorporated dispenser hoses. Remove them from the containers;
- carefully clean the internal parts of the appliance;
- clean the cabinet, going over all the stainless steel surfaces vigorously with a rag moistened with paraffin oil to create a protective film;
- leave the door or drawers, if present, open so that air can circulate inside, preventing the formation of unpleasant odours;
- periodically air the premises.



#### IMPORTANT

The warranty does not cover any damages caused by ice formations in the appliance pipes.

### K.4 Boiler drainage (only for atmospheric versions)

If the appliance is not to be used for a long time, empty out the boiler to prevent any malfunction and/or mildew and unpleasant odours.

- Press simultaneously the buttons as shown in the figure.

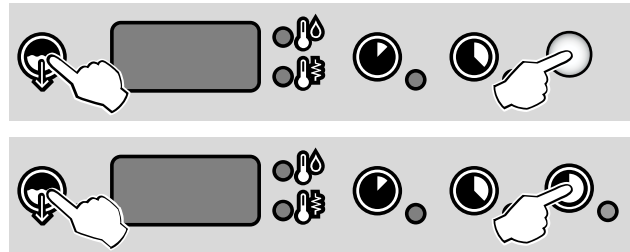

- A buzzer indicates completion of drainage.

### K.5 Machine disposal

At the end of the product's life cycle, make sure the equipment is not dispersed in the environment. The equipment must be disposed of in compliance with current regulations in the country of use.

All metal parts are in stainless steel (AISI 304) and removable. Plastic parts are marked with the letters of the material.



The symbol  on the product indicates that this product should not be treated as domestic waste, but must be correctly disposed of in order to prevent possible negative consequences for the environment and the human health.

Regarding the recycling of this product, please contact the sales agent or dealer of your product, your Customer Care service or the appropriate waste disposal service.

## L TROUBLESHOOTING

### L.1 General troubleshooting

| Anomaly                                    | Type of anomaly      | Possible causes  | Actions   |
|--|----------------------|--|---|
| The dishwasher does not start              | Blocking             | The dishwasher is not connected to the main power supply.  | Check if the appliance main circuit breaker is in ON position.  |
| The dishwasher does not wash well.         | Loss of performance. | No scrape action before putting dishes in the racks  | Scrape dishes before putting them in the racks.   |
|  |                      | The wash arms are clogged by solid food remains. Residual food has not been removed from dishes. | Check if the wash jets are clogged by solid food remains.   |
|  |                      | The wash arms are not properly installed.  | Check the integrity of the wash arms. Remove and fit again the wash arms.   |
|  |                      | The dishes are not correctly placed in the racks.  | Check if the dishes are correctly placed in the racks.  |
|  |                      | The dosing of detergent is not correct.  | Call detergent and rinse aid service centre.  |
|  |                      | The detergent tank is empty.   | Check that there is detergent in the container and if necessary top it up.  |
|  |                      | Detergent pump does not work.  | Call detergent and rinse aid service centre.  |
|  |                      | The wash tank suction filter is dirty.   | Clean wash tank suction filter thoroughly.  |
| Glasses and dishes are not dried properly. | Loss of performance. | The container of rinse aid is empty.   | Check that there is rinse-aid in the container and if necessary top it up.  |
|  |                      | Rinse aid pump does not work.  | Call detergent and rinse aid service centre.  |
|  |                      | The rinse water temperature is too low.  | Check if the rinse water temperature is between 82°C - 90°C.<br>Call detergent and rinse aid service centre to set the temperature in according to the rinse aid specifications.              |
|  |                      | Foamy detergent present in the wash tank.  | Check if the dishes were not immersed in foamy detergent (e.g. hand wash detergent) before being put in the dishwasher.<br>Only use "non-foaming" products for professional dishwashers.      |
| Condensation on glasses.                   | Loss performance.    | The container of rinse aid is empty.   | Check that there is rinse-aid in the container and if necessary top up.   |
|  |                      | Rinse aid pump does not work.  | Call detergent and rinse aid service centre.  |
| Stains on the glasses.                     | Loss of performance. | Foamy detergent present in the wash tank.  | Only use "non-foaming" products for professional dishwashers.   |
|  |                      | The dosing of rinse aid is not correct.  | Call detergent and rinse aid service centre.  |
|  |                      | the hardness of the water is too high or too low.  | Adjust the amount of detergent and rinse aid.<br>Call detergent and rinse aid service centre.   |
| Excessive foam in the tank.                | Loss performance.    | Residuals of food or detergent, used for manual prewash, remains in the dishes.                  | Remove residuals of food or detergent from the dishes.  |
|  |                      | Wash water temperature is too low.   | Check if the water temperature of the wash module is between 55°C - 65°C.<br>Call detergent and rinse aid service centre to set the temperature in according to the detergent specifications. |
|  |                      | Foamy detergent present in the wash tank.  | Empty and refill the tank with water until the foam has been removed.   |

| Anomaly   | Type of anomaly     | Possible causes   | Actions   |
|---|---------------------|---|---|
| Smears or spots on the glasses.   |                     | Too much rinse-aid.   | Reduce the amount of rinse-aid.<br>Call detergent and rinse aid service centre.                       |
| Low pressure from wash arms.  | Loss of performance | The tank filter is clogged.<br>The wash pump filter is clogged.<br>The water drainage hose is clogged.<br>The wash pump does not work properly. | Clean the tank filter.<br>Clean the wash pump filter.<br>Call service centre.<br>Call service centre. |
| Low pressure from rinse arms.   | Loss of performance | The rinse arms are clogged.<br>The water pressure after pressure reducer is less than 1 bar.  | Clean the rinse arms.<br>Call service centre.   |
| The wash pump does not work.  | Blocking            | The wash pump is clogged.   | Call service centre.  |
| The drain pump does not work.   | Loss of performance | The drain pump is clogged.  | Call service centre.  |
| The dishwasher is switched off, but the appliance continues to fill water.  | Loss of performance | Inlet valve is damaged.   | Close the water supply tap or taps and call service centre.   |
| The display shows to close the door.<br><br>Once closed the door, the display shows the same anomaly. | Blocking            | The magnetic switch door does not work.   | Call service centre.  |

If the fault persists after carrying out the above checks, contact the Customer Care Service, remembering to specify:

- A. the type of fault;
- B. the appliance PNC (product number code);
- C. the Ser. No. (appliance serial number).



#### IMPORTANT

The appliance PNC and serial number are essential for identifying the type of appliance and date of manufacture.



#### NOTE!

For detailed information about the troubleshooting see the complete user manual in the web site.

## L.2 Alarms

| Anomaly                      | Type of anomaly           | Possible causes  | Actions  |
|------------------------------|---------------------------|--|--|
| <b>A1</b>                    | NO WATER                  | The tap is close.<br>The water inlet filter is clogged.<br>Too low pressure in hydraulic circuit.<br>Overflow not inserted (only for appliances without drain pump). | Open the tap.<br>Clean the water inlet filter.<br>Check the minimum mains pressure.<br>Insert properly the overflow. |
| <b>B1</b>                    | INEFFICIENT DRAINAGE      | Overflow not removed.<br>The waste outlet pipe and/or the overflow aperture obstructed.  | Remove the overflow.<br>Remove any obstruction from the waste outlet pipe and/or the overflow aperture.              |
| <b>B2</b>                    | TANK WATER LEVEL TOO HIGH | The waste outlet pipe and/or the overflow aperture obstructed.   | Remove any obstruction from the waste outlet pipe and/or the overflow aperture.                                      |
| <b>C1 – C8</b>               |                           |  | CALL THE SERVICE CENTRE  |
| <b>E1 – E8</b>               |                           | The appliance continues to operate, but appropriate checks by a technician are recommended.  | CALL THE SERVICE CENTRE  |
| <b>F21 – F22<sup>1</sup></b> |                           | Resin regeneration cycles are not performed. The appliance continues to operate without water softener.  | CALL THE SERVICE CENTRE  |

1. Only for appliances with incorporated continuous water softener.



CE