

Undercounter dishwasher

Touch button version



EN User manual *



*Original instructions

59566XV00- 2024.06

Foreword

 Read the following instructions, including the warranty terms before installing and using the appliance.

Visit our website www.electroluxprofessional.com and open the Support section to:

-  Register your product
 -  Get hints & tips of your product, service and repair information
-

The installation, use and maintenance manual (hereinafter Manual) provides the user with information necessary for correct and safe use of the appliance.

The following must not be considered a long and exacting list of warnings, but rather a set of instructions suitable for improving appliance performance in every respect and, above all, preventing injury to persons and animals and damage to property due to improper operating procedures.

All persons involved in appliance transport, installation, commissioning, use and maintenance, repair and disassembly must consult and carefully read this manual before carrying out the various operations, in order to avoid wrong and improper actions that could compromise the appliance's integrity or endanger people. Make sure to periodically inform the user regarding the safety regulations. It is also important to instruct and update personnel authorised to operate on the appliance, regarding its use and maintenance.

The manual must be available to operators and carefully kept in the place where the appliance is used, so that it is always at hand for consultation in case of doubts or whenever required.

If, after reading this manual, there are still doubts regarding appliance use, do not hesitate to contact the Manufacturer or the authorised Service Centre to receive prompt and precise assistance for better operation and maximum efficiency of the appliance. During all stages of appliance use, always respect the current regulations on safety, work hygiene and environmental protection. It is the user's responsibility to make sure the appliance is started and operated only in optimum conditions of safety for people, animals and property.



IMPORTANT

- The manufacturer declines any liability for operations carried out on the appliance without respecting the instructions given in this manual.
- The manufacturer reserves the right to modify the appliances presented in this publication without notice.
- No part of this manual may be reproduced.
- This manual is available in digital format by:
 - contacting the dealer or reference customer care;
 - downloading the latest and up to date manual on the web site www.electroluxprofessional.com;
- The manual must always be kept in an easily accessed place near the appliance. Appliance operators and maintenance personnel must be able to easily find and consult it at any time.

Contents

A	WARNING AND SAFETY INFORMATION	5
A.1	General information	5
A.2	Personal protection equipment	5
A.3	General safety	6
A.4	Protection devices installed on the appliance	6
A.5	Safety signs to be placed on the appliance or near its area	7
A.6	Reasonably foreseeable improper use	7
A.7	Residual risks	7
A.8	Water connection	8
A.9	Electrical connection	8
A.10	Appliance cleaning	8
A.11	Preventive Maintenance	8
A.12	Parts and accessories	8
A.13	Precautions for use and maintenance	8
A.14	Appliance maintenance	9
B	WARRANTY	9
B.1	Warranty terms and exclusions	9
C	GENERAL SAFETY RULES	10
C.1	Introduction	10
C.2	Mechanical safety characteristics, hazards	10
C.3	Protection devices installed on the appliance	10
C.3.1	Guards	10
C.3.2	Safety devices	10
C.4	Safety signs to be placed on the appliance or near its area	10
C.5	Instructions for use and maintenance	10
C.6	End of use	10
D	GENERAL INFORMATION	10
D.1	Introduction	10
D.2	Testing and inspection	10
D.3	Definitions	10
D.4	Machine and Manufacturer's identification data	11
D.5	How to interpret the factory description	11
D.6	Type reference	11
D.7	Responsibility	12
D.8	Copyright	12
D.9	Keeping the manual	12
D.10	Recipients of the manual	12
E	NORMAL APPLIANCE USE	12
E.1	Characteristics of personnel enabled to operate on the appliance	12
E.2	Basic requirements for appliance use	12
F	TECHNICAL DATA	12
F.1	Main technical characteristics	12
G	PRODUCT DESCRIPTION	13
G.1	General description	13
G.2	Appliance overview	13
G.3	Type of racks and loading	13
H	CONTROL PANEL DESCRIPTION	14
H.1	Control panel	14
H.2	Basic control	14
H.2.1	Drain/self-cleaning icon	14
H.2.2	Secondary wash cycle icon	14
H.2.3	Control button	14
H.2.4	Connectivity icon	15
H.2.5	Alarm/Warning icon	15
I	APP CONNECTION	15
I.1	Intro	15
I.2	Register into One Connected	15
I.3	Download "AppOne" application	16
I.4	Login "AppOne" application with authentication (first use)	16
I.5	Login "AppOne" after authentication	18
J	PRIMING OF DETERGENTS	18
J.1	Detergent dispensers activation	18
J.1.1	Manual activation by control panel	18
J.1.2	Activation by "AppOne" application	18
K	DISPENSERS SETTING	19
K.1	Dispenser parameters	19
K.2	Change a parameter value	20
K.3	Detergent and rinse aid parameters list	21

L	USE	21
L.1	Starting	21
L.2	Loading dishes on racks.....	21
L.3	Operation	22
L.4	Wash cycles	22
L.5	View wash cycles details	22
L.6	Enable or disable secondary cycle	23
L.7	Check the appliance status by “ AppOne “ application	23
M	APPLIANCE CLEANING	24
M.1	Care information.....	24
M.2	Cleaning introduction.....	24
M.3	End of service	25
	M.3.1 Start the drain/self-cleaning cycle	25
	M.3.2 Clean wash tanks components.....	25
N	APPLIANCE MAINTENANCE.....	26
N.1	Maintenance frequency.....	26
N.2	Periods of non-use.....	27
N.3	Machine disposal.....	27
O	TROUBLESHOOTING	27
O.1	General troubleshooting.....	27
P	ALARMS.....	28
P.1	Anomaly details.....	28
	P.1.1 Alarm details	29
P.2	Alarm guide.....	30

A WARNING AND SAFETY INFORMATION

A.1 General information

To ensure safe use of the appliance and a proper understanding of the manual it is necessary to be familiar with the terms and typographical conventions used in the documentation. The following symbols are used in the manual to indicate and identify the various types of hazards:



WARNING

Danger for the health and safety of operators.



WARNING

Danger of electrocution - dangerous voltage.



CAUTION

Risk of damage to the appliance or the product.



IMPORTANT

Important instructions or information on the product



Equipotentiality



Read the instructions before using the appliance













Clarifications and explanations

- Only specialised personnel are authorised to operate on the appliance.
- This appliance is intended to be used for commercial applications, for example in kitchens of restaurant, canteens, hospitals. It must be used for washing or drying plates, dishes, glassware, cutlery and similar articles.
- This appliance is not intended for use by persons (including children) with reduced physical, sensor or mental capabilities, or lack of experience and knowledge, unless they have been given supervision or instruction concerning use of appliance by a person responsible for their safety.
- Do not let children play with the appliance.
- Keep all packaging and detergents away from children.
- Cleaning and user maintenance shall not be made by children without supervision.
- For your safety do not store or use gasoline or other flammable materials, vapours and liquids in the vicinity of this or any other appliance.
- Do not store explosive substances, such as pressurized containers with flammable propellant, in this appliance.
- Refer to the data given on the appliance's data plate for relations with the Manufacturer (e.g. when ordering spare parts, etc.).
- When scrapping the appliance, the marking CE must be destroyed.
- Save these instructions carefully for further consultation by the various operators.

A.2 Personal protection equipment

Summary table of the Personal Protection Equipment (PPE) to be used during the various stages of the appliance's service life.

Stage	Protective garments 	Safety footwear 	Gloves 	Glasses 	Safety helmet 
Transport	—	●	○	—	○
Handling	●	●	○	—	—
Unpacking	○	●	○	—	—
Installation	○	●	● ¹	—	—
Normal use	●	●	● ²	○	—
Adjustments	○	●	—	—	—
Routine cleaning	○	●	● ¹⁻³	○	—
Extraordinary cleaning	○	●	● ¹⁻³	○	—
Maintenance	○	●	○	—	—

Stage	Protective garments	Safety footwear	Gloves	Glasses	Safety helmet
					
Dismantling	○	●	○	○	—
Scrapping	○	●	○	○	—
Key:					
●	PPE REQUIRED				
○	PPE AVAILABLE OR TO BE USED IF NECESSARY				
—	PPE NOT REQUIRED				

1. During these operations, gloves must be cut-resistant. Failure to use the personal protection equipment by operators, specialized personnel or users can involve exposure to harm to health (depending on the model).
2. During these operations, gloves must be heatproof and suitable for contact with water and the substances used (refer to the safety data sheet of the substances used for the information regarding the required PPE). Failure to use the personal protection equipment by operators, specialised personnel or users can involve exposure to chemical risk and cause possible harm to health (depending on the model).
3. During these operations, gloves must be suitable for contact with chemical substances used (refer to the safety data sheet of the substances used for information regarding the required PPE). Failure to use the personal protection equipment by operators, specialized personnel or users can involve exposure to chemical risk and cause possible harm to health (depending on the model).

A.3 General safety

- The appliances are provided with electric and/or mechanical safety devices for protecting workers and the appliance itself.
- Never operate the appliance, removing, modifying or tampering with the guards, protection or safety devices.
- Do not make any modifications to the parts supplied with the appliance.
- Several illustrations in the manual show the appliance, or parts of it, without guards or with guards removed. This is purely for explanatory purposes. Do not use the appliance without the guards or with the protection devices deactivated.

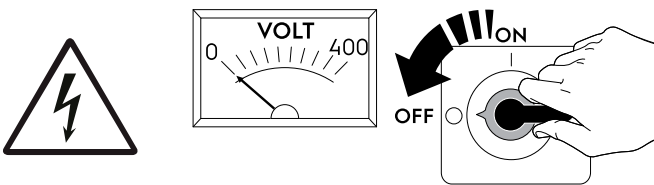

Disconnect the appliance from the power supply before carrying out any installation, assembly, cleaning or maintenance procedure.

- Do not remove, tamper with or make illegible the CE marking, the safety, danger and instruction signs and labels on the appliance.
- The A-weighted emission sound pressure level does not exceed 70 dB(A).
- The following operations have to be carried out by specialised authorised personnel or Customer Care Service provided with all the appropriate personal protection equipment (A.2 *Personal protection equipment*), tools, utensils and ancillary means, who can ask the manufacturer to supply a servicing manual:
 - Installation and assembly
 - Positioning
 - Electrical connection
 - Appliance cleaning, repair and extraordinary maintenance
 - Appliance disposal
 - Work on electrical equipment

A.4 Protection devices installed on the appliance

Guards

The appliance has:







- fixed guards (e.g. casings, covers, side panels, etc.), fixed to the appliance and/or frame with screws or quick-release connectors that can only be removed or opened with tools; therefore the user must not remove or tamper with such devices. The Manufacturer declines any liability for damage due to tampering or their non-use;
- interlocked movable guards (door) for access inside the appliance;
- appliance electrical equipment access panels or doors, made from hinged panels openable with tools. The panel or the door must not be opened when the appliance is connected to the power supply.

Safety devices

The appliance has:

- interlocks on the door(s) giving access to inside the appliance;

A.5 Safety signs to be placed on the appliance or near its area

Prohibition	Meaning
	do not oil, lubricate, repair and adjust moving parts
	do not remove the safety devices
	do not use water to extinguish fires (placed on electrical parts)
Danger	Meaning
	danger of crushing hands
	caution hot surface
	danger of electrocution (shown on electrical parts with indication of voltage)

A.6 Reasonably foreseeable improper use

Improper use is any use different from that specified in this manual. During appliance operation, other types of work or activities deemed improper and that in general can involve risks for the safety of operators and damage to the appliance are not allowed. Reasonably foreseeable improper use includes:

- lack of appliance maintenance, cleaning and periodical checks;
- structural changes or modifications to the operating logic;
- tampering with the guards or safety devices;
- failure to use personal protection equipment by operators, specialised personnel and maintenance personnel;
- failure to use suitable accessories (e.g. use of unsuitable equipment or ladders);
- keeping combustible or flammable materials, or in any case materials not compatible with or pertinent to the work, near the appliance;
- wrong appliance installation;
- placing in the appliance any objects or things not compatible with its use, or that can damage the appliance, cause injury or pollute the environment;
- climbing on the appliance;
- non-compliance with the requirements for correct appliance use;
- other actions that give rise to risks not eliminable by the Manufacturer.

A.7 Residual risks

The appliance has several risks that were not completely eliminated from a design standpoint or with the installation of adequate protection devices. Nevertheless, through this manual the Manufacturer has taken steps to inform operators of such risks, carefully indicating the personal protection equipment to be used by them. In order to reduce the risks, provide for sufficient spaces while installing the unit.

To preserve these conditions, the areas around the appliance must always be:

- kept free of obstacles (e.g. ladders, tools, containers, boxes, etc.);
- clean and dry;
- well lit.

For the Customer's complete information, the residual risks remaining on the appliance are indicated below: such actions are deemed improper and therefore strictly forbidden.

Residual risk	Description of hazardous situation
Slipping or falling	The operator can slip due to water, any liquid or dirt on the floor
Catching, dragging or crushing	Catching or dragging of the operator or other persons in the drive, during the appliance work phase, due to improper actions, such as: <ul style="list-style-type: none"> placing an arm inside the appliance to remove a stuck rack without stopping the appliance by operating an emergency switch; accessing the rack handling system without stopping the appliance by operating an emergency switch. Use of improper clothing with loose parts (e.g. necklaces, scarves, shawls, ties, etc.) or long hair not gathered, which could get caught up in moving parts.
Burns/abrasions (e.g. heating elements, cold pan, cooling circuit plates and pipes)	The operator deliberately or unintentionally touches some components inside the appliance without using protective gloves.
Stab wounds	The operator deliberately or unintentionally touches some components with sharp edges during the appliance cleaning without using protective gloves.
Burns	The operator deliberately or unintentionally touches some components inside the appliance or dishes at the outfeed without using gloves or without allowing them to cool.
Electrocution	Contact with live parts during maintenance operations carried out with the electrical panel powered
Falling from above	The operator intervenes on the appliance using unsuitable systems to access the upper part (e.g. rung ladders, or climbs on it)
Crushing or injury	The specialised personnel may not correctly fix the control panel when accessing the technical compartment. The panel could close suddenly.
Crushing or shearing	Possible risk of injury to upper limbs during the hood closing operation.
Tipping of loads	When handling the appliance or the packing containing it, using unsuitable lifting systems or accessories or with the unbalanced load
Chemical	Contact with chemical substances (e.g. detergent, rinse aid, scale remover, etc.) without taking adequate safety precautions. Therefore always refer to the safety cards and labels on the products used.
Shearing of upper limbs	The operator for normal appliance use could suddenly and deliberately close the doors/front panels (if present, depending on the appliance type).

A.8 Water connection

- The operating water pressure (minimum and maximum) must be between:
 - 2 bar [200 kPa] and 5 bar [500 kPa] for appliances without rinse pump;
- Make sure that there are no visible water leaks during and after the first use of the machine.

A.9 Electrical connection

- If the power cable is damaged it must be replaced by the Customer Care Service or in any case by specialised personnel, in order to prevent any risk.

A.10 Appliance cleaning

- Do not touch the appliance with wet hands or feet or when barefoot.
- Use a ladder with suitable protection for work on appliances with high accessibility.
- Put the appliance in safe conditions before starting any cleaning operation.
- Respect the requirements for the various routine and extraordinary maintenance operations. Non-compliance with the instructions can create risks for personnel.
- Do not spray water or use water jets, steam cleaner or high pressure cleaner.

A.11 Preventive Maintenance

In order to ensure the safety and performance of your equipment, it is recommended that service is undertaken by Electrolux Professional SpA authorised engineers every 12 months, in accordance with Electrolux Professional SpA Service Manuals. Please contact your local Electrolux Professional SpA Service Centre for further details.

A.12 Parts and accessories

Use only original accessories and/or spare parts. Failure to use original accessories and/or spare parts will invalidate the original manufacturer warranty and may render the appliance not compliant with the safety standard.

A.13 Precautions for use and maintenance

- Risks mainly of a mechanical, thermal and electrical nature exist in the appliance. Where possible the risks have been neutralised:
 - directly, by means of adequate design solutions.
 - indirectly by using guards, protection and safety devices.
- Any anomalous situations are signalled on the control panel display.

- During maintenance several risks remain, as these could not be eliminated, and must be neutralised by adopting specific measures and precautions.
- Do not carry out any checking, cleaning, repair or maintenance operations on moving parts. Workers must be informed of this prohibition by means of clearly visible signs.
- Make sure to periodically check correct operation of all the safety devices and the insulation of electrical cables, which must be replaced if damaged.

In case of a significant anomaly (e.g. short circuits, wires coming out of the terminal block, motor breakdowns, worn electrical cable sheathing, etc.) the operator for normal appliance use must:

- immediately deactivate the appliance.
- if present, close the appliance water supply by shutting off the water.

A.14 Appliance maintenance

- The inspection and maintenance intervals depend on the actual appliance operating conditions and ambient conditions (presence of dust, damp, etc.), therefore precise time intervals cannot be given. In any case, careful and periodical appliance maintenance is advisable in order to minimise service interruptions.
- It is advisable to stipulate a preventive and scheduled maintenance contract with the Customer Care Service.
- Put the appliance in safe conditions before starting any maintenance operation.
- To guarantee appliance efficiency and correct operation, periodical maintenance must be carried out according to the instructions given in the manual.

B WARRANTY

B.1 Warranty terms and exclusions

If the purchase of this product includes warranty coverage, warranty is provided in line with local regulations and subject to the product being installed and used for the purposes as designed, and as described within the appropriate equipment documentation.

Warranty will be applicable where the customer has used only genuine spare parts and has performed maintenance in accordance with Electrolux Professional user and maintenance documentation made available in paper or electronic format.

Electrolux Professional strongly recommends using Electrolux Professional approved cleaning, rinse and descaling agents to obtain optimal results and maintain product efficiency over time.

The Electrolux Professional warranty does not cover:

- service trips cost to deliver and pick up the product;
- installation;
- training on how to use/operate;
- replacement (and/or supply) of wear and tear parts unless resulting from defects in materials or workmanship reported within one (1) week from the failure;
- correction of external wiring;
- correction of unauthorized repairs as well as any damages, failures and inefficiencies caused by and/or resulting from;
 - insufficient and/or abnormal capacity of the electrical systems (current/voltage/frequency, including spikes and/or outages);
 - inadequate or interrupted water supply, steam, air, gas (including impurities and/or other that does not comply with the technical requirements for each appliance);
 - plumbing parts, components or consumable cleaning products that are not approved by the manufacturer;

- customer's negligence, misuse, abuse and/or non-compliance with the use and care instructions detailed within the appropriate equipment documentation;
- improper or poor: installation, repair, maintenance (including tampering, modifications and repairs carried out by third parties not authorized) and modification of safety systems;
- Use of non-original components (e.g.: consumables, wear and tear, or spare parts);
- environment conditions provoking thermal (e.g. overheating/freezing) or chemical (e.g. corrosion/oxidation) stress;
- foreign objects placed in- or connected to- the product;
- accidents or force majeure;
- transportation and handling, including scratches, dents, chips, and/or other damage to the finish of the product, unless such damage results from defects in materials or workmanship and is reported within one (1) week of delivery unless otherwise agreed;
- product with original serial numbers that have been removed, altered or cannot be readily determined;
- replacement of light bulbs, filters or any consumable parts;
- any accessories and software not approved or specified by Electrolux Professional.

Electrolux Professional warranty will be void and manufacturer shall have no liability related thereto in case of any modification of the product or related hardware/software/programming.

Warranty does not include scheduled maintenance activities (including the parts required for it) or the supply of cleaning agents unless specifically covered within any local agreement, subject to local terms and conditions.

Check on Electrolux Professional website the list of authorized customer care.

C GENERAL SAFETY RULES

C.1 Introduction

The machines are provided with electric and/or mechanical safety devices for protecting workers and the machine itself.

Therefore the user must not remove or tamper with such devices. The Manufacturer declines any liability for damage due to tampering or their non-use.

C.2 Mechanical safety characteristics, hazards

The machine does not have sharp edges or protruding parts. The guards for the moving and live parts are fixed to the cabinet with screws, to prevent accidental access.

C.3 Protection devices installed on the appliance

C.3.1 Guards

The guards on the appliance are:



- fixed guards (e.g. casings, covers, side panels, etc.), fixed to the appliance and/or frame with screws or quick-release connectors that can only be removed or opened with tools;
- interlocked movable guards (door) for access inside the appliance;
- appliance electrical equipment access doors, made from hinged panels openable with tools. The door must not be opened when the appliance is connected to the power supply.



C.3.2 Safety devices

The appliance has:

- interlocks on the front panels giving access to inside the appliance;

C.4 Safety signs to be placed on the appliance or near its area

Prohibition	Meaning
	do not oil, lubricate, repair and adjust moving parts
	do not remove the safety devices
	do not use water to extinguish fires (placed on electrical parts)

Danger	Meaning
	danger of crushing hands
	caution, hot surface
	danger of electrocution (shown on electrical parts with indication of voltage)

C.5 Instructions for use and maintenance

Risks mainly of a mechanical, thermal and electrical nature exist in the appliance. Where possible the risks have been neutralised:

- directly, by means of adequate design solutions.
- indirectly by using guards, protection and safety devices.

Any anomalous situations are signalled on the control panel display.

During maintenance several risks remain, as these could not be eliminated, and must be neutralised by adopting specific measures and precautions.

Do not carry out any checking, cleaning, repair or maintenance operations on moving parts. Workers must be informed of this prohibition by means of clearly visible signs.

To guarantee appliance efficiency and correct operation, periodical maintenance must be carried out according to the instructions given in this manual.

Make sure to periodically check correct operation of all the safety devices and the insulation of electrical cables, which must be replaced if damaged.

C.6 End of use

When the appliance is no longer to be used, make it unusable by removing the mains power supply wiring.

D GENERAL INFORMATION

D.1 Introduction

This manual contains information relevant to various appliances. The product images in this guide are only an example.

The drawings and diagrams given in the manual are not in scale. They supplement the written information with an outline, but are not intended to be a detailed representation of the appliance supplied.

The numerical values given on the appliance installation diagrams refer to measurements in millimeters and/or inches.

D.2 Testing and inspection

Our appliances have been designed and optimized, with laboratory testing, in order to obtain high performance and efficiency.

The appliance is shipped ready for use.

Passing of the tests (visual inspection - electrical test - functional test) is guaranteed and certified by the specific enclosures.

D.3 Definitions

Listed below are the definitions of the main terms used in the manual. It is advisable to read them carefully before use.

Operator	appliance installation, adjustment, use, maintenance, cleaning, repair and transport personnel.
Manufacturer	Electrolux Professional SpA or any other service centre authorised by Electrolux Professional SpA.

Operator for normal appliance use	an operator who has been informed and trained regarding the tasks and hazards involved in normal appliance use.
Customer Care service or specialised personnel	an operator instructed/trained by the Manufacturer and who, based on his professional and specific training, experience and knowledge of the accident-prevention regulations, is able to appraise the operations to be carried out on the appliance and recognise and prevent any risks. His professionalism covers the mechanical, electrotechnical and electronics fields etc.
Danger	source of possible injury or harm to health.
Hazardous situation	any situation where an operator is exposed to one or more hazards.
Risk	a combination of probabilities and risks of injury or harm to health in a hazardous situation.
Protection devices	safety measures consisting of the use of specific technical means (guards and safety devices) for protecting operators against risks.
Guard	an element of a appliance used in a specific way to provide protection by means of a physical barrier.
Safety device	a device (other than a guard) that eliminates or reduces the risk; it can be used alone or in combination with a guard.
Customer	the person who purchased the appliance and/or who manages and uses it (e. g. company, entrepreneur, firm).
Electrocution	an accidental discharge of electric current on a human body.
Emergency stop device	a group of components intended for the emergency stop function; the device is activated with a single action and prevents or reduces damage to persons/appliances/property/animals.

D.4 Machine and Manufacturer's identification data

A reproduction of the marking or dataplate on the machine is given below:

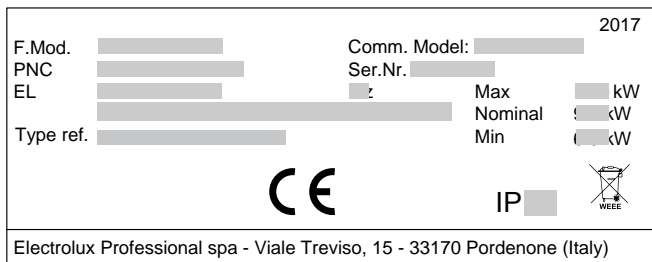

The dataplate gives the product identification and technical data; listed below is the meaning of the various information given on it.

F.Mod.	factory description of product
Comm.Model	commercial description
PNC	production number code
Ser.No.	serial number
400V 3N~	power supply voltage
230V 3 - 230V 1N	electric convertibility (depending on the model)
Hz	power supply frequency
Max – kW	max. power
Nominal – kW	nominal power
IPX4	dust and water protection rating
CE	CE marking
Electrolux Professional SpA Viale Treviso 15 33170 Pordenone Italy	manufacturer

The dataplate is located on the right side panel of the equipment.

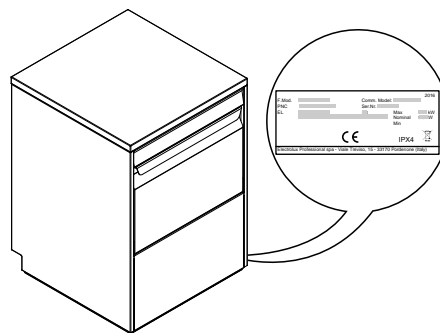

WARNING
Do not remove, tamper with or make the machine marking illegible.

IMPORTANT
When scrapping the machine, the marking must be destroyed.

NOTE!
Refer to the data given on the machine marking for relations with the Manufacturer (e.g. when ordering spare parts, etc.).

D.5 How to interpret the factory description

The factory description on the dataplate has the following meaning (some examples are given below):

(1)	(2)	(3)	(4)	(5)	(6)	(7)	(8)
E	T	UC	L	1	P	1	X
E	T	UC	L	1	P	2	X
E	T	UC	L	3	P		X
E	T	UC	L	1	P	1	

(1) Brand	E = Electrolux Professional, Z = Zanussi, V = Veetsan, N = To brand.
(2) User Interface	T= Touch button
(3) Appliance type	UC = Undercounter
(4) Appliance size	L = Large (cavity height = 440 mm)
(5) Voltage	1 = 220-240V/1N/50Hz 3 = 380-415V/3N/50Hz
(6) Rinsing type	P = Pressure
(7-8) Options	1 = ??????? 2 = ??????? X = ???????

D.6 Type reference

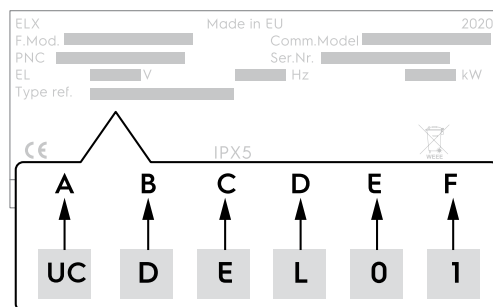

Legend

A	Type of appliance <ul style="list-style-type: none">• UC = Under counter
B	Type of item to wash <ul style="list-style-type: none">• D = Normal tableware
C	Appliance level <ul style="list-style-type: none">• E = Entry
D	Rinsing type <ul style="list-style-type: none">• L = Pressure• P = Rinse pump
E	Boiler heating power <ul style="list-style-type: none">• 0 = 2800 W• 1 = 4500 W
F	Plug type <ul style="list-style-type: none">• 0 = no plug• 1 = Shuko plug (plug type F)• 2 = UK plug (plug type G)

D.7 Responsibility

The Manufacturer declines any liability for damage and malfunctioning caused by:

- non-compliance with the instructions contained in this manual;
- repairs not carried out in a workmanlike fashion, and replacements with parts different from those specified in the spare parts catalogue (the fitting and use of non-original spare parts and accessories can negatively affect appliance operation and invalidates the original manufacturer warranty);
- operations carried out by non-specialised personnel;
- unauthorized modifications or operations;
- missing, lack or inadequate maintenance;
- improper appliance use;
- unforeseeable extraordinary events;

E NORMAL APPLIANCE USE

E.1 Characteristics of personnel enabled to operate on the appliance

The Customer must make sure the personnel for normal appliance use are adequately trained and skilled in their duties. The operator must:

- read and understand the manual;
- receive adequate training and instruction for their duties in order to operate safely;
- receive specific training for correct appliance use.



IMPORTANT

The Customer must make sure his personnel have understood the instructions received and in particular those regarding work hygiene and safety in use of the appliance.

F TECHNICAL DATA

F.1 Main technical characteristics



NOTE!

To locate the dataplate, refer to D.4 *Machine and Manufacturer's identification data*.

Power supply voltage	V	Please refer to dataplate
convertible to		
Frequency	Hz	Please refer to dataplate
Max. power	kW	Please refer to dataplate

- use of the appliance by uninformed and / or untrained personnel;
- non-application of the current provisions in the country of use, concerning safety, hygiene and health in the workplace.

The Manufacturer declines any liability for damage caused by arbitrary modifications and conversions carried out by the user or the Customer.

The employer, workplace manager or service technician are responsible for identifying and choosing adequate and suitable personal protection equipment to be worn by operators, in compliance with regulations in force in the country of use.

The Manufacturer declines any liability for inaccuracies contained in the manual, if due to printing or translation errors.

Any supplements to the installation, use and maintenance manual the Customer receives from the Manufacturer will form an integral part of the manual and therefore must be kept together with it.

D.8 Copyright

This manual is intended solely for consultation by the operator and can only be given to third parties with the permission of Electrolux Professional SpA company.

D.9 Keeping the manual

The manual must be carefully kept for the entire life of the appliance, until scrapping. The manual must stay with the appliance in case of transfer, sale, hire, granting of use or leasing.

D.10 Recipients of the manual

This manual is intended for:

- the employer of appliance users and the workplace manager;
- operators for normal appliance use;
- specialised personnel - Customer Care service (see service manual).

Nominal power	kW	Please refer to dataplate
Min. power	kW	Please refer to dataplate
Power supply cable		H07RN-F
Water supply pressure	kPa [bar]	2 bar [200 kPa] 5 bar [500 kPa]
Water supply temperature:	°C	> 50
Rinse cycle water consumption	l	2 - 2.4
Boiler capacity	l	5
Wash tank capacity	l	20
Water supply hardness for models without incorporated continuous water softener	°f/°d/°e	14/8/10 max
Water supply hardness for models with incorporated water softener		53.4/30/35.7 max
Electric conductivity of water for models without incorporated continuous water softener	µS/cm	<400
Concentration of chlorides in water	ppm	<20
Legal noise level Leq	dB[A]	LpA:68dB-KpA:1.5dB
Protection rating	IP	Please refer to dataplate

G PRODUCT DESCRIPTION

G.1 General description

The appliance is suitable for washing glasses, cups, cutlery. Under no circumstances it can be used for other applications or ways not provided for in this manual.

This equipment has been created in order to ensure a better work environment and cost efficiency.

These appliances are used in restaurants, cafeterias, cooking centers and large institutions. The special dish racks, that can be equipped with various inserts, offer practical and easy use for obtaining excellent washing results.

The electronic system enables complete supervision of the washing process.

G.2 Appliance overview

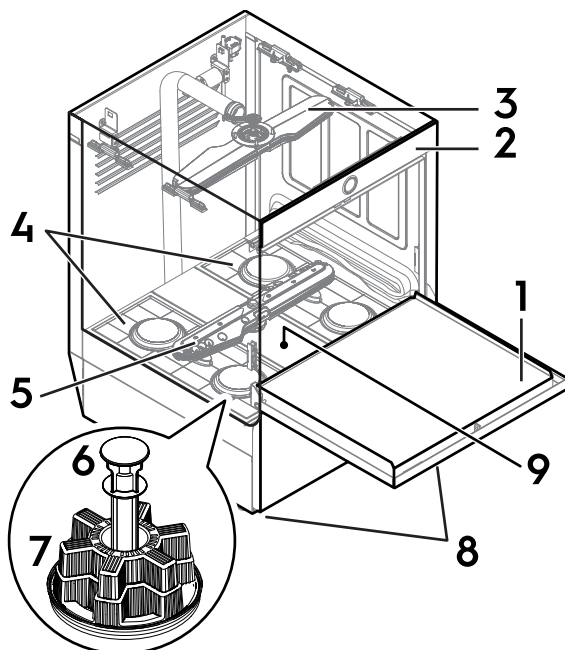

1	Door
2	Control panel
3	Upper wash and rinse arm
4	Tank filters

5	Lower wash and rinse arm
6	Overflow
7	Drain filter
8	Adjustable feet
9	Central support

G.3 Type of racks and loading

i NOTE!
Not all these racks are available for each model.

- YELLOW rack: for 18 plates with maximum diameter of 240 mm.

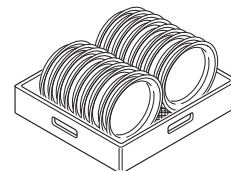

- GREEN rack: for 12 bowls with maximum diameter of 240 mm.

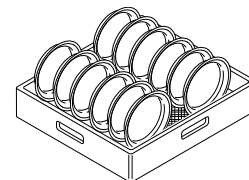

- BLUE rack for glasses: the glasses should be placed upside down.

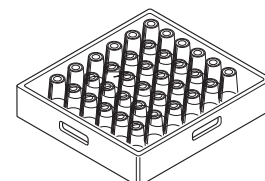

- YELLOW container for cutlery: insert items, with the handles pointing downwards, in each container.

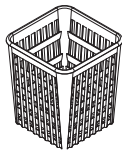

- Half size basket - universal (500 x 250 mm)

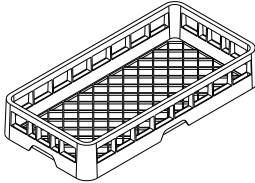

- Half-size basket for plates (500 x 250 mm)

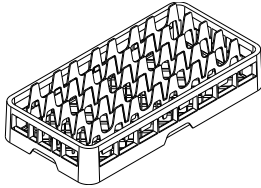

- Half size basket for glasses (500 x 250 mm)

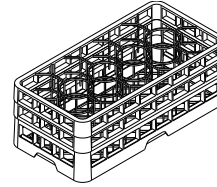

Available as accessories: dividers for glasses and rack for dishes with maximum diameter of 320 mm.



IMPORTANT

If only one type of dish rack is to be used, it is advisable to choose the GREEN rack.

H CONTROL PANEL DESCRIPTION

H.1 Control panel

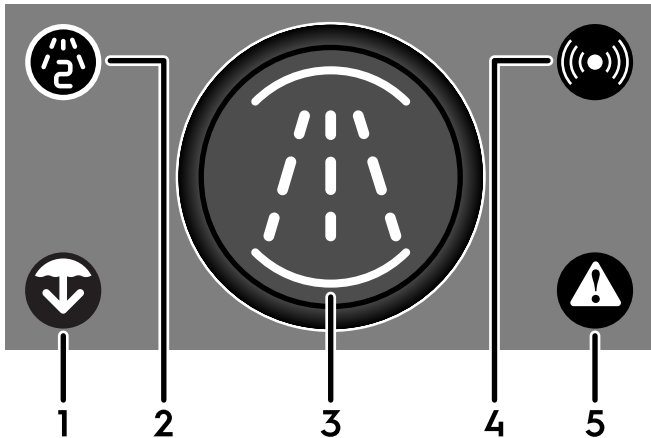

1	Drain/self-cleaning icon
2	Secondary wash cycle icon
3	Control button
4	Connectivity icon
5	Warning/Alarm icon

H.2 Basic control

H.2.1 Drain/self-cleaning icon



IMPORTANT

Make sure to remove the overflow before to start the drain/self-cleaning cycle.

This icon  lights up in white when the drain/self-cleaning cycle is active.

With the appliance ready to use, touch and hold the control button **3** for 2 seconds to start the drain/self-cleaning cycle.



NOTE!

By default, during the shutdown, the appliance starts the drain/self-cleaning cycle.

Icon status

Icon blinks in yellow. ¹	The appliance suggest you to execute a drain/self-cleaning cycle (available soon).
Icon is on in white.	Drain/self-cleaning cycle is running.

1. It is not mandatory. If the user does not start drain/self-cleaning cycle, after some time, the icon stops to blink.

Switch the appliance off WITHOUT complete the drain/self cleaning cycle

1. Close the door.
2. With the appliance ready to use, touch and hold the control button **3** for 2 seconds to start the drain/self-cleaning cycle.

The icon  is on in white to confirm that the drain/self-cleaning cycle is in progress.

3. When the cycle starts, touch and hold again the control button **3** for 2 seconds to stop the drain/self-cleaning cycle and switch the appliance off.

H.2.2 Secondary wash cycle icon

This icon  lights up when the secondary wash cycle is enabled.



NOTE!

Secondary wash cycle is now enabled for all next wash cycles.

H.2.3 Control button

Touch the control button for 2 seconds to switch the appliance on. The buzzer sounds.

The different colours of the control button (orange, green, light blue and purple) correspond to different status of the appliance.



Control button colours

Control button is off.	The appliance is off.
Control button is off and the Alarm/Warning icon is on in red.	The appliance is in alarm or warning status. Refer to P.1 <i>Anomaly details</i> how to fix it.

Control button colours (cont'd.)

Control button is orange. ¹	The appliance is on and in warm-up status. The warm-up is the state in which the appliance fills the water in the wash tank and in the boiler.
Control button blinks in orange.	The door is opened during the warm up.
Control button pulses in orange.	In this state, the appliance stops to fill water and continues the heating phase. ²
Control button is steady green.	The appliance is ready for use.
Control button is light blue.	The washing cycle is working.
Control button blinks in light blue.	The door is opened during the washing cycle.
Control button is flashing green.	The washing cycle is finished.
Control button is purple.	Manual activation of the detergent dispensers.

1. The control button is in orange during the entire filling stage.
2. It is possible starts to wash but with low washing performances.

H.2.4 Connectivity icon

This icon  lights up to indicate that the appliance is connected to smartphone application or cloud environment.

Icon status colours

Icon is light blue.	The smartphone application "AppOne" and the appliance have established a bluetooth connection.
Icon blinks in white.	The smartphone application "AppOne" and the appliance is establishing a remote connection to cloud (available soon).
Icon is white.	The remote connection to cloud is active (available soon).



NOTE!
For the remote control activation, you must touch the "Control button" to approve the connection.

H.2.5 Alarm/Warning icon

This icon  lights up when some kind of problem occurs. The buzzer sounds.

Icon status colours

Icon is on in yellow.	Warning icon. The error does not block the appliance. The user can continue to use the appliance.
Icon blinks in red while the buzzer sounds. After few seconds icon is on.	Alarm icon. The error blocks the appliance. The user must switch the appliance off and call the service centre.



NOTE!
Open the smartphone application "AppOne", touch the Alerts tab to see Alarm/Warning notification (refer to P.1 *Anomaly details*).

I APP CONNECTION

I.1 Intro



IMPORTANT

- Minimum requirements for your smartphone:
- Android operating system: 8.0 Oreo
 - Apple iOS: 16.4

To use all functionalities of your appliance it is necessary download and install on a smartphone device the "AppOne" application available on Google Play and Apple Store (available soon).

After preliminary contact with the technical department, you will receive in your mail account an invitation mail from "One-Connected-Dev" with a link to complete the registration and execute the first access.

Read the mail and click the attached link directly from your smartphone.

Use this smartphone application to receive useful information about:

- factory code;
- serial number.
- appliance overview (live status);
- alerts;
- settings;

- priming of detergents.

I.2 Register into One Connected

1. Open your mail application and find the below mail.



▶ **one-connected-dev**

Welcome into One Connected - In...

Dear user, Welcome into One Co... ★

- Open the mail and click on the button to accept the invitation.

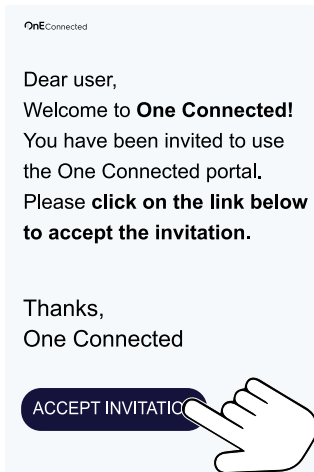

- Check and complete the registration.

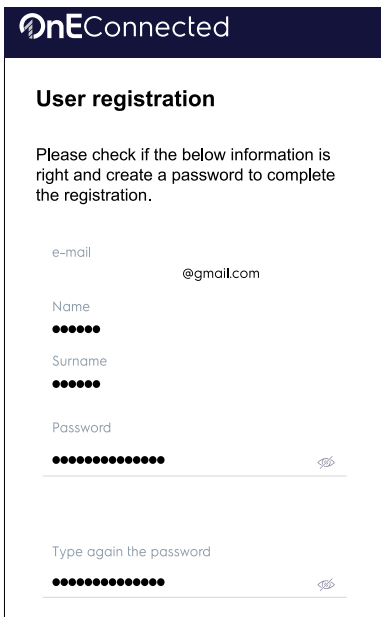

IMPORTANT
Keep your password in a safe place for additional reference.

I.3 Download “AppOne” application

- With the camera of your smartphone scans the QR-Code that you can find in the front cover of the quick guide.
- From the open web page, download and install “AppOne” application.

NOTE!
Make sure to choose correct link corresponding your smartphone operating system.

I.4 Login “AppOne” application with authentication (first use)

IMPORTANT
Make sure to enable **bluetooth** and **geo-location** connections on your smartphone and switch the appliance on.

- Touch on “AppOne” icon to open the application.



- Insert your credentials (email address and password) to authenticate your account (refer to I.2 Register into One Connected).

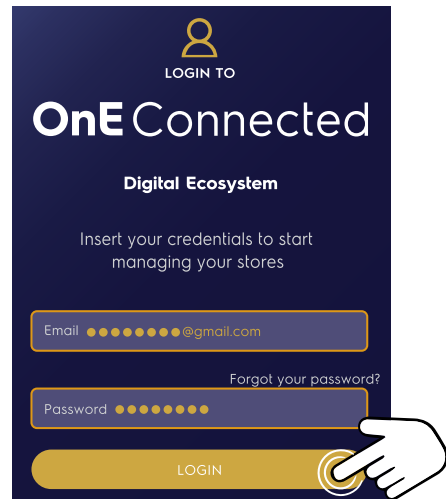

- At the end of login phase a message appears to remember you to enable bluetooth and geolocation connection before to continue.

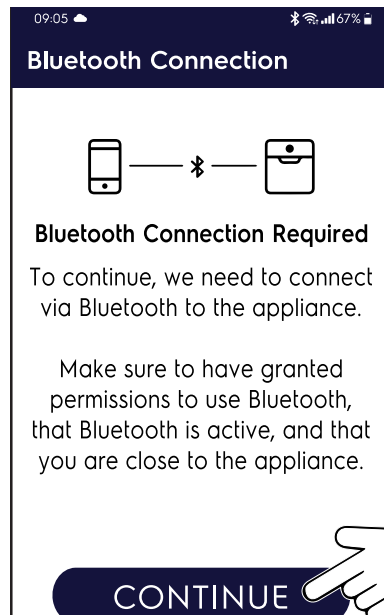

- Accept all permission requests from “AppOne” application (bluetooth and geolocation).

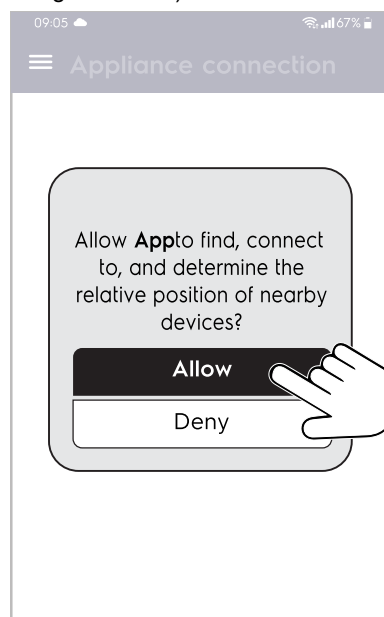

5. Touch "SEARCH NEARBY DEVICES" button to find the appliance. After a few seconds, the display shows the appliance that you have to connect.



NOTE!

If you are not able to see any appliance, touch "SEARCH NEARBY DEVICES" button again. Otherwise, close and open again "AppOne" application and start again the search of appliance.

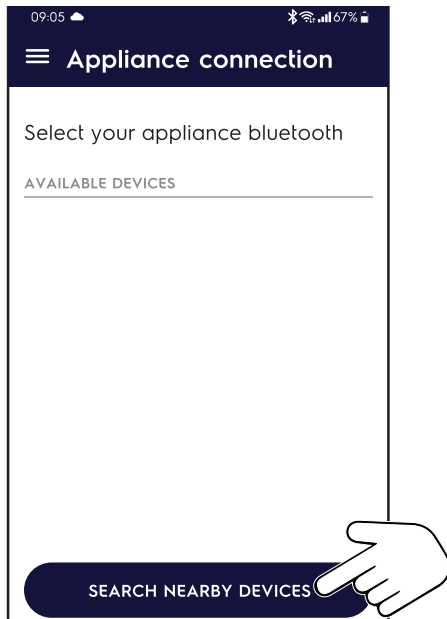

6. If the Bluetooth Connection is not active, the below message informs the user how to enable the Bluetooth connection (user must give the application permission to activate Bluetooth connectivity).

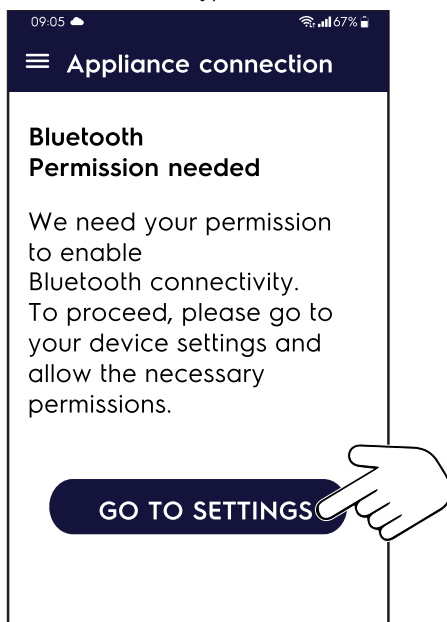

7. Find the proper appliance from the possible list and touch the button "CONNECT" to connect the appliance with the smartphone application.

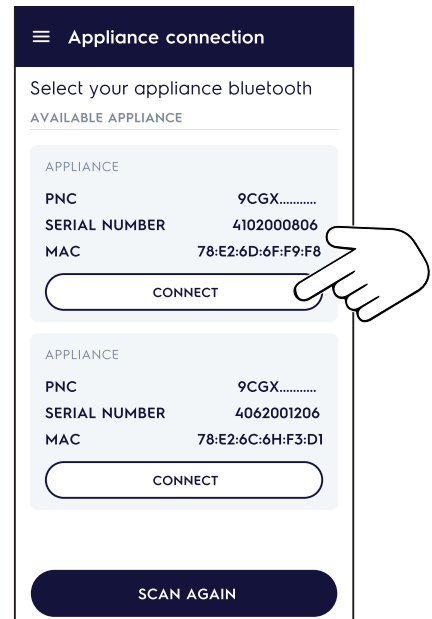

8. At the end of pairing operation, to verify the success of the operation, check if the connection is now active (refer detail 1) and the corresponding button changes from "CONNECT" to "DISCONNECT" (refer detail 2).

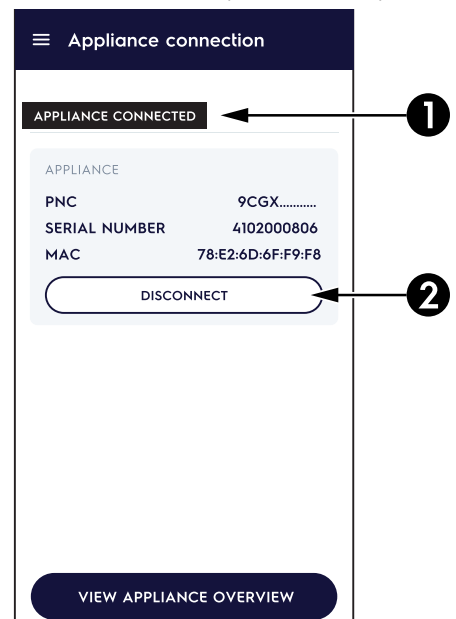

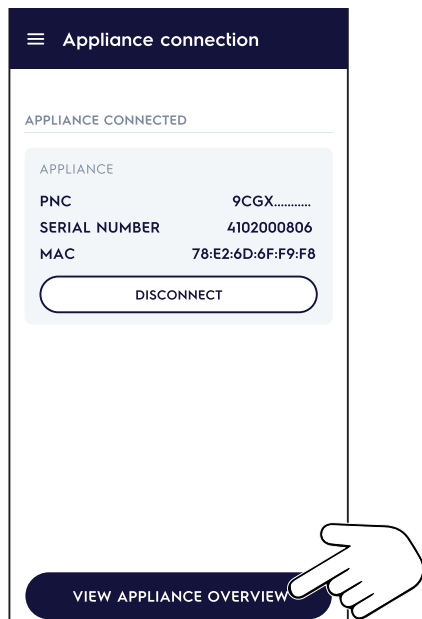

9. Touch the button in the lower part of the display, to view the **“LIVE STATUS”** of the appliance.
For additional information about **“LIVE STATUS”** refer to L.7 *Check the appliance status by “AppOne” application.*



I.5 Login “AppOne” after authentication



IMPORTANT

Make sure to enable **bluetooth**  and **geo-location**  connections on your smartphone and switch the appliance on.

1. Touch on **“AppOne”** icon to open the application.



2. Refer to point 5. to 9. from I.4 *Login “AppOne” application with authentication (first use)* paragraph to connect the appliance.

J PRIMING OF DETERGENTS

J.1 Detergent dispensers activation



NOTE!

When the detergent containers are replaced, it may be necessary to activate the dispensers manually in order to fill the hoses and eliminate any air.

J.1.1 Manual activation by control panel

1. Touch the control button for 2 seconds to switch the appliance on.
2. If necessary, wait the end of warm-up status (control button in orange).
3. With the control button in green (the appliance is ready for use.), open the door.

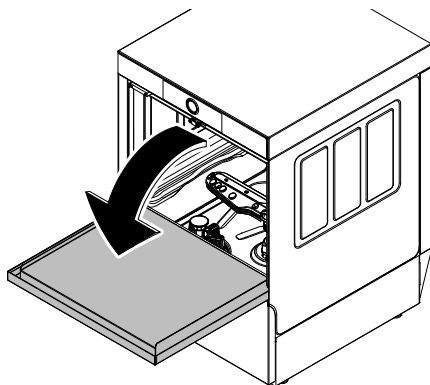

4. Touch and hold the control button for 5 seconds.

5. The buzzer sounds to confirm the request to activate both dispensers.

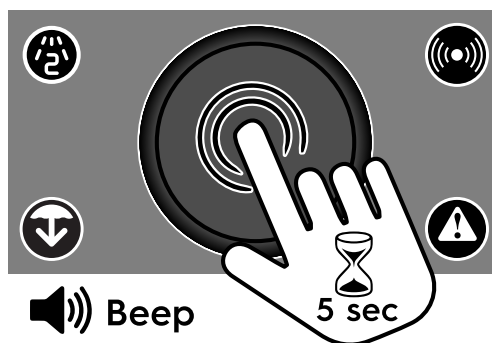

IMPORTANT

The control button is now in purple till the end of detergent dispensers activation.

At the end of detergent dispensers activation, the control button comes back in green.

6. To cancel the current request, touch the control button again for 2 seconds.
7. If the detergent hoses do not enough fill, repeat steps 3 to 5 to activate again the detergent dispensers.

J.1.2 Activation by “AppOne” application



NOTE!

Only when the appliance is in ready to use, it is possible activate priming phase by **“AppOne”** application.

1. Touch on **“AppOne”** icon to open the application.



2. Touch the  icon to open the main menu.

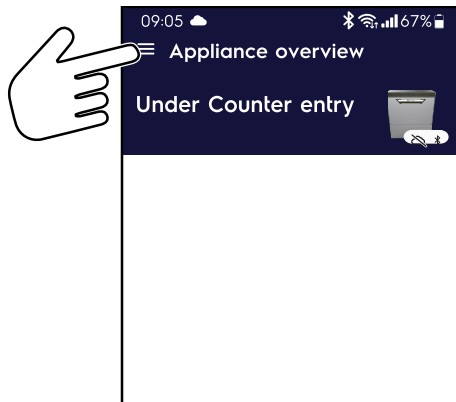

3. From main menu, touch the **“Settings”** tab.

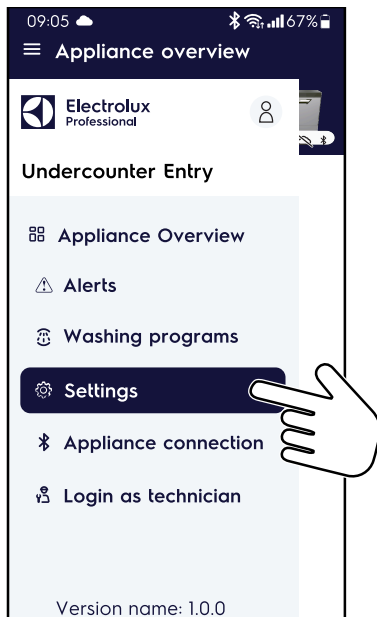

4. From **“Settings”** menu, touch **“Priming”** tab.

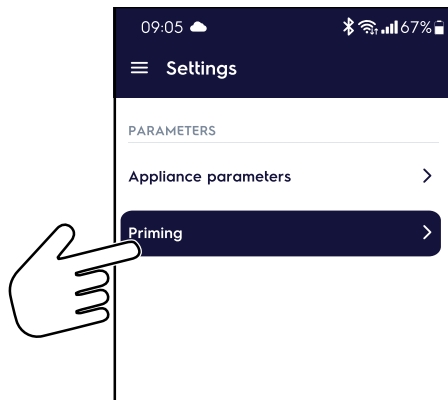

5. To activate detergent or rinse aid pump touch the corresponding start icon .

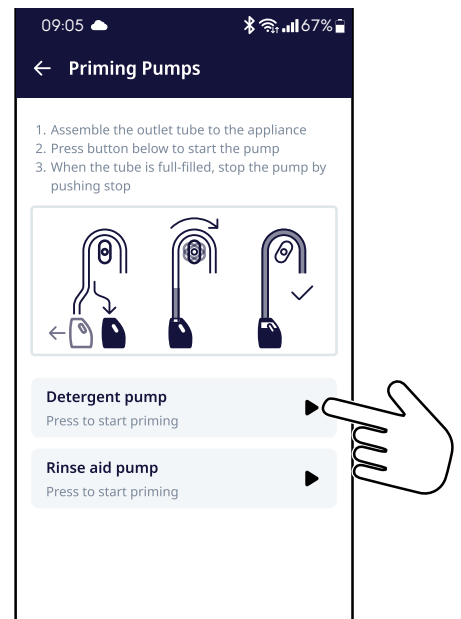

6. The circular progress indicator  starts to run and the buzzer sounds to indicate the start of the operation.



NOTE!

A pop-up message appears on the display to confirm the completion of the operation.

7. To interrupt the operation touch the stop icon .

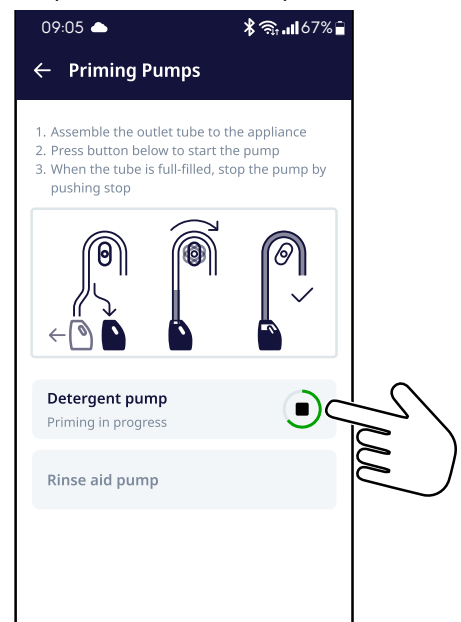

K DISPENSERS SETTING

K.1 Dispenser parameters



NOTE!

You can change default parameters ONLY by **“AppOne”** application.

- Switch the appliance on.
- Open the door.
- Do not select any wash cycle.
- Touch on **“AppOne”** icon to open the application.
- Touch the  icon to open the main menu.

- From main menu, touch the **“Settings”** tab.

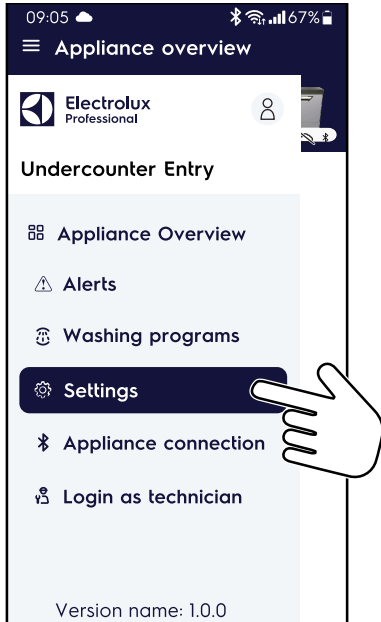

- Modify the factory value and touch **“Done”** button.

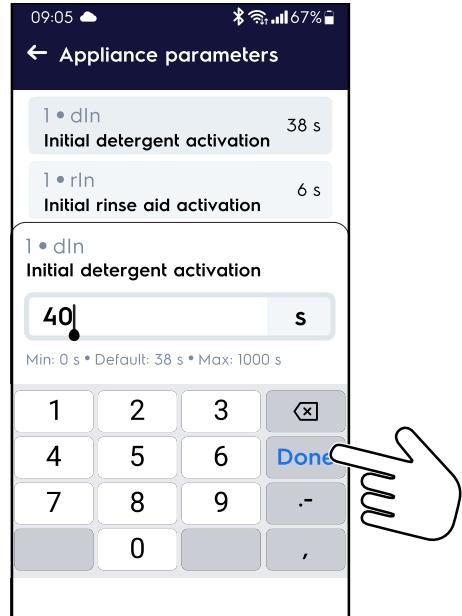

- From **“Settings”** menu, touch **“Appliance parameters”** tab.

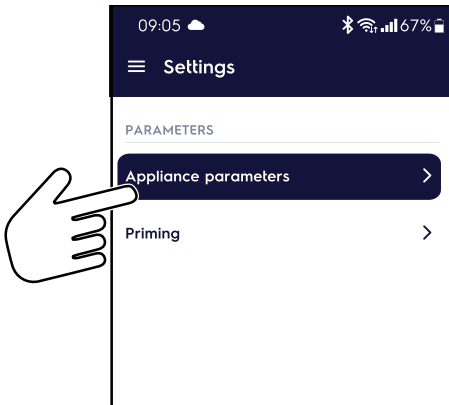

- The updated parameter is now put in evidence by a dark grey row. Touch **“Save”** button to confirm the change.

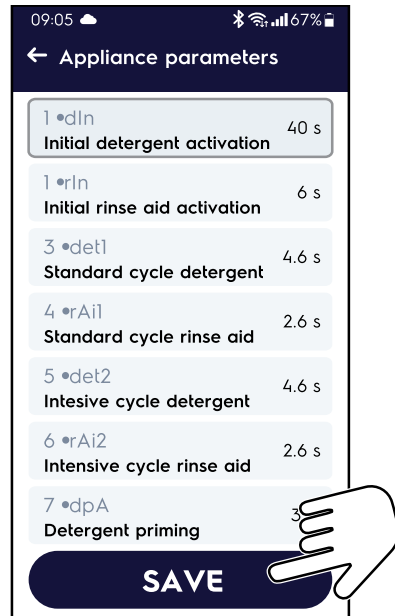

K.2 Change a parameter value

- From the list of parameters, find the requested parameters and touch it.

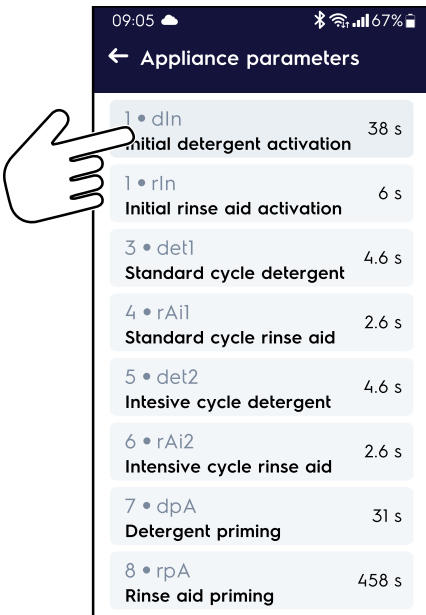

K.3 Detergent and rinse aid parameters list

Parameter name	Parameter description	Factory set
1 dIn Initial detergent activation	Activation time of the detergent dispenser during the filling of the tank.	38 seconds
2 rIn Initial rinse aid activation	Activation time of the rinse aid dispenser during the filling of the boiler. It starts at the end of filling tank phase.	6 seconds
3 det1 "Standard" cycle detergent	Activation time of the detergent dispenser during the wash cycle of the "Standard" programme.	4.6 seconds
4 rAi1 "Standard" cycle rinse aid	Activation time of the rinse aid dispenser during the rinse phase of the "Standard" programme.	2.6 seconds
5 det2 "Intensive" cycle detergent	Activation time of the detergent dispenser during the wash cycle of the "Intensive" programme.	4.6 seconds
6 rAi2 "Intensive" cycle rinse aid	Activation time of the rinse aid dispenser during the rinse phase of the "Intensive" programme.	2.6 seconds
7 dpA Detergent priming	Activation time of the detergent dispenser during the "Priming" phase.	31 seconds
8 rpA Rinse aid priming	Activation time of the rinse aid dispenser during the "Priming" phase.	458 seconds

L USE

L.1 Starting



IMPORTANT

On the first start after installation, make sure to carry out a couple of cycles without dishes to flush out any industrial grease which has remained in the tank and piping.

Basic operations

- Open the water supply tap.
- Switch on at the mains.
- Open the door and check that all the components are in their correct position (refer to M.3 *End of service*):
 - drain filter of the wash tank;
 - overflow;
 - tank filters;
 - wash and rinse arms.
- Touch the control button for 2 seconds to switch the appliance on. The buzzer sounds.
- The different colours (orange, green and light blue) of the control button corresponds to different status of the appliance.

Control button colours



Control button is off.	The appliance is off.
Control button is off and the Alarm/Warning icon is on in red.	The appliance is in alarm or warning status. Refer to P.1 <i>Anomaly details</i> how to fix it.
Control button is orange. ¹	The appliance is on and in warm-up status. The warm-up is the state in which the appliance fills the water in the wash tank and in the boiler.
Control button blinks in orange.	The door is opened during the warm up.
Control button pulses in orange.	In this state, the appliance stops to fill water and continues the heating phase. ²
Control button is steady green.	The appliance is ready for use.
Control button is light blue.	The washing cycle is working.

Control button colours (cont'd.)

Control button blinks in light blue.	The door is opened during the washing cycle.
Control button is flashing green.	The washing cycle is finished.
Control button is purple.	Manual activation of the detergent dispensers.

1. The control button is in orange during the entire filling stage.
2. It is possible starts to wash but with low washing performances.



NOTE!

During the warm-up, you can open the "AppOne" application in your smartphone to get in real time the status of the appliance (refer to L.7 *Check the appliance status by "AppOne" application*).

L.2 Loading dishes on racks

The appliance is suitable for washing dishes, glasses, cups, cutlery, containers and receptacles in plastic and/or steel used for preparing, cooking and serving; as well as a wide variety of ceramic and/or metal cooking utensils. However it is advisable not to wash decorated dishes or place silverware in contact with other metals.



IMPORTANT

The appliance does not remove burnt food deposits from dishes. Dishes with burnt-on food deposits should be cleaned mechanically/chemically before putting them in the dishwasher. Before inserting the racks in the machine, clear the dishes of any food residuals and rinse them with cold or warm water, at a max. temperature of 35°C [95°F], using a manual prewash spray.

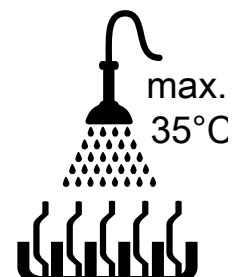

**CAUTION**

Failure to remove the residuals of detergent possibly used for manual prewash can cause malfunctioning of the dishwasher and compromise washing results.

**IMPORTANT**

This machine must only be used for washing dishes, containers, etc. (see above) do not use it to wash animals or food (e.g., fruit, vegetables, meat or fish).

L.3 Operation**IMPORTANT**

- If the appliance is stopped or the door is opened for a long time, wash at least 3 empty racks. This allows all the appliance to reach the working temperature.

When the control button is green, the appliance is ready for use.

1. Open the door.
2. Insert the rack containing the dirty tableware.
3. Close the door and touch the control button to start the washing cycle.
The colour of the control button change from green to light blue.
4. To stop the wash cycle, just press the control button or open the door.
5. To continue the wash cycle, press the control button again or close the door. The cycle starts again from where it was stopped.
6. At the end of the wash cycle, the buzzer sounds and the control button blinks in green.
7. Open the door and remove the rack containing the clean tableware.

**CAUTION**

The use of “foaming/nonspecific” detergents or in any case detergents used in different ways from that prescribed by the manufacturer, can cause damage to the dishwasher and compromise the washing results.

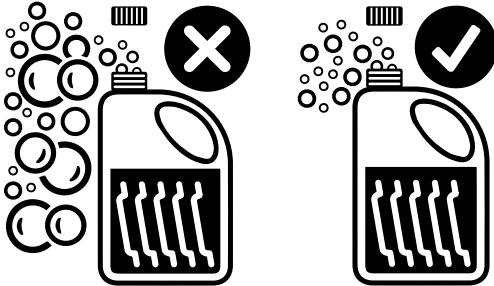
**NOTE!**

To obtain excellence washing performance, use detergent, rinse aid and descaling agent suggested by Electrolux Professional. In the Electrolux Professional web site, open the “Accessories and Consumables” web page and navigate into the dishwashing equipment tab to order most suitable detergents and accessories.

L.4 Wash cycles

Standard cycle time with supply water 50°C

Wash cycle	Type of soil	Estimated duration ¹
STANDARD ²	Normal soil Glasses	100 sec
INTENSIVE ³	Heavy soil	150 sec

1. A device lengthens the cycle time if the water in the boiler has not reached the minimum temperature for correct rinsing.
2. This wash cycle is usually linked to the control button.
3. This wash cycle is usually linked to secondary cycle.

**CAUTION**

Only a specialised personnel can modify wash cycle parameters.

L.5 View wash cycles details

1. Touch on “AppOne” icon to open the application.



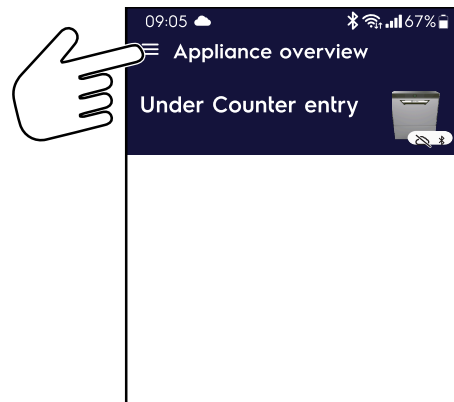

2. From main screen, touch the to open the main menu.

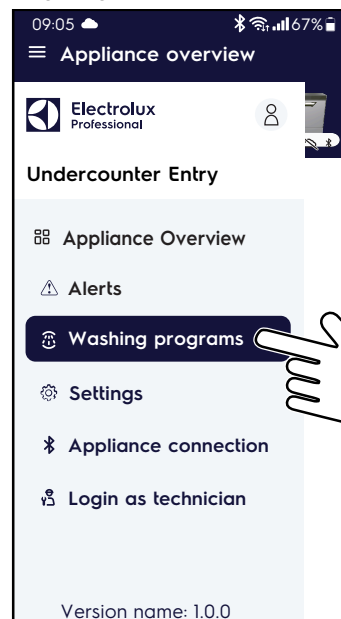

3. Touch “Washing programs” tab to see the list of available washing programmes.



4. Active wash cycles:

-  **STANDARD** (as a primary wash cycle).
-  **INTENSIVE** (as a secondary wash cycle).

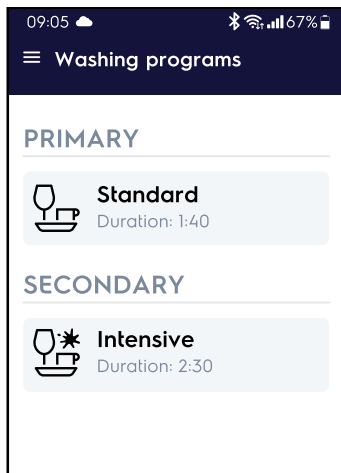

5. Touch on **STANDARD** or **INTENSIVE** tab to see the program details.

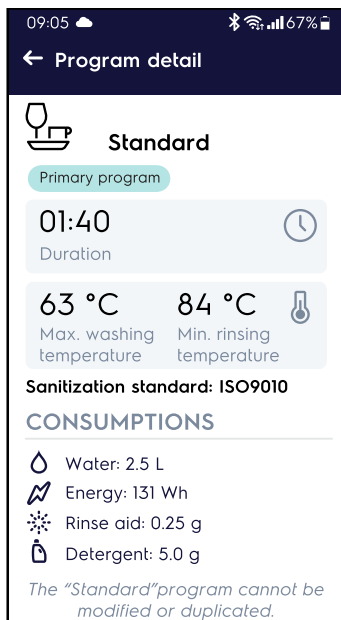

L.6 Enable or disable secondary cycle

Enable

With the appliance switched on:

1. open the door;
2. touch the control button;
3. the icon  is on to confirm that secondary wash cycle is now enabled;
4. insert the rack with tableware, touch control button to start the secondary wash cycle.



NOTE!

Secondary wash cycle is now enabled for all next wash cycles even if you switch off the appliance.

Disable

With the appliance switched on:

1. open the door;
2. touch the control button;
3. the icon  is off to confirm that secondary wash cycle is now disable;
4. insert the rack with tableware, touch control button to start the primary wash cycle.

L.7 Check the appliance status by “AppOne” application

- Touch on “**AppOne**” icon to open the application.



- Touch the  icon to open the main menu.

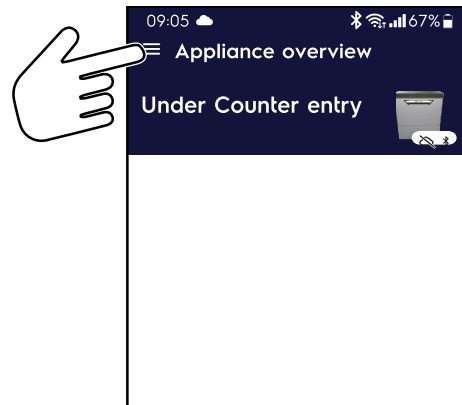

- From main menu, touch the “Appliance Overview” tab.

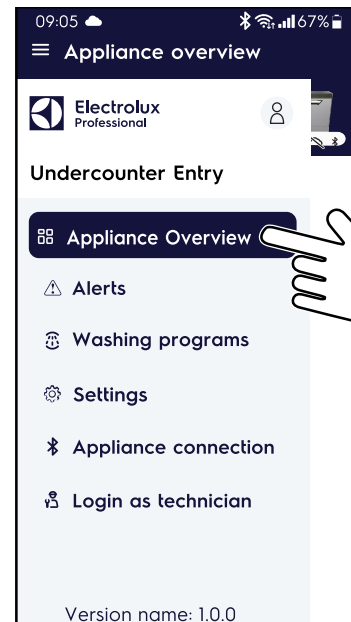

- Check the “LIVE STATUS” of the appliance.

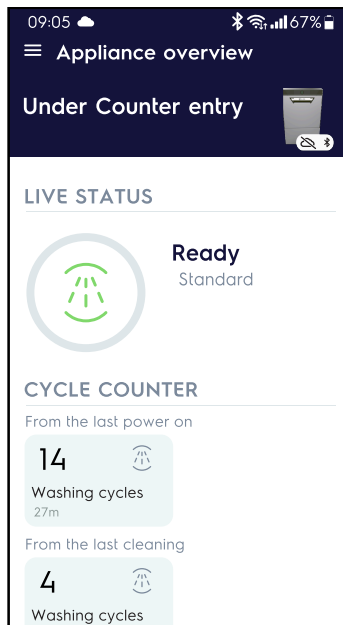

LIVE STATUS list

Icon	Appliance status	Short description
	Warm up	The appliance starts: <ul style="list-style-type: none"> • the filling and heating phase of the water; • remaining time to the end of warm up by the animated round bar.
	Ready Low temperature	The appliance: <ul style="list-style-type: none"> • stops the filling phase and continue the heating phase of the water;
	Ready	The appliance has finished the heating phase and now is ready to work. The application shows: <ul style="list-style-type: none"> • wash cycle name; • possibly anomalies.

LIVE STATUS list (cont'd.)

Icon	Appliance status	Short description
	Washing	The wash cycle is running. The application shows: <ul style="list-style-type: none"> • wash cycle name; • wash tank temperature; • rinse temperature; • remaining time to the end of wash cycle by the animated round bar; • cycle counters updated; • possibly anomalies.
	Wash cycle completed	End of the wash cycle. The application shows: <ul style="list-style-type: none"> • wash cycle name; • cycle counters updated; • possibly anomalies.
	Cleaning	The Drain/self-cleaning cycle is running. The application shows: <ul style="list-style-type: none"> • cycle name; • remaining time to the end of cleaning cycle by the animated round bar; • cycle counters updated; • possibly anomalies.
	Alarm (red icon) or Warning (yellow icon)	In the appliance there is an anomaly. The application shows: <ul style="list-style-type: none"> • anomaly status: <ul style="list-style-type: none"> – active; – solved. • Anomaly type: <ul style="list-style-type: none"> – Alarm. – Warning. • Anomaly code and name: <ul style="list-style-type: none"> – Alarm blocks the appliance. – Warning does not block the appliance.

M APPLIANCE CLEANING



WARNING

Refer to “**WARNING AND SAFETY INFORMATION**”.

M.1 Care information

Care operations have to be carried out by the owner and/or user of the appliance.



IMPORTANT

Problems resulting from poor or lack of care as hereinafter described will not be covered by the warranty.

M.2 Cleaning introduction

In order to reduce the environmental impact of pollutants it is advisable to clean the appliance (externally and, where necessary, internally) with products that are more than 90% biodegradable.

Use lukewarm water, a neutral detergent/cleaner if necessary, and a soft brush or sponge. If another type of detergent is used,

carefully follow the producer's instructions and observe the safety rules given in the information sheets provided with the product or substance.

Rinse and dry thoroughly.



CAUTION

- Do not use solvent-based detergents (e. g. trichloro-ethylene) or abrasive powders for cleaning.
- Do not use steel brushes, steel wool, copper cloths, sand-based or similar products for cleaning.



WARNING

When using chemicals, comply with the safety notes and dosage recommendations printed on the packaging. Refer to the chapter *A.2 Personal protection equipment* for handling chemical products.



M.3 End of service



NOTE!

The appliance is designed to carry out an automatic cleaning cycle to help flush out any residues and to guarantee greater health and hygiene.

M.3.1 Start the drain/self-cleaning cycle

1. Open the door and take out the rack containing the clean tableware.
2. Remove the tank filters "C" (depending on the models).

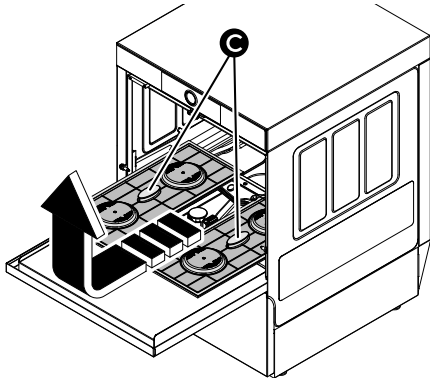

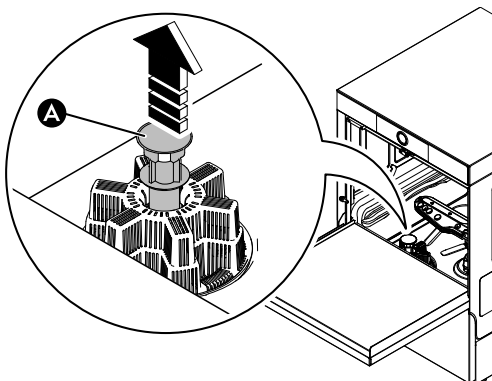

3. Remove the overflow "A".



4. Close the door.

With the control button in green, start the drain/self-cleaning cycle by pressing control button for 2 seconds.

The icon  is on in white to confirm that the drain/self-cleaning cycle is in progress.

5. After a few minutes, the buzzer sounds and the icon  is off to indicate the end of the cleaning cycle and the appliance switches off automatically.

M.3.2 Clean wash tanks components



IMPORTANT

Carefully clean all the parts with a water jet and neutral detergent/deterative, if necessary using a soft brush or sponge.

1. Switch off at the mains.

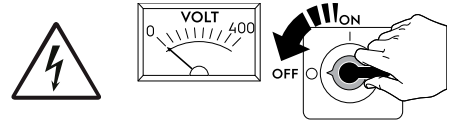

2. Close the water supply tap.

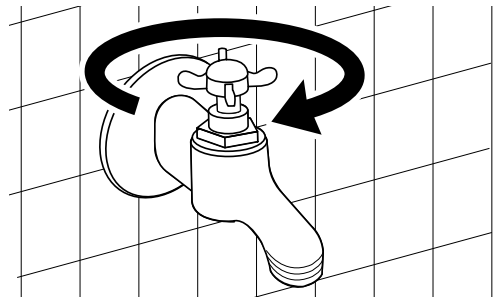

3. Remove and clean the tank filters "C" (depending on the model).

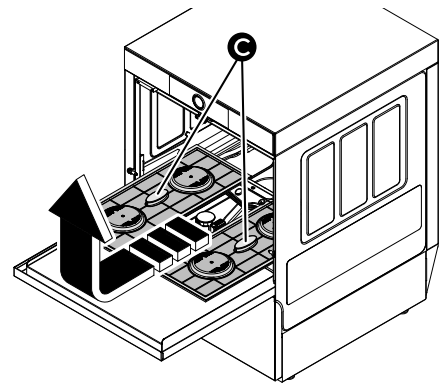

4. Remove and clean the upper and lower wash and rinse arms.

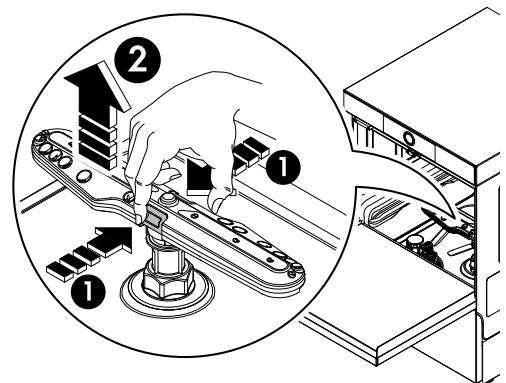

CAUTION

Do not use sharp implements to clean the nozzle holes, which could otherwise be damaged.

5. Remove and clean the central support (depending on the model).

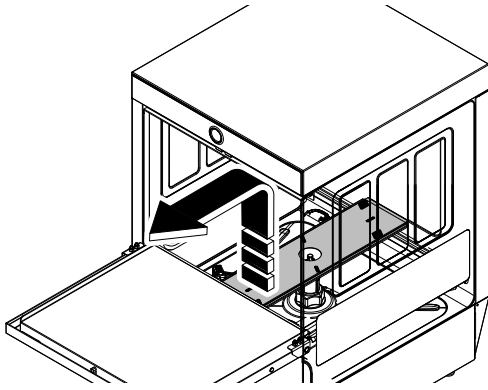

6. Remove the drain filter of the wash tank "B" and clean away any remained food in order to avoid blocking the draining system.

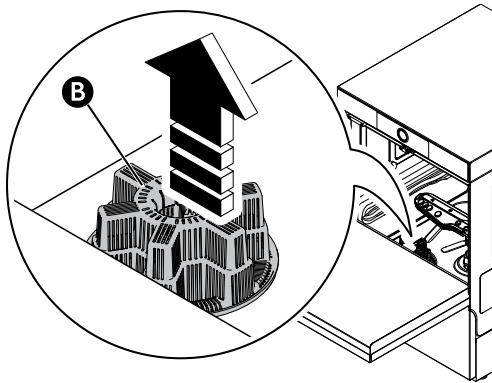

7. Upon completion of cleaning operations, replace the parts removed previously;
- drain filter "B";
 - overflow "A";
 - central support
 - upper and lower wash and rinse arms.
 - tank filters "C";



CAUTION

Make sure to refit properly all components.

N APPLIANCE MAINTENANCE

N.1 Maintenance frequency

To ensure constant appliance efficiency, it is advisable to carry out the checks with the frequency given in the following table:

Maintenance, inspections, checks and cleaning	Fre-quency	Respon-sibility
Ordinary cleaning • general cleaning of appliance and surrounding area	Daily	Operator
Ordinary cleaning • Every month descale the wash and rinse jets with vinegar.	Monthly	Operator
Ordinary cleaning • Every month descale the wash and rinse jets with scale remover.	Monthly	Service
Mechanical protection devices • check their condition and for any deformation, loosening or removed parts	Monthly	Service
Control • check the mechanical part, for cracks or deformation, tightening of screws: check the readability and condition of words, stickers and symbols and restore if necessary	Yearly	Service
Appliance structure • Descale the boiler, inside surfaces of the tank and the appliance piping.	Yearly	Service

Maintenance, inspections, checks and cleaning	Fre-quency	Respon-sibility
Appliance structure • The internal hose of the rinse-aid and detergent peristaltic dispenser should undergo periodic maintenance.	Yearly	Service
Appliance structure • If present, clean the finned coil of the energy saving device.	Yearly	Service
Appliance structure • tightening of main bolts (screws, fixing systems, etc.) of appliance	Yearly	Service
Safety signs • check the readability and condition of safety signs	Yearly	Service
Electrical control panel • check the electrical components installed inside the electrical control panel. Check the wiring between the electrical panel and appliance parts.	Yearly	Service
Electrical connection cable and plug • check the connection cable (replace if necessary) and plug	Yearly	Service
General appliance overhaul • check all components, electrical equipment, corrosion, pipes...	Every 10 years ¹	Service

1. the appliance is designed and built for a duration of about 10 years. After this period of time (from commissioning) the appliance must undergo a general inspection and overhaul. Some examples of checks to be carried out are given below.

N.2 Periods of non-use

If the appliance is not going to be used for some time, take the following precautions:

- close the water supply tap(s), if present;
- disconnect the power supply or remove the plug from the power socket, if present;
- completely drain the tank(s);
- remove and carefully clean the filters;
- completely drain the boiler;
- completely drain the incorporated dispenser hoses. Remove them from the containers;
- carefully clean the internal parts of the appliance;
- clean the cabinet, going over all the stainless steel surfaces vigorously with a rag moistened with paraffin oil to create a protective film;
- leave the door or drawers, if present, open so that air can circulate inside, preventing the formation of unpleasant odours;
- periodically air the premises.



IMPORTANT

The warranty does not cover any damages caused by ice formations in the appliance pipes.

N.3 Machine disposal

At the end of the product's life cycle, make sure the equipment is not dispersed in the environment. The equipment must be disposed of in compliance with current regulations in the country of use.

All metal parts are in stainless steel (AISI 304) and removable. Plastic parts are marked with the letters of the material.



The symbol on the product indicates that this product should not be treated as domestic waste, but must be correctly disposed of in order to prevent possible negative consequences for the environment and the human health.

Regarding the recycling of this product, please contact the sales agent or dealer of your product, your Customer Care service or the appropriate waste disposal service.

Risk of fire or explosion. Flammable refrigerant used

O TROUBLESHOOTING

O.1 General troubleshooting

Anomaly	Type of anomaly	Possible causes	Actions
The dishwasher does not switch on	Blocking	The dishwasher is not connected to the main power supply.	Check if the appliance main circuit breaker is in ON position.
The dishwasher does not start	Blocking	The door is open.	Close the door. If the error persists call service centre.
You start the washing cycle but the dishwasher does not work.	Blocking	Control interface faulty.	Switch off and on the appliance. If the error persists call service centre.
The dishwasher does not wash well.	Loss of performance.	No scrape action before putting dishes in the racks	Scrape dishes before putting them in the racks.
		The wash arms are clogged by solid food remains. Residual food has not been removed from dishes.	Check if the wash jets are clogged by solid food remains.
		The wash arms are not properly installed.	Check the integrity of the wash arms. Remove and fit again the wash arms.
		The dishes are not correctly placed in the racks.	Check if the dishes are correctly placed in the racks.
		The dosing of detergent is not correct.	Call detergent and rinse aid service centre.
		The detergent tank is empty.	Check that there is detergent in the container and if necessary top it up.
		Detergent pump does not work.	Switch off and on the appliance. If the error persists call service centre.
Glasses and dishes are not dried properly.	Loss of performance.	The wash tank suction filter is dirty.	Clean wash tank suction filter thoroughly.
		The container of rinse aid is empty.	Check that there is rinse-aid in the container and if necessary top it up.
		Rinse aid pump does not work.	Switch off and on the appliance. If the error persists call service centre.
		The rinse water temperature is too low.	Check if the rinse water temperature is between 82°C - 90°C. Call service centre to set the temperature in according to the rinse aid specifications.
		Foamy detergent present in the wash tank.	Check if the dishes were not immersed in foamy detergent (e.g. hand wash detergent) before being put in the dishwasher. Only use "non-foaming" products for professional dishwashers.

Anomaly	Type of anomaly	Possible causes	Actions
Condensation on glasses.	Loss performance.	The container of rinse aid is empty.	Check that there is rinse-aid in the container and if necessary top up.
		Rinse aid pump does not work.	Switch off and on the appliance. If the error persists call service centre.
Stains on the glasses.	Loss of performance.	Foamy detergent present in the wash tank.	Only use "non-foaming" products for professional dishwashers.
		The dosing of rinse aid is not correct.	Call service centre.
		The hardness of the water is too high or too low.	Call service centre to adjust the amount of detergent and rinse aid.
Excessive foam in the tank.	Loss performance.	Residuals of food or detergent, used for manual prewash, remains in the dishes.	Remove residuals of food or detergent from the dishes.
		Wash water temperature is too low.	Check if the water temperature of the wash tank is between 55°C - 65°C. Call service centre to set the temperature in according to the detergent specifications.
		Foamy detergent present in the wash tank.	Empty and refill the tank with water until the foam has been removed.
Smears or spots on the glasses.		Too much rinse-aid.	Call service centre to reduce the amount of rinse-aid.
Low pressure from wash arms.	Loss of performance	The tank filter is clogged. The wash pump filter is clogged. The water drainage hose is clogged. The wash pump does not work properly.	Clean the tank filter. Clean the wash pump filter. Call service centre. Call service centre.
Low pressure from rinse arms.	Loss of performance	The rinse arms are clogged. The water pressure after pressure reducer is less than 2 bar [200 kPa].	Clean the rinse arms. Call service centre.
The wash pump does not work.	Blocking	The wash pump is clogged.	Call service centre.
The drain pump does not work.	Loss of performance	The drain pump is clogged.	Call service centre.
The dishwasher is switched off, but the appliance continues to fill water.	Loss of performance	Inlet valve is damaged.	Close the water supply tap or taps and call service centre.

If the fault persists after carrying out the above checks, contact the Customer Care Service, remembering to specify:

- A. the type of fault;
- B. the appliance PNC (product number code);
- C. the Ser. No. (appliance serial number).



IMPORTANT

The appliance PNC and serial number are essential for identifying the type of appliance and date of manufacture.

P ALARMS

P.1 Anomaly details



CAUTION

Only After-Sales Service or authorised personnel can do repair operations in the appliance.

1. Touch on "AppOne" icon to open the application.



2. Touch the  to open the main menu.

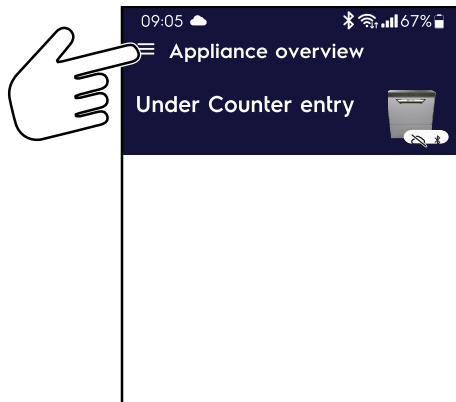

3. From main menu, touch the "Alerts" tab.

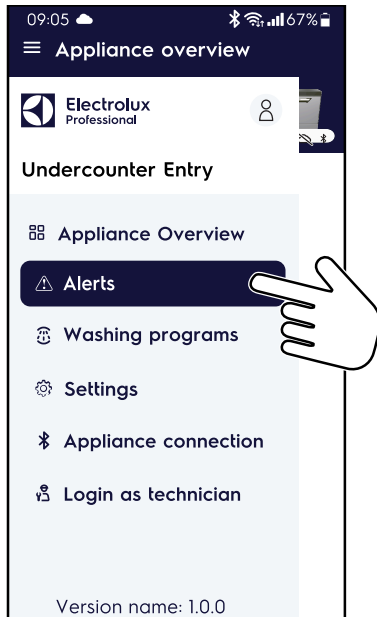

4. The smartphone display shows the active and solved alarm/warning list.



1	Type of anomaly: <ul style="list-style-type: none"> Warning Alarm
2	Anomaly code
3	Anomaly title

P.1.1 Alarm details

Touch on the corresponding alarm or warning to have additional information about current anomaly.

The smartphone display shows the below alarm/warning pop up.

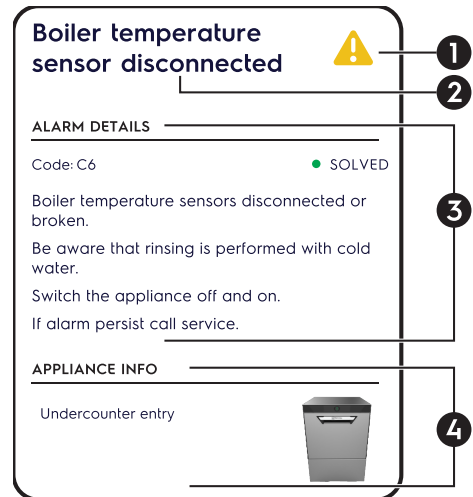

1	Type of anomaly: <ul style="list-style-type: none"> Warning Alarm
2	Anomaly title
3	Anomaly details <ul style="list-style-type: none"> Anomaly code Anomaly status: <ul style="list-style-type: none"> Active Solved Detailed description of the anomaly
4	Appliance information: <ul style="list-style-type: none"> Appliance type Appliance name (if assigned) Appliance Product Number Code and Serial Number

P.2 Alarm guide

Anomaly	Type of anomaly	Possible causes	Actions
A1 TANK FILLING TIMEOUT	Alarm Blocking	The tap is close. The water inlet filter is clogged. Too low pressure in hydraulic circuit. Overflow not inserted (only for appliances without drain pump). The O-ring on the overflow pipe is missing or worn.	Open the tap. Clean the water inlet filter. Check the minimum mains pressure. Insert properly the overflow (only for appliances without drain pump). Replace the O-ring.
B1 INEFFICIENT DRAINAGE	Warning Not blocking	Overflow not removed. The waste outlet pipe and/or the overflow aperture obstructed.	Remove the overflow. Remove any obstruction from the waste outlet pipe and/or the overflow aperture.
B2 TANK WATER LEVEL TOO HIGH	Warning Not blocking	The waste outlet pipe and/or the overflow aperture obstructed. The waste outlet pipe and/or the overflow aperture obstructed.	Remove any obstruction from the waste outlet pipe and/or the overflow aperture.
C2 BOILER TEM- PERATURE TOO HIGH	Warning Not blocking	Boiler temperature sensor out of order. Wrong parameters set.	Switch the appliance off and on. Call the service centre if alarm appears again.
C3 TANK TEMPER- ATURE TOO HIGH	Warning Not blocking	Tank temperature sensor out of order. Wrong parameters set.	Switch the appliance off and on. Call the service centre if alarm appears again.
C4-C5 TANK TEMPER- ATURE SENSOR OUT OF ORDER	Warning Not blocking	Tank temperature sensor broken or disconnected.	Switch the appliance off and on. Call the service centre if alarm appears again.
C6-C7 BOILER TEM- PERATURE SENSOR OUT OF ORDER	Warning Not blocking	Boiler temperature sensor broken or disconnected.	Switch the appliance off and on. Call the service centre if alarm appears again.
C8 RINSING PHASE FAILED FOR 2 CON- SECUTIVE TIMES	Alarm Blocking	Rinse arms clogged. Rinse pump out of order. Water in the slim tube from boiler air-trap to main board.	Remove wash and rinse arms and descale them with vinegar or scale remover. Call the service centre if alarm appears again.
C12 TANK LEVEL SENSOR OUT OF ORDER	Alarm Blocking	Tank level sensor broken or disconnected.	The tank level sensor has received a out of range value. Switch the appliance off and on. Call the service centre if alarm appears again.
D1 TANK HEATING TIMEOUT	Warning Not blocking	Tank heating element does not heat the water within the expected time.	Tank heating element broken or disconnected. Washing cycle is executed with cold water. Switch the appliance off and on. Call the service centre if alarm appears again.
D2 BOILER HEAT- ING TIMEOUT	Warning Not blocking	Boiler heating element does not heat the water within the expected time.	Boiler heating element broken or disconnected. Pay attention, rinse cycle is executed with cold water. Switch the appliance off and on. Call the service centre if alarm appears again.
E1¹ COMMUNICA- TION ERROR	Warning Not blocking	No communication between main board and user interface.	Switch the appliance off and on. Call the service centre if alarm appears again.

Anomaly	Type of anomaly	Possible causes	Actions
E2¹ TANK TEMPERATURE TOO LOW	Warning Not blocking	Wrong parameters set. Tank temperature sensor out of order. Tank heating element out of order. Tank pressure switch faulty.	Switch the appliance off and on. Call the service centre if alarm appears again.
E3¹ BOILER TEMPERATURE TOO LOW	Warning Not blocking	Wrong parameters set. Boiler temperature sensor out of order. Boiler heating elements out of order.	Switch the appliance off and on. Call the service centre if alarm appears again.

1. The appliance continues to operate, but appropriate checks by a technician are recommended.

CE