

Blast Chillers/Freezers

Lengthwise

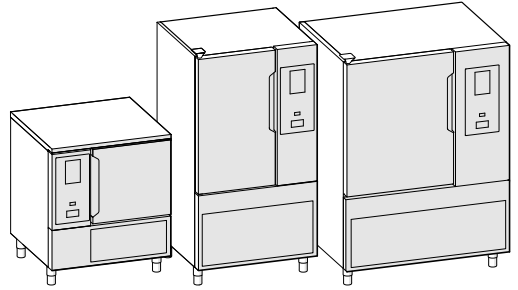

EN User manual *



*Original instructions

595R09C00- 2024.11

Foreword

 Read the following instructions, including the warranty terms before installing and using the appliance.

Visit our website www.electroluxprofessional.com and open the Support section to:

 Register your product

 Get hints & tips of your product, service and repair information

The installation, use and maintenance manual (hereinafter Manual) provides the user with information necessary for correct and safe use of the appliance.

The following must not be considered a long and exacting list of warnings, but rather a set of instructions suitable for improving appliance performance in every respect and, above all, preventing injury to persons and animals and damage to property due to improper operating procedures.

All persons involved in appliance transport, installation, commissioning, use and maintenance, repair and disassembly must consult and carefully read this manual before carrying out the various operations, in order to avoid wrong and improper actions that could compromise the appliance's integrity or endanger people. Make sure to periodically inform the user regarding the safety regulations. It is also important to instruct and update personnel authorised to operate on the appliance, regarding its use and maintenance.

The manual must be available to operators and carefully kept in the place where the appliance is used, so that it is always at hand for consultation in case of doubts or whenever required.

If, after reading this manual, there are still doubts regarding appliance use, do not hesitate to contact the Manufacturer or the authorised Service Centre to receive prompt and precise assistance for better operation and maximum efficiency of the appliance. During all stages of appliance use, always respect the current regulations on safety, work hygiene and environmental protection. It is the user's responsibility to make sure the appliance is started and operated only in optimum conditions of safety for people, animals and property.



IMPORTANT

- The manufacturer declines any liability for operations carried out on the appliance without respecting the instructions given in this manual.
- The manufacturer reserves the right to modify the appliances presented in this publication without notice.
- No part of this manual may be reproduced.
- This manual is available in digital format by:
 - contacting the dealer or reference customer care;
 - downloading the latest and up to date manual on the web site www.electroluxprofessional.com;
- The manual must always be kept in an easily accessed place near the appliance. Appliance operators and maintenance personnel must be able to easily find and consult it at any time.

Contents

A	WARNING AND SAFETY INFORMATION	5
A.1	General information	5
A.2	Personal protection equipment	5
A.3	General safety	6
A.4	Protection devices installed on the appliance	6
A.5	Safety signs to be placed on the appliance or near its area	7
A.6	Reasonably foreseeable improper use	7
A.7	Residual risks	7
A.8	UV-C emitter	8
A.9	Product loading and unloading	8
A.10	Maximum load	8
A.11	Appliance cleaning	8
A.12	Cleaning the cabinet and accessories	8
A.13	Preventive Maintenance	8
A.14	Parts and accessories	8
A.15	Precautions for use and maintenance	8
A.16	Appliance maintenance	9
A.17	Maintenance intervals	9
B	APPLIANCE AND MANUFACTURER'S IDENTIFICATION DATA	9
C	WARRANTY TERMS AND EXCLUSIONS	10
D	GENERAL INFORMATION	10
D.1	Introduction	10
D.2	Intended use and restrictions	10
D.3	Testing and inspection	10
D.4	Copyright	10
D.5	Keeping the manual	10
D.6	Recipients of the manual	11
D.7	Definitions	11
D.8	Responsibility	11
E	NORMAL MACHINE USE	11
E.1	Characteristics of personnel enabled to operate on the appliance	11
E.2	Basic requirements for appliance use	11
F	OPERATING	12
F.1	Appliance features	12
F.2	Control panel	12
F.3	Starting page	12
F.4	Touch screen main icons	12
F.5	Appliance main cycles	13
F.6	Appliance connectivity	13
F.7	Drawers area	13
F.7.1	Delayed Start	15
F.8	Manual mode	16
F.8.1	Cycle setting	16
F.8.2	Multiphase drawer	21
F.9	Automatic mode	23
F.9.1	Cycles+/Special cycles	24
F.10	Programs mode	28
F.11	Homepage mode (SkyHub/SoloMio)	31
F.12	Hygiene mode	32
F.13	Settings mode	33
F.14	Help mode	37
F.15	Agenda mode (My Planner/Calendar)	37
F.16	Usb mode	39
F.17	Graphs mode	41
F.18	SKYDUO/MATCH MODE (depending on your model - optional)	42
G	MACHINE CLEANING AND MAINTENANCE	44
G.1	Ordinary maintenance	44
G.1.1	Care information	44
G.1.2	Cleaning introduction	44
G.1.3	Appliance Cleaning	44
G.1.4	Cleaning the probe	44
G.1.5	Cleaning tray supports and internal structure	44
G.1.6	Cleaning drain plug	44
G.1.7	Cleaning other surfaces	45
G.1.8	Periods of non-use	45
H	TROUBLESHOOTING	45
H.1	Introduction	45
H.2	Anomaly table	45
H.3	Appliance connectivity issues (depending on your SW version)	49
I	FURTHER INFORMATION	50
I.1	Ergonomic features	50
I.1.1	Certification	50

A WARNING AND SAFETY INFORMATION

A.1 General information

To ensure safe use of the appliance and a proper understanding of the manual it is necessary to be familiar with the terms and typographical conventions used in the documentation. The following symbols are used in the manual to indicate and identify the various types of hazards:



WARNING

Danger for the health and safety of operators.



WARNING

Danger of electrocution - dangerous voltage.



CAUTION

Risk of damage to the appliance or the product.



WARNING

Risk of fire / Flammable materials



IMPORTANT

Important instructions or information on the product



Equipotentiality



Read the instructions before using the appliance











Clarifications and explanations

- Only specialised personnel are authorised to operate on the appliance.
- This appliance is to be intended for commercial and collective use, for example in kitchens of restaurants, canteens, hospitals and in commercial enterprises such as bakeries, butcheries, etc., not for continuous mass production of food. Any other use is deemed improper.
- This appliance is not intended for use by persons (including children) with reduced physical, sensory or mental capabilities, or lack of experience and knowledge, unless they have been given supervision or instruction concerning use of appliance by a person responsible for their safety.
- (ONLY FOR EUROPE) This appliance can be used by children aged from 8 years and above and persons with reduced physical, sensory or mental capabilities or lack of experience and knowledge if they have been given supervision or instruction concerning use of the appliance in a safe way and understand the hazards involved.
- Children should be supervised to ensure that they do not play with the appliance.
- Keep all packaging and detergents away from children.
- Cleaning and user maintenance shall not be made by children without supervision.
- For your safety do not store or use gasoline or other flammable materials, vapours and liquids in the vicinity of this or any other appliance.
- Do not store explosive substances, such as pressurized containers with flammable propellant, in this appliance.
- Refer to the data given on the appliance's data plate for relations with the Manufacturer (e.g. when ordering spare parts, etc.).
- When scrapping the appliance, the marking must be destroyed.
- Save these instructions carefully for further consultation by the various operators.

A.2 Personal protection equipment

Summary table of the Personal Protection Equipment (PPE) to be used during the various stages of the appliance's service life.

Stage	Protective garments	Safety footwear	Gloves	Glasses	Safety helmet
					
Transport	—	●	○	—	○
Handling	—	●	○	—	—
Unpacking	—	●	○	—	—
Installation	—	●	● ¹	—	—

Stage	Protective garments 	Safety footwear 	Gloves 	Glasses 	Safety helmet 
Normal use	●	●	● ²	—	—
Adjustments	○	●	—	—	—
Routine cleaning	○	●	● ¹⁻³	○	—
Extraordinary cleaning	○	●	● ¹⁻³	○	—
Maintenance	○	●	○	—	—
Dismantling	○	●	○	○	—
Scrapping	○	●	○	○	—
Key:					
●	PPE REQUIRED				
○	PPE AVAILABLE OR TO BE USED IF NECESSARY				
—	PPE NOT REQUIRED				

1. During these operations, gloves must be cut-resistant. Failure to use the personal protection equipment by operators, specialized personnel or users can involve exposure to harm to health (depending on the model).

2. During these operations, gloves must protect hands from the cold tray when being removed from the appliance. Failure to use the personal protection equipment by operators, specialised personnel or users can involve exposure to chemical risk and cause possible harm to health (depending on the model).

3. During these operations, gloves must be suitable for contact with chemical substances used (refer to the safety data sheet of the substances used for information regarding the required PPE). Failure to use the personal protection equipment by operators, specialized personnel or users can involve exposure to chemical risk and cause possible harm to health (depending on the model).

A.3 General safety

- The appliances are provided with electric and/or mechanical safety devices for protecting workers and the appliance itself.
- Never operate the appliance, removing, modifying or tampering with the guards, protection or safety devices.
- Do not make any modifications to the parts supplied with the appliance.
- Several illustrations in the manual show the appliance, or parts of it, without guards or with guards removed. This is purely for explanatory purposes. Do not use the appliance without the guards or with the protection devices deactivated.

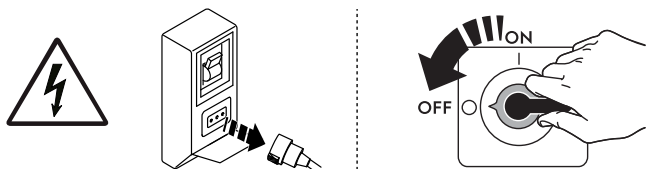

Disconnect the appliance from the power supply before carrying out any installation, assembly, cleaning or maintenance procedure.

- Do not remove, tamper with or make illegible the marking and safety, danger and instruction signs and labels on the appliance.
- The A-weighted emission sound pressure level does not exceed 70 dB(A).¹
- Carefully avoid exposure of the equipment to ozone - do not use ozonizers in the rooms where the equipment is installed.
- The following operations have to be carried out by specialised authorised personnel or Customer Care Service provided with all the appropriate personal protection equipment (A.2 *Personal protection equipment*), tools, utensils and ancillary means, who can ask the manufacturer to supply a servicing manual:
 - Installation and assembly
 - Installation of the refrigerant fluid condensing unit
 - Positioning
 - Electrical connection
 - Appliance cleaning, repair and extraordinary maintenance
 - Appliance disposal
 - Work on electrical equipment
 - Dismantling operations of appliances which use R290 or R-744 (with a refrigeration system under high pressure)
 - Dismantling operations of appliances which use flammable insulation blowing gases;

A.4 Protection devices installed on the appliance

Guards





The appliance has:

- fixed guards (e.g. casings, covers, side panels, etc.), fixed to the appliance and/or frame with screws or quick-release connectors that can only be removed or opened with tools; therefore the user must not remove or tamper with such devices. The Manufacturer declines any liability for damage due to tampering or their non-use;
- interlocked movable guards (door) for access inside the appliance;

1. The noise emission values have been obtained according to EN ISO 11204. The value could increase depending on the workplace where measured.

- appliance electrical equipment access panels or doors, made from hinged panels openable with tools. The panel or the door must not be opened when the appliance is connected to the power supply.

A.5 Safety signs to be placed on the appliance or near its area

Prohibition	Meaning
	do not remove the safety devices
	do not use water to extinguish fires (placed on electrical parts)
Danger	Meaning
	caution hot surface
	danger of electrocution (shown on electrical parts with indication of voltage)

A.6 Reasonably foreseeable improper use

Improper use is any use different from that specified in this manual. During appliance operation, other types of work or activities deemed improper and that in general can involve risks for the safety of operators and damage to the appliance are not allowed. Reasonably foreseeable improper use includes:

- lack of appliance maintenance, cleaning and periodical checks;
- structural changes or modifications to the operating logic;
- tampering with the guards or safety devices;
- failure to use personal protection equipment by operators, specialised personnel and maintenance personnel;
- failure to use suitable accessories (e.g. use of unsuitable equipment or ladders);
- keeping combustible or flammable materials, or in any case materials not compatible with or pertinent to the work, near the appliance;
- wrong appliance installation;
- placing in the appliance any objects or things not compatible with its use, or that can damage the appliance, cause injury or pollute the environment;
- climbing on the appliance;
- non-compliance with the requirements for correct appliance use;
- other actions that give rise to risks not eliminable by the Manufacturer.

A.7 Residual risks

The appliance has several risks that were not completely eliminated from a design standpoint or with the installation of adequate protection devices. Nevertheless, through this manual the Manufacturer has taken steps to inform operators of such risks, carefully indicating the personal protection equipment to be used by them. In order to reduce the risks, provide for sufficient spaces while installing the unit.

To preserve these conditions, the areas around the appliance must always be:

- kept free of obstacles (e.g. ladders, tools, containers, boxes, etc.);
- clean and dry;
- well lit.

For the Customer's complete information, the residual risks remaining on the appliance are indicated below: such actions are deemed improper and therefore strictly forbidden.

Residual risk	Description of hazardous situation
Slipping or falling	The operator can slip due to water, any liquid or dirt on the floor
Burns/abrasions (e.g. heating elements, cold pan, cooling circuit plates and pipes)	The operator deliberately or unintentionally touches some components inside the appliance without using protective gloves.
Electrocution	Contact with live parts during maintenance operations carried out with the electrical panel powered
Falling from above	The operator intervenes on the appliance using unsuitable systems to access the upper part (e.g. rung ladders, or climbs on it)
Crushing or injury	The specialised personnel may not correctly fix the control panel when accessing the technical compartment. The panel could close suddenly.

Residual risk	Description of hazardous situation
Tipping of loads	When handling the appliance or the packing containing it, using unsuitable lifting systems or accessories or with the unbalanced load
Chemical (refrigerant gas)	Inhalation of refrigerant gas. Therefore always refer to the appliance labels

A.8 UV-C emitter

Residual risk	Description of hazardous situation
Harm to eyesight and skin	Exposure to UV-C rays for appliances with germicidal lamp, in case of door interlock fault.



IMPORTANT

If the appliance contains a UV-C emitter, do NOT stare at the light source.

A.9 Product loading and unloading

- Cover or wrap food before placing it in the refrigerator and avoid putting very hot foods or steaming liquids inside.
- In appliances with ramp, handle the trolley tray rack carefully, to avoid its overturning and the spilling of liquids.
- Use kitchen gloves when loading and removing food.

A.10 Maximum load

- Regarding the maximum load for each appliance and each shelf, respect that given in the table below:

Models	Appliance maximum load (kg)	Shelf maximum load (kg)
SKCH30BHC (30kg)	30	40 (88.18 lb)
SKCH50BHC (50kg)	50	40 (88.18 lb)
SKCH70BHC (70kg)	100	40 (88.18 lb)

A.11 Appliance cleaning

- Do not touch the appliance with wet hands or feet or when barefoot.
- Use a ladder with suitable protection for work on appliances with high accessibility.
- Put the appliance in safe conditions before starting any cleaning operation.
- Respect the requirements for the various routine and extraordinary maintenance operations. Non-compliance with the instructions can create risks for personnel.
- Do not spray water or use water jets, steam cleaner or high pressure cleaner.

A.12 Cleaning the cabinet and accessories

- Pay attention to the selection and use of cleaning products in order to maintain proper appliance performance and safeness.
- Before using the appliance, clean all the internal parts and accessories with lukewarm water and neutral soap, or products that are over 90% biodegradable (in order to reduce the emission of pollutants into the environment), then rinse and dry thoroughly, where possible clean with dishwashing appliance.
- Do not clean the appliance with detergents containing chlorine, solvent-based cleaning products (e.g. trichloro-ethylene), abrasive powders or agents, scouring pads or sponges that could damage the surfaces. Do not use organic solvent substances or essential oils. These substances could damage the parts of the appliance made from synthetic material.
- Do not use products (even if diluted) containing chlorine (sodium hypochlorite, hydrochloric or muriatic acid, etc.) to clean the floor under the appliance.
- Pay particular attention when handling the probe; it is a sharp object, therefore handle it very carefully during cleaning.

A.13 Preventive Maintenance

In order to ensure the safety and performance of your equipment, it is recommended that service is undertaken by Electrolux Professional SpA authorised engineers every 12 months, in accordance with Electrolux Professional SpA Service Manuals. Please contact your local Electrolux Professional SpA Service Centre for further details.

A.14 Parts and accessories

Use only original accessories and/or spare parts. Failure to use original accessories and/or spare parts will invalidate the original manufacturer warranty and may render the appliance not compliant with the safety standard.

A.15 Precautions for use and maintenance

- Risks mainly of a mechanical, thermal and electrical nature exist in the appliance. Where possible the risks have been neutralised:
 - directly, by means of adequate design solutions.
 - indirectly by using guards, protection and safety devices.
- Any anomalous situations are signalled on the control panel display.
- During maintenance several risks remain, as these could not be eliminated, and must be neutralised by adopting specific measures and precautions.
- Do not carry out any checking, cleaning, repair or maintenance operations on moving parts. Workers must be informed of this prohibition by means of clearly visible signs.

- Make sure to periodically check correct operation of all the safety devices and the insulation of electrical cables, which must be replaced if damaged.

In case of a significant anomaly (e.g. short circuits, wires coming out of the terminal block, motor breakdowns, worn electrical cable sheathing, etc.) the operator for normal appliance use must:

- immediately deactivate the appliance.

A.16 Appliance maintenance

- The inspection and maintenance intervals depend on the actual appliance operating conditions and ambient conditions (presence of dust, damp, etc.), therefore precise time intervals cannot be given. In any case, careful and periodical appliance maintenance is advisable in order to minimise service interruptions.
- It is advisable to stipulate a preventive and scheduled maintenance contract with the Customer Care Service.
- Put the appliance in safe conditions before starting any maintenance operation.
- To guarantee appliance efficiency and correct operation, periodical maintenance must be carried out according to the instructions given in the manual.

A.17 Maintenance intervals

It is advisable to carry out the checks with the frequency given in the following table:

Maintenance, inspections, checks and cleaning	Frequency	Responsibility
Ordinary cleaning <ul style="list-style-type: none"> • general cleaning of appliance and surrounding area 	• Daily	• Operator
Mechanical protection devices <ul style="list-style-type: none"> • check their condition and for any deformation, loosening or removed parts 	• Yearly	• Service
Control <ul style="list-style-type: none"> • check the mechanical parts, for cracks or deformations, tightening of screws: check the readability and condition of words, stickers and symbols and restore if necessary 	• Yearly	• Service
Appliance structure <ul style="list-style-type: none"> • tightening of main bolts (screws, fixing systems, etc.) of appliance 	• Yearly	• Service
Safety signs <ul style="list-style-type: none"> • check the readability and condition of safety signs 	• Yearly	• Service
Electrical control panel <ul style="list-style-type: none"> • check the electrical components installed inside the electrical control panel. Check the wiring between the electrical panel and appliance parts 	• Yearly	• Service
Electrical connection cable <ul style="list-style-type: none"> • check the connection cable (replace if necessary) 	• Yearly	• Service
General appliance overhaul <ul style="list-style-type: none"> • check all components, electrical equipment, corrosion, pipes... 	Every 10 years ¹	• Service

1. The appliance is designed and built for a duration of about 10 years. After this period of time (from commissioning) the appliance must undergo a general inspection and overhaul.

B APPLIANCE AND MANUFACTURER'S IDENTIFICATION DATA

The data plate gives the product identification and technical data.



An example of the marking or data plate on the appliance is given below:

F.Mod. XXXXXXXXX	Comm.Model XXXXXXXXX	Type ref. XXXXXX	2023
PNC 9V7X XXXXXXXXX	Ser.No. XXXXXXXXX	Cyclopentane	
W Tot. XXX kW	Volt XXXX XXX XXHz	Total Current XX A	
Evaporation Heater El.	x kW	Class X	GWP XXXX CO2-eq XXX t
Lighting	x W	Refrigerant	XXXXX XX Kg
Defrost Power	XXX kW	Cap. x	
NF nominal Charge			
Rated Pressure	Mpa		
IPxx		CE	
Electrolux Professional SPA - Viale Treviso, 15 - 33170 Pordenone (Italy)			

The meaning of the various information given on it is listed below:

F.Mod.	factory description of product
Comm.Mod.	commercial description
PNC	production number code
Ser.No.	serial number
Type ref.	certification group of the appliance
Cyclopentane	expanding gas used in insulation
V	power supply voltage
Hz	power supply frequency
kW	power input

A	absorbed current
Evaporation heater El.	evaporation heating element power
Class	climatic class
GWP	global warming potential
CO2 eq	quantity of greenhouse gases
Lighting	internal light
Cap.	nominal capacity

Refrigerant	type of refrigerant gas
Defrost power	current absorbed
	CE marking
	WEEE symbol
IPX4	dust and water protection rating

C WARRANTY TERMS AND EXCLUSIONS

If the purchase of this product includes warranty coverage, warranty is provided in line with local regulations and subject to the product being installed and used for the purposes as designed, and as described within the appropriate equipment documentation.

Warranty will be applicable where the customer has used only genuine spare parts and has performed maintenance in accordance with Electrolux Professional user and maintenance documentation made available in paper or electronic format.

Electrolux Professional strongly recommends using Electrolux Professional approved cleaning, rinse and descaling agents to obtain optimal results and maintain product efficiency over time.

The Electrolux Professional warranty does not cover:

- service trips cost to deliver and pick up the product;
- installation;
- training on how to use/operate;
- replacement (and/or supply) of wear and tear parts unless resulting from defects in materials or workmanship reported within one (1) week from the failure;
- correction of external wiring;
- correction of unauthorized repairs as well as any damages, failures and inefficiencies caused by and/or resulting from:
 - insufficient and/or abnormal capacity of the electrical systems (current/voltage/frequency, including spikes and/or outages);
 - inadequate or interrupted water supply, steam, air, gas (including impurities and/or other that does not comply with the technical requirements for each appliance);
 - plumbing parts, components or consumable cleaning products that are not approved by the manufacturer;

- customer's negligence, misuse, abuse and/or non-compliance with the use and care instructions detailed within the appropriate equipment documentation;
- improper or poor: installation, repair, maintenance (including tampering, modifications and repairs carried out by third parties not authorized) and modification of safety systems;
- Use of non-original components (e. g.: consumables, wear and tear, or spare parts);
- environment conditions provoking thermal (e. g. overheating/freezing) or chemical (e. g. corrosion/oxidation) stress;
- foreign objects placed in- or connected to- the product;
- accidents or force majeure;
- transportation and handling, including scratches, dents, chips, and/or other damage to the finish of the product, unless such damage results from defects in materials or workmanship and is reported within one (1) week of delivery unless otherwise agreed;
- product with original serial numbers that have been removed, altered or cannot be readily determined;
- replacement of light bulbs, filters or any consumable parts;
- any accessories and software not approved or specified by Electrolux Professional.

Electrolux Professional warranty will be void and manufacturer shall have no liability related thereto in case of any modification of the product or related hardware/software/programming.

Warranty does not include scheduled maintenance activities (including the parts required for it) or the supply of cleaning agents unless specifically covered within any local agreement, subject to local terms and conditions.

Check on Electrolux Professional website the list of authorized customer care.

D GENERAL INFORMATION

D.1 Introduction

This manual contains information relevant to various appliances. The product images in this guide are only an example.

The drawings and diagrams given in the manual are not in scale. They supplement the written information with an outline, but are not intended to be a detailed representation of the appliance supplied.

The numerical values given on the appliance installation diagrams refer to measurements in millimeters and/or inches.

D.2 Intended use and restrictions

This appliance has been designed for the blast chilling and/or blast freezing, preservation of foods (it rapidly lowers the temperature of cooked foods in order to preserve their initial qualities and guarantee their good condition for several days) and for food warming.

Any other use is deemed improper.



NOTE!

The manufacturer declines any liability for improper use of the product.

D.3 Testing and inspection

Our appliances have been designed and optimized, with laboratory testing, in order to obtain high performance and efficiency.

The appliance is shipped ready for use.

Passing of the tests (visual inspection - electrical test - functional test) is guaranteed and certified by the specific enclosures.

D.4 Copyright

This manual is intended solely for consultation by the operator and can only be given to third parties with the permission of Electrolux Professional SpA.

D.5 Keeping the manual

The manual must be carefully kept for the entire life of the appliance, until scrapping. The manual must stay with the appliance in case of transfer, sale, hire, granting of use or leasing.

D.6 Recipients of the manual

This manual is intended for:

- the employer of appliance users and the workplace manager;
- operators for normal appliance use;
- specialised personnel - Customer Care service (see service manual).

D.7 Definitions

Listed below are the definitions of the main terms used in the manual. It is advisable to read them carefully before use.

Operator	appliance installation, adjustment, use, maintenance, cleaning, repair and transport personnel.
Manufacturer	Electrolux Professional SpA or any other service centre authorised by Electrolux Professional SpA.
Operator for normal appliance use	an operator who has been informed and trained regarding the tasks and hazards involved in normal appliance use.
Customer Care service or specialised personnel	an operator instructed/trained by the Manufacturer and who, based on his professional and specific training, experience and knowledge of the accident-prevention regulations, is able to appraise the operations to be carried out on the appliance and recognise and prevent any risks. His professionalism covers the mechanical, electrotechnical and electronics fields etc.
Danger	source of possible injury or harm to health.
Hazardous situation	any situation where an operator is exposed to one or more hazards.
Risk	a combination of probabilities and risks of injury or harm to health in a hazardous situation.
Protection devices	safety measures consisting of the use of specific technical means (guards and safety devices) for protecting operators against risks.
Guard	an element of a appliance used in a specific way to provide protection by means of a physical barrier.

Safety device	a device (other than a guard) that eliminates or reduces the risk; it can be used alone or in combination with a guard.
Customer	the person who purchased the appliance and/or who manages and uses it (e. g. company, entrepreneur, firm).
Electrocution	an accidental discharge of electric current on a human body.

D.8 Responsibility

The Manufacturer declines any liability for damage and malfunctioning caused by:

- non-compliance with the instructions contained in this manual;
- repairs not carried out in a workmanlike fashion, and replacements with parts different from those specified in the spare parts catalogue (the fitting and use of non-original spare parts and accessories can negatively affect appliance operation and invalidates the original manufacturer warranty);
- operations carried out by non-specialised personnel;
- unauthorized modifications or operations;
- missing, lack or inadequate maintenance;
- improper appliance use;
- unforeseeable extraordinary events;
- use of the appliance by uninformed and / or untrained personnel;
- non-application of the current provisions in the country of use, concerning safety, hygiene and health in the workplace.

The Manufacturer declines any liability for damage caused by arbitrary modifications and conversions carried out by the user or the Customer.

The employer, workplace manager or service technician are responsible for identifying and choosing adequate and suitable personal protection equipment to be worn by operators, in compliance with regulations in force in the country of use.

The Manufacturer declines any liability for inaccuracies contained in the manual, if due to printing or translation errors.

Any supplements to the installation, use and maintenance manual the Customer receives from the Manufacturer will form an integral part of the manual and therefore must be kept together with it.

E NORMAL MACHINE USE

E.1 Characteristics of personnel enabled to operate on the appliance

The Customer must make sure the personnel for normal appliance use are adequately trained and skilled in their duties.

The operator must:

- read and understand the manual;
- receive adequate training and instruction for their duties in order to operate safely;
- receive specific training for correct appliance use.



IMPORTANT

The Customer must make sure his personnel have understood the instructions received and in particular those regarding work hygiene and safety in use of the appliance.

E.2 Basic requirements for appliance use

- Knowledge of the technology and specific experience in operating the appliance.
- Adequate general basic education and technical knowledge for reading and understanding the contents of the manual, including correct interpretation of the drawings, signs and pictograms.
- Sufficient technical knowledge for safely performing his duties as specified in the manual.
- Knowledge of the regulations on work hygiene and safety.

F OPERATING

F.1 Appliance features

The appliance allows to chill, freeze, preserve food.

It rapidly lowers the temperature of cooked food maintaining the product's quality intact and guaranteeing its good condition for several days.

F.2 Control panel

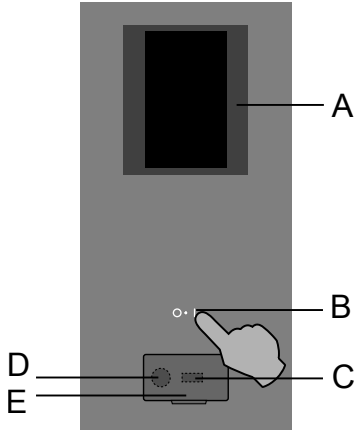

- A. Display-Touch screen
- B. ON/OFF button
- C. USB key in/out
- D. Connection for accessories / Recovery Data
- E. Openable flap

F.3 Starting page

When the appliance is switched on the display illuminates, loads the software and after a while shows, by default, the starting page in MANUAL mode.

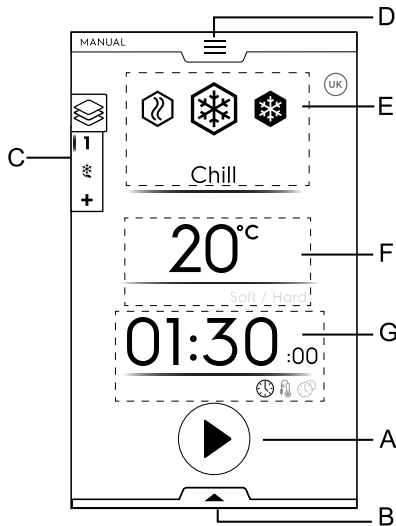

- A. Start button
- B. Utilities drawer (lower drawer)
- C. Multiphase drawer
- D. Main menu' drawer (upper drawer)
- E. Main cycles
- F. Cavity temperature
- G. Time/Food Probe/Multitimer area

F.4 Touch screen main icons

Temperature area

20°C Current temperature

Time / food probe / multitimer area

01:30 Chilling time

Time signalling icon

Probe signalling icon

Estimated time remaining icon

Multitimer signalling icon

Multiphase drawer area

Multiphase drawer icon

Food can be chilled, freezed or cooked in different phases. The appliance enables programmes consisting of several sequential phases.

Information icons

Fan speed level
(only available on 6GN 1/1 – 10GN 1/1 – 10GN 2/1 models)

Touching the icon, it is possible to set the speed of the cavity fan.

Door open Warning signalling icon

The icon appears when the door is open or not properly closed

Compressor on signalling icon

The icon appears when the compressor starts to operate with pulses.

It remains on the display until the compressor finishes to operate.

Tuoch the icon to open the pop-up window information.

Defrost cycle activated signalling icon

The icon appears when the defrosting is in progress.

The icon remains on the display until the end of defrost.

Touch the icon to open the pop-up window information.

Hold down the icon for a few seconds to skip the defrosting. (only if the icon in the screen saver is white)

Touch screen commands

Confirm and save the selection

Discard the selection or close a pop-up

Come back to the previous menu

Start icon



Stop icon
(hold down the button for a few seconds)



Move between the pages (horizontal scrolling) or increase/decrease a value



Move between the pages (vertical scrolling)

Signalling icons



Alarms signalling icon

A pop-up window automatically appears on the display to show the alarm in progress.

The icon remains visible on the display until the problem is resolved.



Warnings

A pop-up window automatically appears on the display to show the warning in progress.



Information

Information message communicates if something is wrong, if a procedure is completed or should be repeated and so on.

F.5 Appliance main cycles



Chill cycle
(temperature range: +10°C; -41°C)¹

The positive blast chilling cycle is suitable for foods to be consumed within a few days. It is possible to choose among two temperature presets from temperature pop-up window.

- **Soft:** recommended for foods such as vegetables or pieces of food that are not very thick.
The default values for soft chilling are 0°C and 1:30 minutes. If the regulation changes the values change.
- **Hard:** recommended for larger pieces of food.
The default values for hard chilling are -20°C and 1:30 minutes. If the regulation changes the values change.

1. Depending on the model



Freeze cycle¹
(temperature range: +10°C; -41°C)

Freezing allows foods to be preserved for longer periods (weeks or months).

Fast freezing consists of reaching a negative temperature (-18°C / -0.4°F) in the core of the product in the shortest possible time.

The default values for freeze are -41°C and 4:00 h:m. If the regulation changes the values change.

This ensures that the tissues are not damaged when the product thaws and the food preserves its appearance and nutritional components. With this cycle, the temperature of the food is between -20°C(-4°F) and -18°C (-0.4°F) after freezing.

1. Available depending on the model.



Lite hot
(temperature range: +40°C; -18°C)

Lite Hot allows to heat food for limited cooking functions up to +40°C (proving, thawing).

Selecting Lite hot cycle or during a Multiphase cycle with mixed phases (Chill-Freeze-Lite hot), Norms is automatically disabled.

If the last phase is Lite hot there is not the automatic holding phase.

F.6 Appliance connectivity

If the appliance is connected remotely to Cloud, the display will show different icons that indicate the connection status.



Connection status icons



Appliance connected to cloud via Wifi. The Wifi signal is **good**.



Appliance connected to cloud via Wifi. The Wifi signal is **medium**.



Appliance connected to cloud via Wifi. The Wifi signal is **poor**.



Appliance connected to cloud via Ethernet.

For connection issues, refer to H.3 *Appliance connectivity issues (depending on your SW version)* paragraph.

F.7 Drawers area

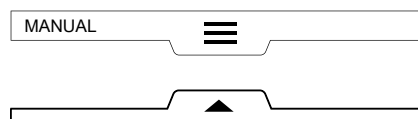

The drawers are an expansion located inside several environments of the menu and contains options and functions.

The composition of the drawers depends on the setting parameters (see chapter F.13 *Settings mode*).

• UPPER DRAWER

It allows to navigate into the main menu.

- Upper drawer opening:

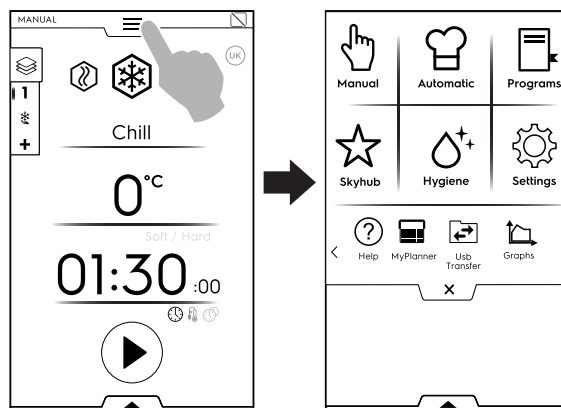

– Moving between pages:

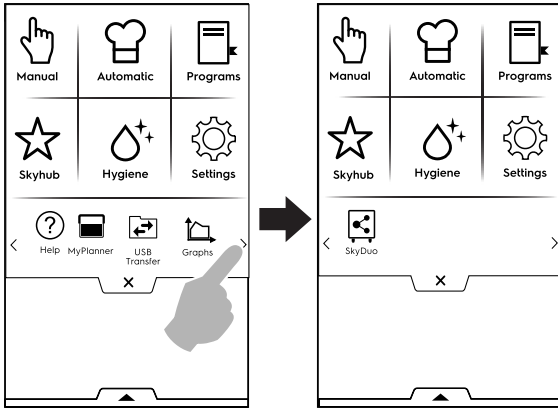

Touch the required icon in the main menu to access inside the different modes.

– Upper Drawer closing:

Touch the **X** to close it.

Upper drawer main menu

Manual mode

“Manual” mode allows to customize the cycles choosing among Lite hot – Chill – XFreeze cycles, setting time and temperature.

(see chapter F.8 *Manual mode*)

Automatic mode

“Automatic” mode allows to be guided by the Blast Chiller on the best cycle according to the required food automatically, just setting a few simple functions.

(see chapter F.9 *Automatic mode*)

Programs mode

“Programs” mode allows to recall programs or recipes already stored and create and stored new ones.

(see chapter F.10 *Programs mode*)

Homepage mode (SkyHub/SoloMio)

“Homepage” mode allows you to customize the display menu according to your needs.

(see chapter F.11 *Homepage mode (SkyHub/SoloMio)*)

Hygiene mode

“Hygiene” mode allows to clean the appliance cavity automatically choosing the most suitable program.

(see chapter F.12 *Hygiene mode*)

Settings mode

“Settings” mode allows to customize the appliance functions for a better use.

It allows to enable or disable the various environments and modify their options.

(see chapter F.13 *Settings mode*)

< Scrolling area >

Help

This function provides QR codes in order to display the user manual on your mobile, tablet or laptop.

(see chapter F.14 *Help mode*)

Agenda (My Planner/Calendar)

This function allows to plan appliance activities, chilling — freezing — hot cycles, hygiene programs or to set reminders, according to your schedule.

(see chapter F.15 *Agenda mode (My Planner/Calendar)*)

USB Transfer

“USB” mode allows to upload/download, from or into the appliance, programs or other datas by means of the usb pendrive.

(see chapter F.16 *Usb mode*)

Graphs

“Graphs” mode allows to show the graphical behaviour of chilling cycles, both Manual, Programs and Automatic ones.

(see chapter F.17 *Graphs mode*)

SkyDuo (Match)



NOTE!

Available as option only on specific models combined with the appropriate accessory.

This function can be activated on demand and it works combined with connectivity devices, installed by specialised personnel.

It allows you to connect the oven to a blast chiller.

(see chapter F.18 *SKYDUO/MATCH MODE (depending on your model - optional)*)

• LOWER DRAWER

It allows to access to some options and to special functions.

– Lower drawer opening:

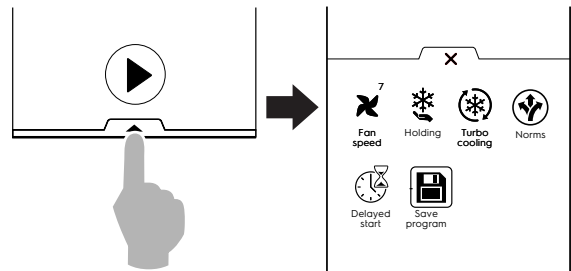

– Lower Drawer closing:

Touch the **X** to close it.

Lower drawer functions – Utilities

Fan speed
(only available on 6GN 1/1 – 10GN 1/1 – 10GN 2/1 models)

Touching the icon, it is possible to set the speed of the cavity fan.

Holding cycle

The Holding cycle keeps food at a chosen temperature so that it does not alter over time.

It is possible to choose between a positive Holding cycle (3°C) and a negative Holding cycle (-22°C).

It starts automatically at the end of the chilling or freezing cycles.

Holding cycle is continuous, it is necessary to operate on the programme in order to interrupt it.

Turbo cooling cycle

The appliance works continuously at the desired temperature; ideal for continuous production.

Delayed start

With this option it will be possible to delay the start of a cycle at a more convenient time.

(see paragraph F.7.1 *Delayed Start*)

Save program

This feature allows to save and store customized cycles in Program mode.

(see paragraph *How to create and save a program* in chapter F.10 *Programs mode*)

Norms (Reference standards)

The appliance can be set in accordance with 4 different standards:

- NF (French)
- UK (British)
- NFS
- CUSTOM (defined by user)



NOTE!

The correct end of cycle temperature and time limits set by the NF, UK, NFS standards are fixed and cannot be changed by the user, whereas the CUSTOM standard is configurable.

For example, if the NF setting is used, a positive blast chilling cycle with core probe ends correctly if the temperature of 10°C (50°F) is reached within 110 minutes. Chilling in this way is concluded and the appliance automatically switches to positive maintaining.

SOFT / HARD CHILLING

Guidelines	Chilling start temperature	Chilling end temperature	Chilling duration
NF	+63°C (145.4°F)	+10°C (50°F)	110 minutes
UK	+70°C (158°F)	+3°C (37.4°F)	90 minutes
NFS	+135°F (+57°C)	+40°F (+4°C)	240 minutes
CUSTOM	CbSt°C	CCEt°C	CCtl minutes

FREEZING

Guidelines	Freezing start temperature	Freezing end temperature	Freezing duration
NF	+63°C (145.4°F)	-18°C (64.4°F)	270 minutes

UK	+70°C (158°F)	-18°C (-0.4°F)	240 minutes
NFS	+57°C (135°F)	-18°C (-0.4°F)	360 minutes
CUSTOM	CbSt°C	CFEt°C	CFtl minutes

If at the end of the cycle the “Chilling/Freezing time” is higher than “Chilling/Freezing duration”, an “Overtime Alarm” will be generated and stored among the HACCP alarms.

The display shows the results of the normative check at the end of the cycle with a tick or a cross near the guideline icon.

F.7.1 Delayed Start

Delayed start is visible on bottom drawer only if enabled from Settings mode (see chapter F.13 *Settings mode* (Settings ⇒ Manual ⇒ Utilities ⇒ Delayed start)).

1. Open the lower drawer and touch the Delayed start icon .

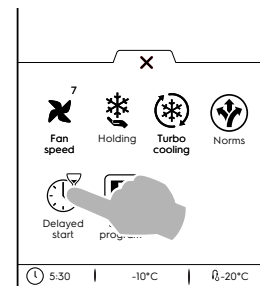

2. Set the Delayed start on the numeric keypad and start the cycle.

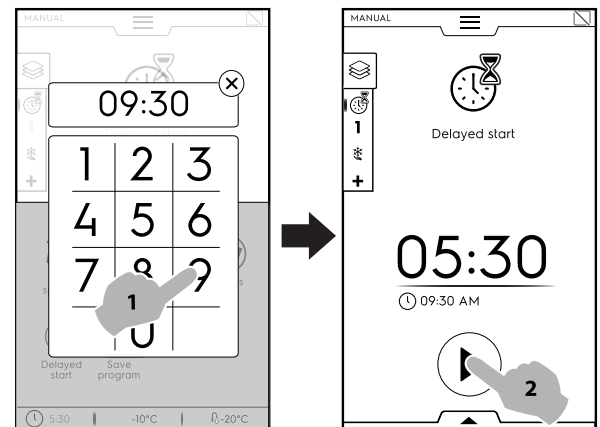

3. The display shows the countdown of the remaining time to the cycle start.

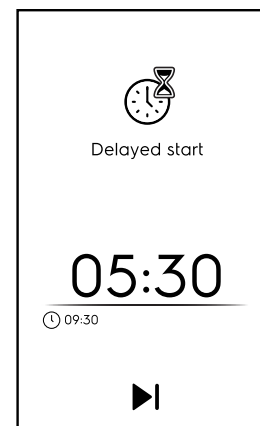

- If you want the appliance to perform the preparation phase for the delayed cycle, see chapter F.13 *Settings mode* (Manual ⇒ General, ⇒) and enable the feature “Delayed start precooling” (☑ / ☐).

In this case the appliance asks to perform the preparation phase (precooling/preheating) for the cycle at the set time.

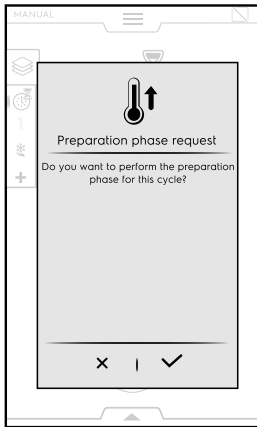

Touch the ✓ to execute the preparation phase or touch X to disable it.

The appliance starts the countdown. The display shows the delay start icon, the remaining time and the set starting time.

It is still possible to skip the delay and start immediately the cycle. In this case the appliance starts the preparation phase.

▶ Skip Delay start

F.8 Manual mode

F.8.1 Cycle setting

- Press the ON/OFF button to switch the appliance on.

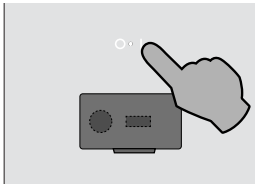

The display illuminates and shows, by default the main screen of the MANUAL mode.

- Select a cycle (for example Chill cycle).

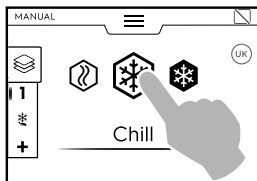

- If the default parameters are suitable for food, touch the button ▶ to start the cycle.

If it is necessary to stop the cycle, hold down the button



- Precooling (or preheating) starts.



NOTE!

This phase can be enabled or disabled in chapter F.13 *Settings mode* (Manual ⇒ General, ⇒ Precooling).

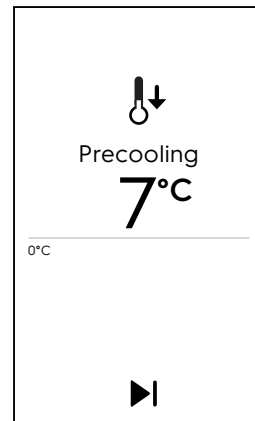

Precooling and preheating functions prepare the cavity temperature before the beginning of the selected cycle.

▶ Skip Precooling/Preheating

Skip the preparation and go immediately to the main cycle.

- At the end of Precooling/Preheating:

- Insert the food in the appliance and close the door to start the cycle (TIME CYCLE);
- Insert the food in the appliance, the food probe in the product and close the door to start the cycle (PROBE CYCLE);

At the end of the cycle, an acoustic signal is activated and a pop-up window opens showing the following message:

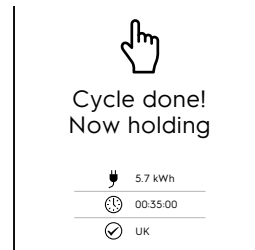

🔌 Energy consumption in kWh

🕒 Time duration in hours : minutes : seconds

✓ Reference standard used (for example UK)
The check with the standard is successful

✗ Reference standard used (for example UK)
The check with the standard is not successful

Touch the X to close the pop-up window.

- The appliance keeps holding.
(only if the cycle provides for holding phase)

If it is necessary to change some default parameters in the cycle proceed as follows:

- Change or disable Reference Standards (Norms)**

If a reference standard changes, time and temperature values change.

To switch the reference standard, proceed as follow:

- Open lower drawer;

- Select Norms icon and choose the required reference standard, moving with the arrows;

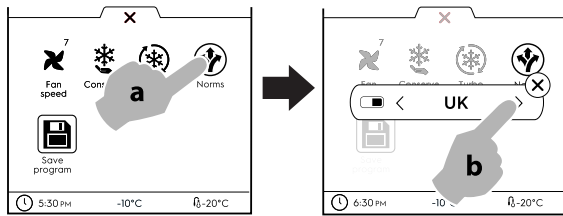

- Touch the X to confirm and close the pop-up window. There are two ways to disable the Norms:

a. from lower drawer

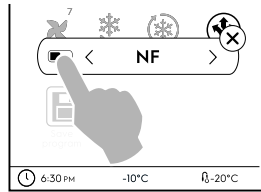

b. from Settings mode (see chapter F.13 Settings mode).

• **Change/Set the TEMPERATURE**

- Touch the row of the temperature value; select the required temperature on the numeric keypad, choosing between Soft or Hard options.

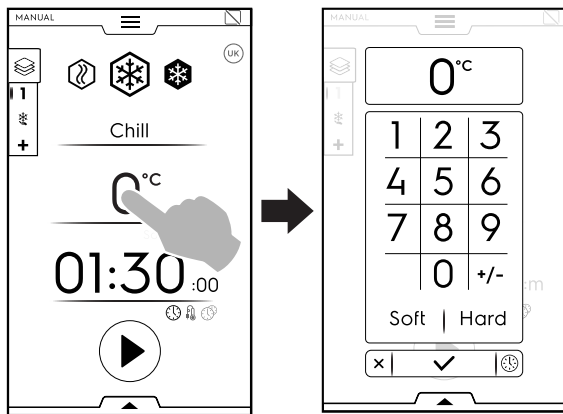

a. Soft option

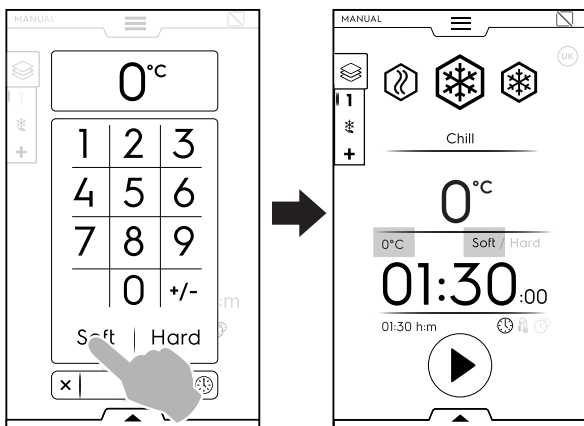

b. Hard option

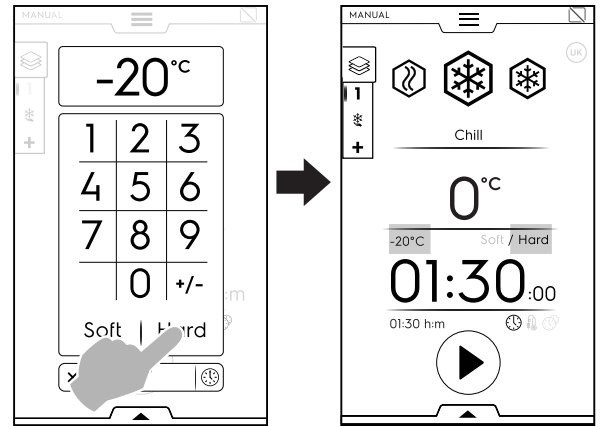

NOTE!

The numeric keypad allows to go directly to time options without coming back to the first page of Manual mode.

Touch the button as illustrated in the figure to access Time options:

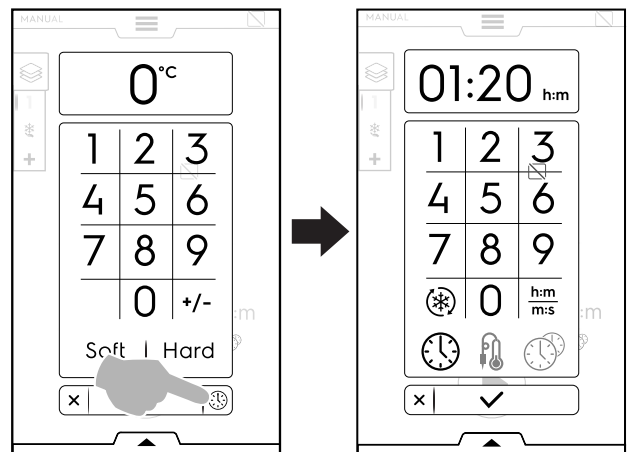

• **Change/Set the duration TIME**

- Touch the row of the time value; set the new value on the numeric keypad.

The default visualisation is in hours and minutes (h:m).

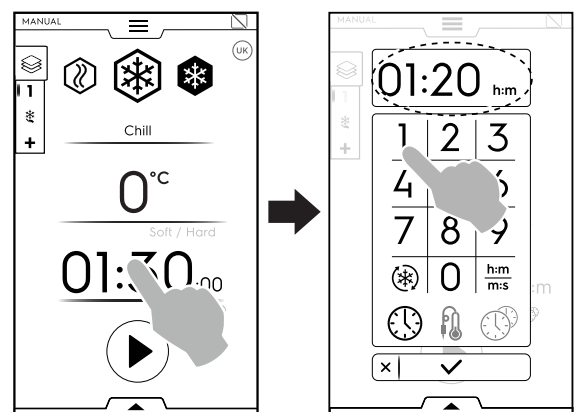

Turbo Cooling cycle

Displayed time

Probe cycle

MultiTimer

DISPLAYED TIME

It converts minutes into seconds.

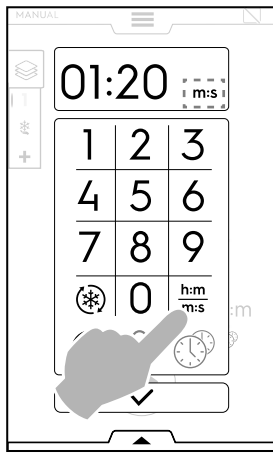

TURBO COOLING

The icon is shown in chill and freeze cycles and represents a shortcut to Turbo Cooling cycle.

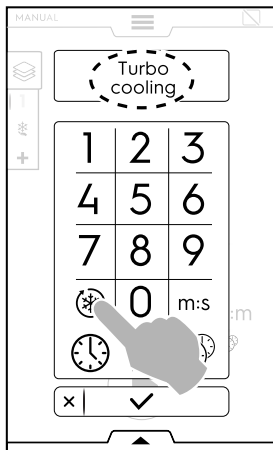

The appliance works with infinite time.

When the cycle is active, it is possible to deactivate it by touching the icon again.

Turbo cooling cycle can be activated also from the lower drawer. (see paragraph **LOWER DRAWER** in chapter F.7 Drawers area).

In Hot and Holding cycles the pop-up window shows the infinite

icon  instead of Turbo cooling icon.

PROBE CYCLE

The core probe allows precise measurement of the exact core temperature of the food during a cycle. This option excludes the time cycle setting.

To set a probe cycle proceed as follow:

- Touch the time or probe icon in the main page and select the CORE PROBE option;

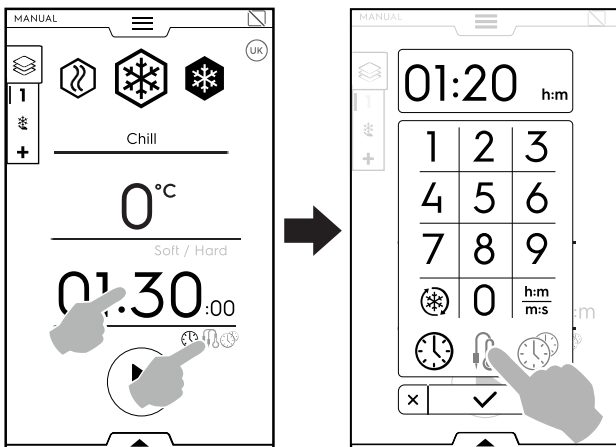

If a Reference Standard is selected, it is not possible to change temperature parameters.

The end-of-cycle set is required by the reference standards; to modify it, disable norms.

In case of a multiphase cycle, the Reference Standard is applied only in the last phase. The intermediate phases can be modified.

- Touch the button .
- Precooling (or preheating) starts.
- At the end of precooling (or preheating) open the door and remove the food probe from its seat.



NOTE!

Make sure the core probe is cleaned and sterilised when inserting it in the product.

- Insert the core probe in the product without forcing excessively and close the door to start the cycle.

Make sure the tip (the sensitive part) is positioned. It is important to place the core probe correctly near the center of the product, making sure the tip does not protrude and, in particular, that it does not touch the pan.

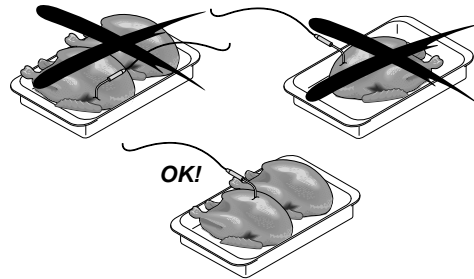

If the core probe is not inserted or is inserted wrongly, after some minutes a pop-up window opens showing the message the cycle is going to be driven by time in order to not corrupt the process.

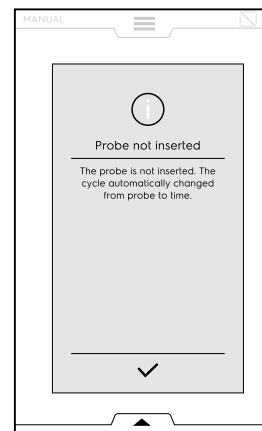

- At the end of the cycle, open the door and remove the core probe, putting it back in its original position.

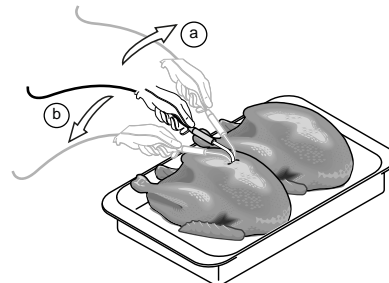

NOTE!

Remember that the pans are cold, therefore use gloves

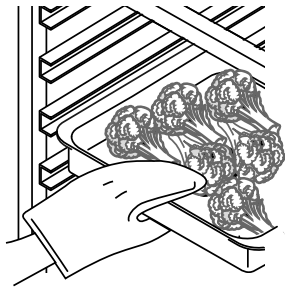

PRODUCT LOADING

It is advisable to keep food covered during the cycle in order to facilitate chilling. The product must be evenly distributed inside the compartment to ensure good air circulation and therefore better preservation. In any case, do not leave the door open longer than necessary when removing or loading food.

It is advisable to use shallow containers to allow good air circulation around the product (the greater the surface area of the food exposed to the cold air, the shorter the chilling time). Clean the containers and their support surfaces thoroughly to avoid contaminating the food. It is also advisable to put the food in the chiller using the same container it was cooked in.



NOTE!

The appliance can be operated with MULTIPROBE accessory (up to three independent probes) or USB probe accessory. To enable the accessories see chapter F.13 *Settings mode*.

Select the most appropriate probe and enter the core probe temperature on the numeric keypad;

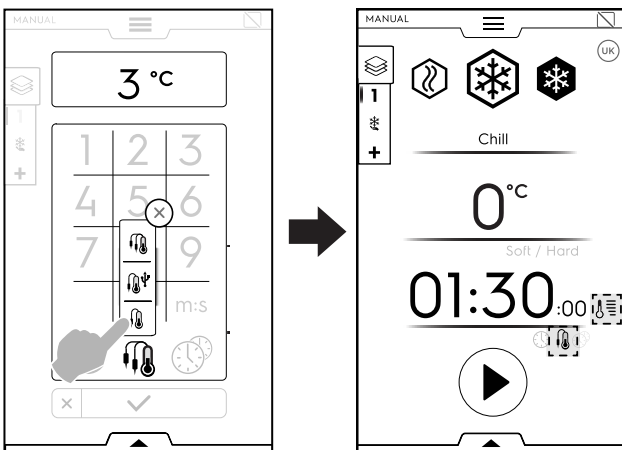

Adjustable PROBE to measure the product core temperature



Adjustable PROBE for data transmission on USB pendrive (accessory)
To enable USB probe accessory see chapter F.13 *Settings mode*.



MULTIPLE PROBE (accessory)
To enable Multiprobes accessory see chapter F.13 *Settings mode*.

How to use MULTIPLE PROBE accessory

- Touch probe icon.
A pop-up opens showing the list of all probes available.

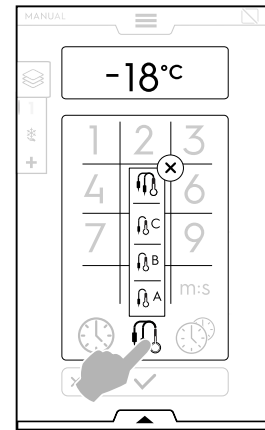

- Select the required probe (for example probe A),

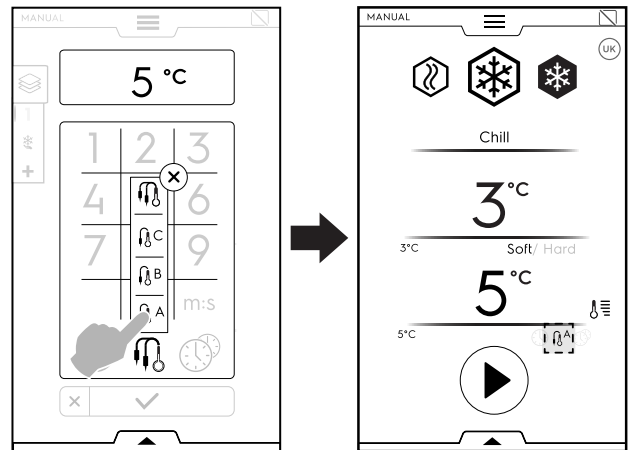

or multiprobes icon, to use all the available core probes.

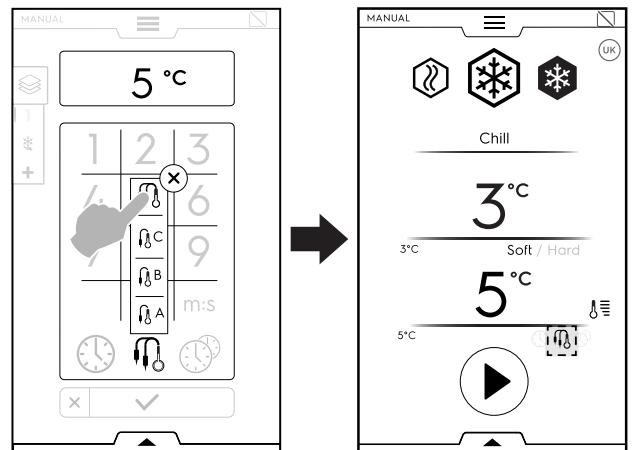

During the cycle it is possible to visualise probe temperature by

touching the icon ;

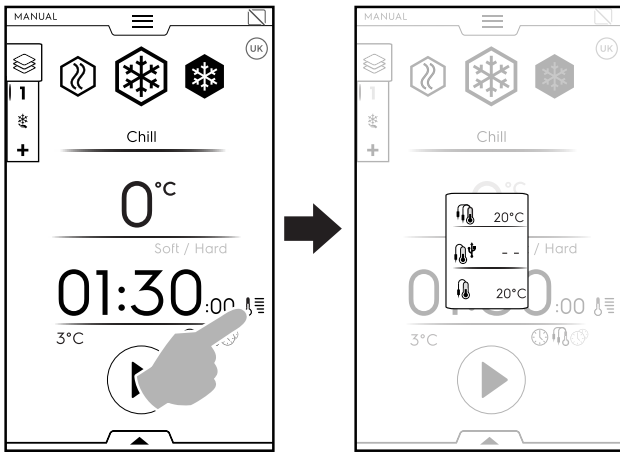

The cycle ends when all the probes reach the set value.

MULTITIMER

With the MultiTimer system it is possible to set a different time for each recipe (chicken, potatoes, etc.) or for each pan placed on the various levels, (level 1 for the top pan, next levels for lower pans).

This function also allows the blast chiller to be used with an "à la carte" menu where the food can be placed in the appliance at the required time during the same cycle.



NOTE!

This function cannot be selected in a multiphase cycle.

To set Multitimer proceed as follow:

- Select Multitimer and confirm.

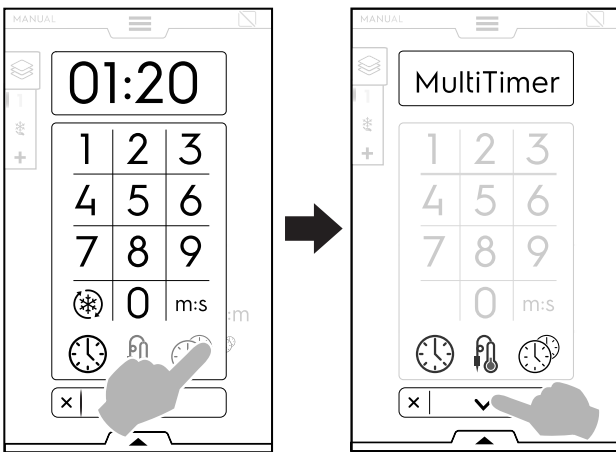

- A pop-up window opens. Touch the left part of a row to create a new preset, type the new name on the keypad and confirm.

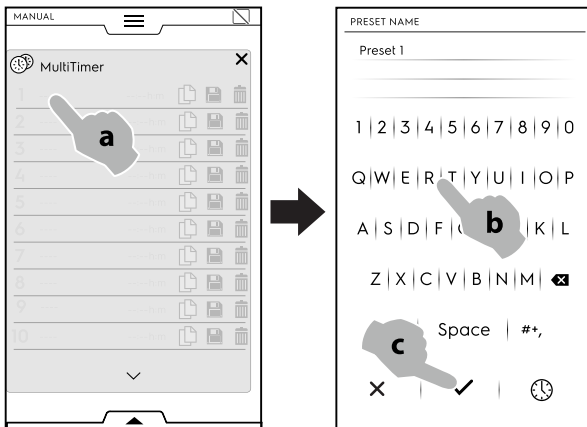

- Set preset duration or food core temperature. There are two ways to do it:

- Touch time icon on the keypad;

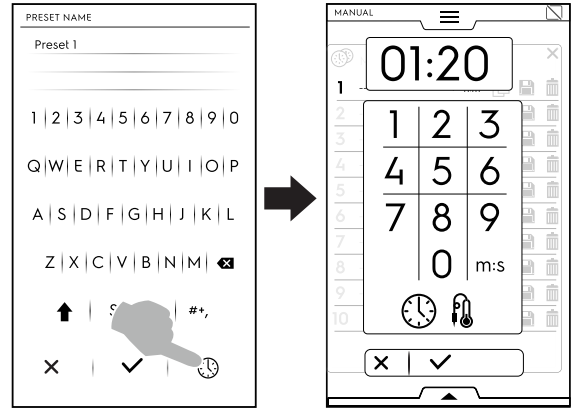

- Touch time area on the right part of the row;

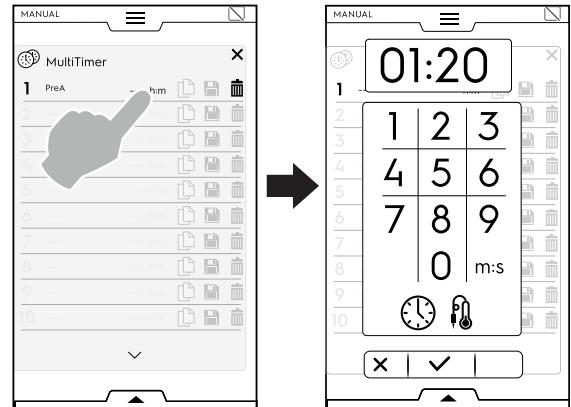

- The appliance shows the most similar presets or the presets compatible with the just set preset. Touch the left part of each rows to recall them and select the required one.

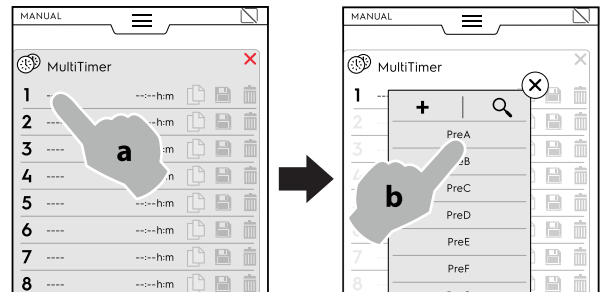

- Touch "+" to create and add a new preset. It is possible to add up to 20 presets.

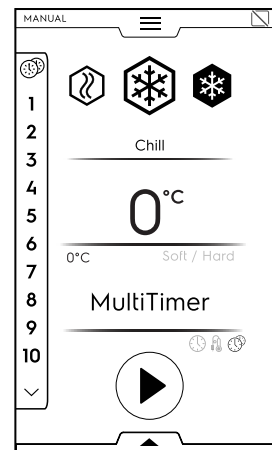

- After having added the required presets, the icons on the right become available.

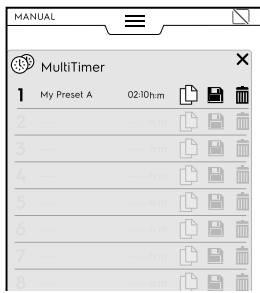

Now it is possible to:

- Duplicate the Preset
- Save the Preset (available only for new presets)
- Delete the Preset

Additional actions on the program can be done through the lower drawer. Open the lower drawer to:

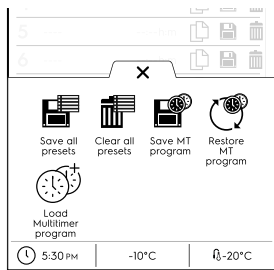

- Save all presets (save all preset instead of saving them one by one)
- Clear all presets (delete all presets instead of deleting them one by one)
- Save MT program (save all the presets as a MultiTimer program)
- Restore MT programs (it is available only in a Multitimer program. It allows to restore the deleted presets of a MT program)
- Load MultiTimer program (it is available only in a Multitimer program. It allows to load a Multitimer program from Program mode)

- Touch the button to start the cycle.
- Precooling (or preheating) starts.
- At the end of cavity preparation insert the food in the appliance, the core probe in the product (when needed) and close the door to start the cycle.

The display shows up to three presets: the remaining time (or the current food core temperature) and the name, when present. The presets are ordered from top to bottom according to minimum and maximum remaining time.

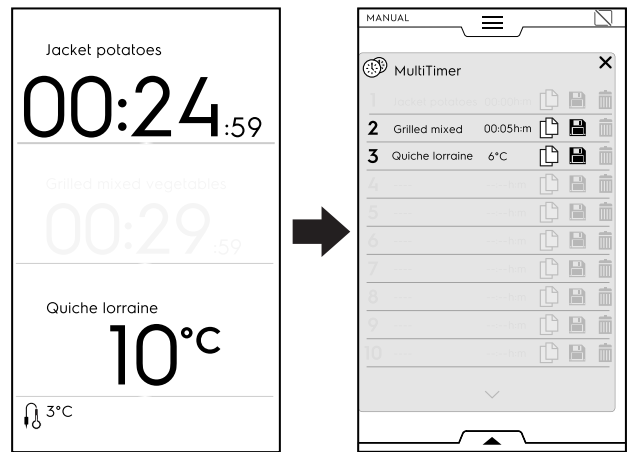

- When a preset ends, some acoustic signals sound. The display shows the Multitimer page list with the ended preset blinking in green.
- Open the door and remove food. After closing the door, the ended preset disappears from display.

NOTE! During a preset it is possible to add other presets. The preset reference number blinks while the door is open to insert the food in the appliance. When the door is closed again the preset reference number stops blinking.

- When the last preset ends and the food is removed, hold down the button to stop the preset cycle.

F.8.2 Multiphase drawer

Food can be chilled, frozen or cooked in different phases. The appliance enables programmes consisting of several sequential phases. During a program, going from one phase to the next occurs automatically. The program automatically stops when all phases are completed.

- To set the multiphase program proceed as follow:
1. Set first a cycle, (refer to F.8 Manual mode paragraph);
 2. Add new phase;

There are two ways to add a phase:

- a. Touch the “+” icon in the Drawer Multiphase.

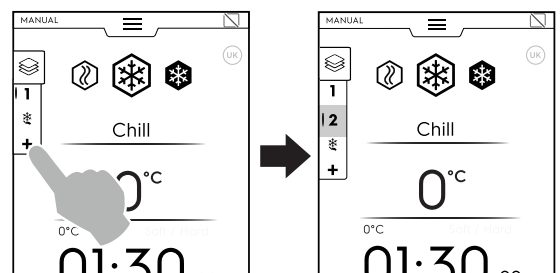

The appliance adds default phases. Touch the Multiphase Drawer to check the phase list.

Touch each phase row to assign new parameters.

- b. Open the Drawer Multiphase and touch the “Add phase” icon.

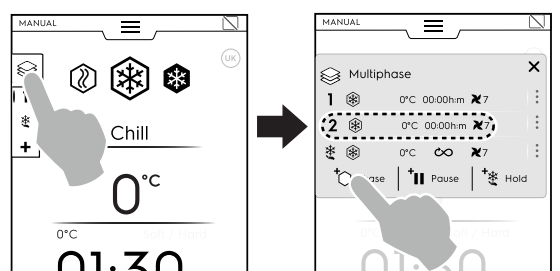

Touch the phase row to set the parameters of the new added cycle.

Add Pause

Touch the icon to add Pause phase.

Add Hold

Touch the icon to add manually a holding phase.

In this case the holding phase will be positive with 1 hour duration.

It is possible to add **Turbo cooling cycle** only as last phase.

When Turbo cooling cycle is added, the automatic Holding cycle disappears and it is not possible to add other phases.

Select "Turbo cooling" icon on the keyboard to add a Turbo cooling phase.

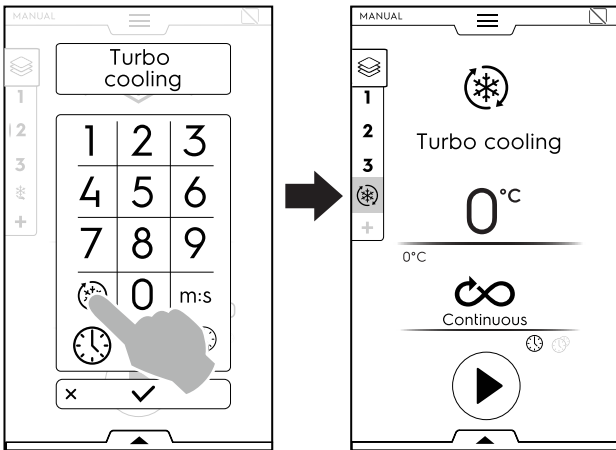

It is possible to add maximum 15 phases + Hold phase.

NOTE!
The HOLD phase appears always at the end of the list and cannot be moved and copied.

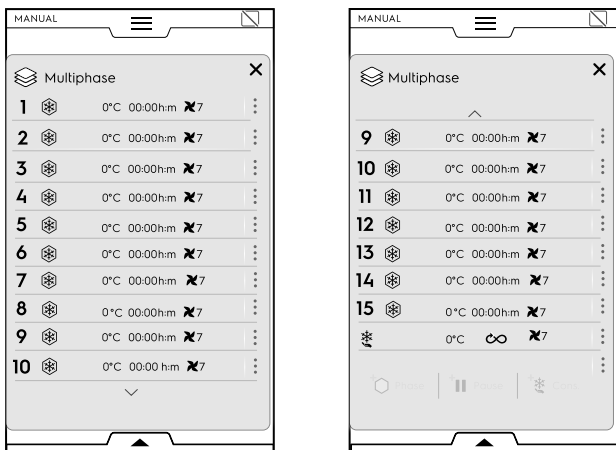

3. Set the parameters of the new added cycles and start.

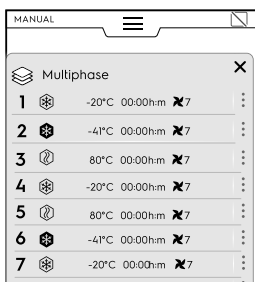

The running phase is highlighted in green. The phases in grey in the list are already being performed.

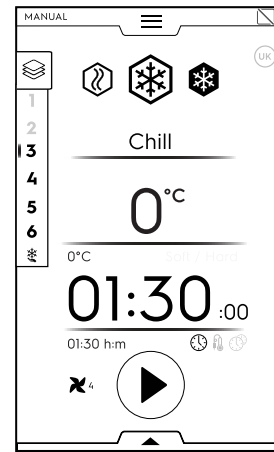

NOTE!
If a Lite Hot cycle is inserted as last phase, holding cycle is automatically disabled. It is possible to enable holding cycle manually.

Phases management:

- Touch the 3 dots on the right to open the mini pop-up with Messages, Move, Duplicate, Delete functions.

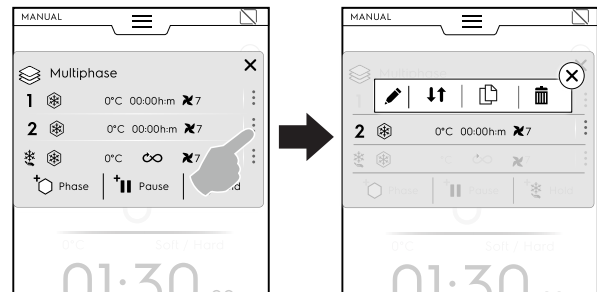

NOTE!
The pop-up opens only if the cycle has not started yet.

- Touch the red cross to close the mini pop-up.

Messages

Touch this icon to write messages between phases.

Move phase

Touch this icon to change the position of the phase.

The other phase numbers start blinking.

Touching the required phase number to select the new position.

Delete phase

Touch this icon to delete immediately the phase.

Duplicate phase

If there is only one phase, it is not possible to move or delete a phase but only Duplicate.

SKIP FUNCTION (available during a running programme only):

- Touch the three dots on the right of the selected phase to open the mini pop-up with Skip function.

NOTE!
The pop-up opens only if the cycle has already started.

- Touch Skip icon to leave the current phase and start immediately the selected phase.

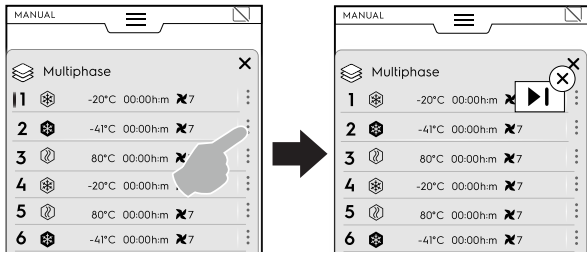

Lower drawer functions

Further actions can be done through the lower drawer:

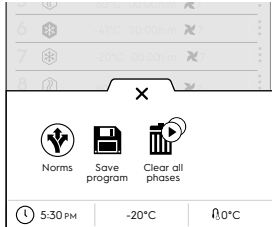

Norms
(in a multiphase cycle with different phases, the regulations are not applied)

Save program

Touch this option to save and store customized cycles in Program mode. Type a name on the numeric keypad to be assigned.

Clear all phases

Touch this icon to delete all the phases in the Drawer Multiphase and start again from phase 1.

Before clearing the phases in the drawer, a pop-up window opens up asking for confirmation.

F.9 Automatic mode

“Automatic” mode is a fast simple way to choose the perfect automatic chilling, freezing or Lite Hot process, just setting a few simple functions.

How to set an automatic cycle

1. Open the upper drawer and select Automatic mode.

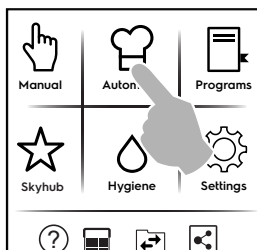

2. Select a food family.



3. Select the category food and the required associated preset;

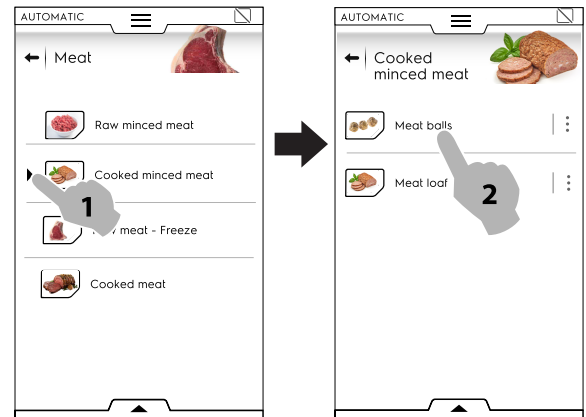

Each category may have more presets associated with it.

4. Select the required preset and, if needed, set the parameters.

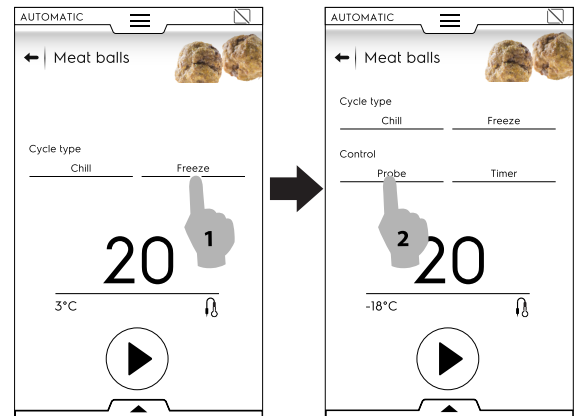

If necessary set temperature or time touching on temperature and time zone.

Some cycles are entirely automatic.
The display shows that no parameters can be set.

- Once modified the cycle with the new parameters, it is possible to save it as a preset;

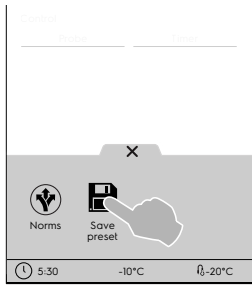

- Touch the icon to save the preset;
 - A pop-up window opens showing the message to overwrite the preset;
 - Touch the ✓ to confirm or touch X to save a new preset.
- Touch the corresponding button to start the cycle.
 - Precooling/Preheating starts.



NOTE!

During the cavity preparation it is still possible to make other changes on the parameters.

- At the end of precooling/preheating insert the food in the cavity, the core probe in the product (when needed) and close the door to start the cycle.
- Sensing/Temperature recovery function starts. These functions analyze the appliance cavity conditions to optimise the cycle according to the type and load of food.

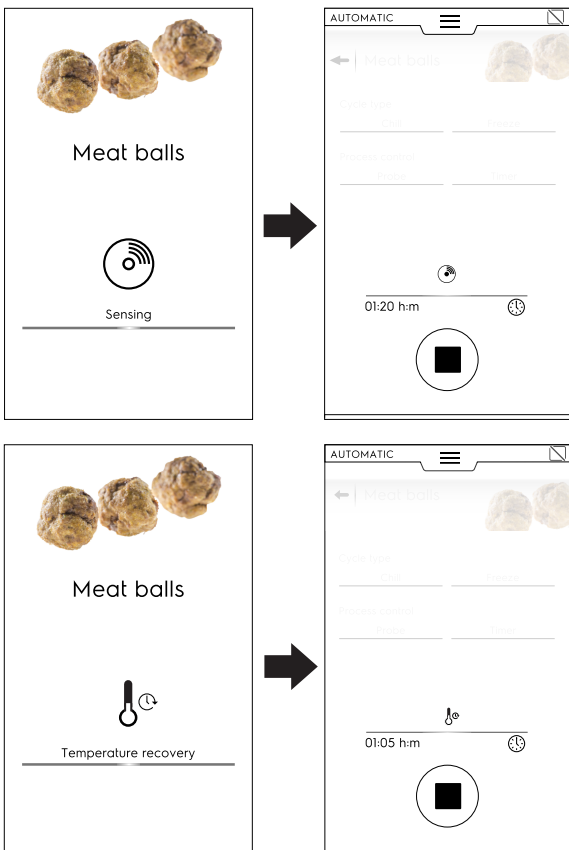

- Once Sensing/Temperature recovery phases end, a screen saver related to the cycle approach (time or food core temperature) appears during the cycle. In any case it is possible to customize the screen view by means of the bottom drawer. Open it and choose the most suitable one.

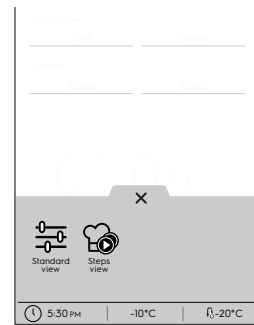

Standard view



Steps view

- At the end of the cycle the display shows the following information:

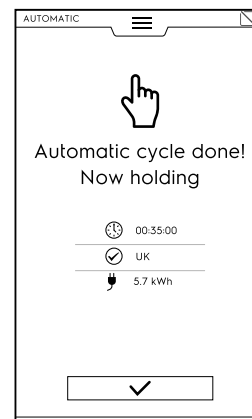

Time duration in hours : minutes : seconds



Reference standard used (if enabled)
The check shows if the standard is successful.



Reference standard used (for example UK)
The check with the standard is not successful



Energy consumption in kWh

F.9.1 Cycles+/Special cycles

This section contains special cycle approaches designed to obtain specific results.

Touch the icon  to visualize a list of special cycles.



Cruise chilling

Cruise cycle automatically adjusts (by an algorithm) the chilling cycle according to food size while monitoring the process from start to finish. Chilling is automatically controlled from start to finish ensuring perfect food quality, texture and appearance.

The only cycle mode available is a chill cycle with core probe;

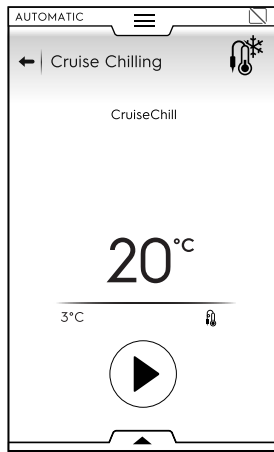

It is possible to set probe parameters only if standards are disable.

Proving

The appliance works like a proving cabinet, to prove any pastry or bakery product.

To start the cycle proceed as follow:

1. Select Proving cycle;
This cycle is performed as a Lite Hot cycle.

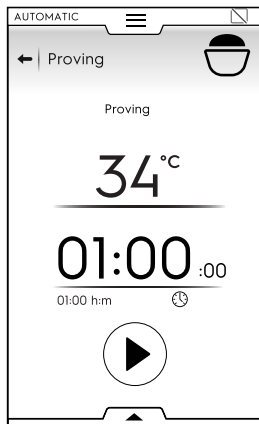

2. If needed set the parameters;
It is possible to save and store the performed presets from the lower drawer;

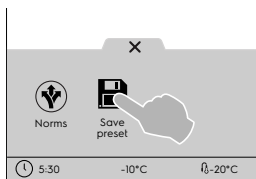

3. Touch Start button;
4. When cavity preparation is finished, insert the food in the cavity, close the door and the cycle starts.
5. At the end of the cycle, if available, the display shows the consumptions as a recap message.

Retarded Proving

The appliance works like a proving cabinet to retard proving any pastry or bakery product.

To start the cycle proceed as follow:

1. Select Retarded Proving cycle;

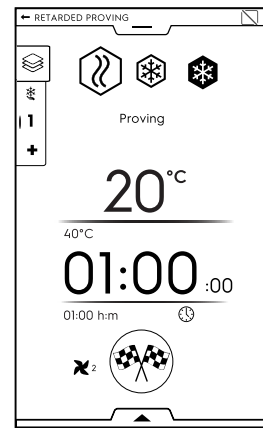

2. If needed set the parameters;

3. Touch the  button.

The display will show an edit page to set the time in which the product must be completely risen (for example at 18:00 PM)

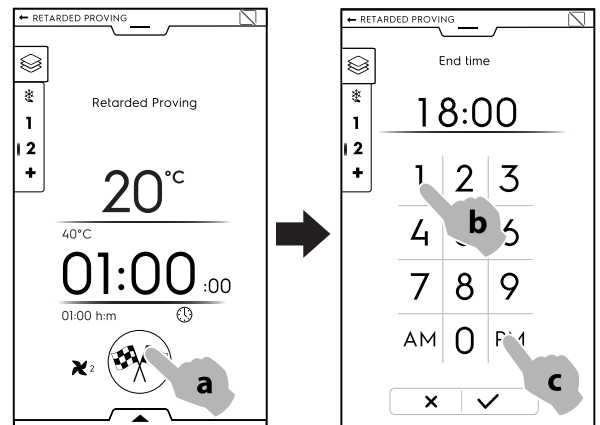

4. Confirm the setting.
5. The cycle starts with Holding phase;



NOTE!

The duration of the holding phase is automatically calculated by the appliance.

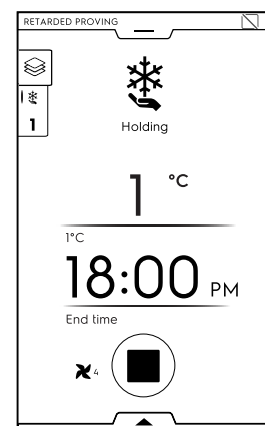

6. At the end of holding phase, proving cycle starts;

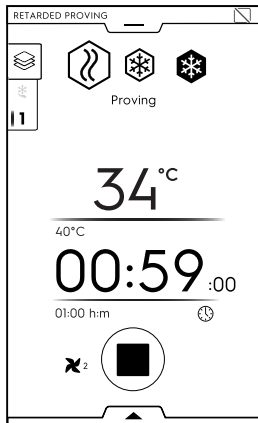

7. At the end of the cycle, if available, the display shows the consumptions as a recap message.

❄️ Fast thawing

Fast Thawing cycle guarantees that frozen food is thoroughly thawed and ready to be cooked.

To start the cycle proceed as follow:

1. Select Fast thawing cycle;
2. Select the required preset;

This cycle is performed as a multiphase cycle.

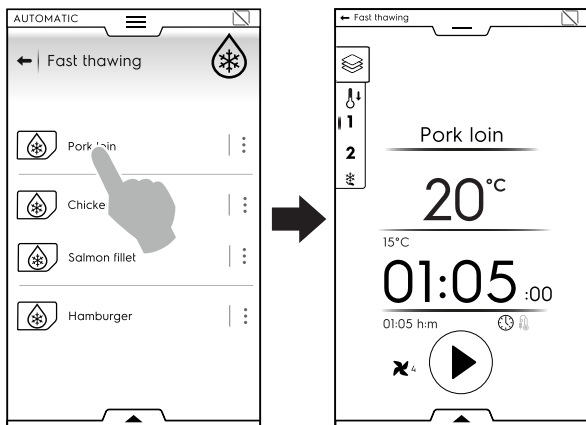

3. If needed set the parameters;

It is possible to save and store the performed presets from the lower drawer;

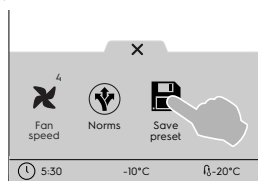

4. Touch Start button;
5. When cavity preparation is finished, insert the food in the cavity, the core probe in the food (if it has been set a probe cycle), close the door and the cycle starts.
6. At the end of the cycle, if available, the display shows the consumptions as a recap message.
7. The appliance keeps holding.

🍣 Sushi&Sashimi

This cycle allows to freeze fish at -24°C for 24 hours (cavity works at -40°C). In this way the parasite of anisakis are killed. This cycle is performed as a multiphase cycle available only with core probe.

It is possible to choose between two factory presets:

- Freeze to preservation;
- Ready to serve;

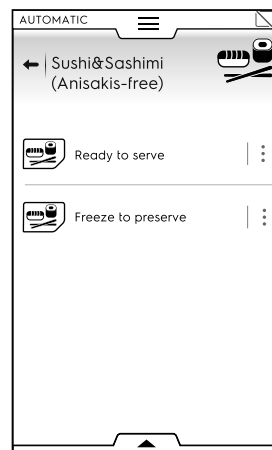

Freeze to preservation consists of 3 phases: Freeze – Sanification – Holding (negative).

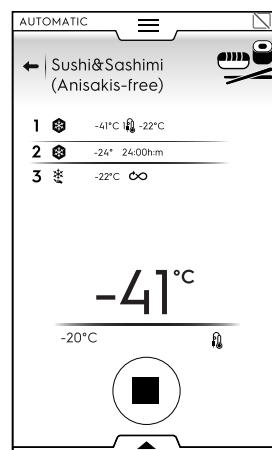

Ready to serve consists of 5 phases: Freeze – Sanification – Thawing – Thawing – Holding (positive).

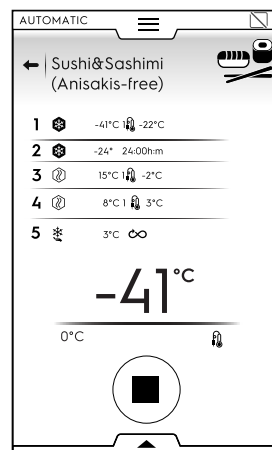

To start the cycle proceed as follow:

1. Select Sushi&Sashimi cycle;
2. Select the required preset;
3. Touch Start button;
4. When cavity preparation is finished, insert the food in the cavity, the core probe in the food, close the door and the cycle starts.
5. At the end of the cycle, if available, the display shows the consumptions as a recap message.
6. The appliance keeps holding.



IMPORTANT

If the core probe has not been inserted, the cycle changes automatically from probe to time. In this case the sanitation could not be guaranteed.



Sous-vide chilling

This cycle is specific for chilling food previously sous-vide cooked.

This cycle is performed as a chill cycle.

To start the cycle proceed as follow:

1. Select Sous-vide chilling cycle;
2. If needed set the parameters;
It is possible to save and store the performed presets from the lower drawer;

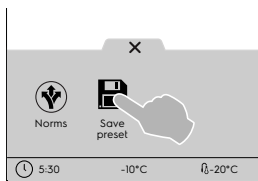

3. Touch Start button;
4. When cavity preparation is finished, insert the food in the cavity, close the door and the cycle starts.
5. At the end of the cycle, if available, the display shows the consumptions as a recap message.
6. The appliance keeps holding.

Ice-cream

It allows to preserve the ice-cream right after production and prepare the ice-cream to be displayed.

This cycle is performed as a freeze cycle with core probe.

To start the cycle proceed as follow:

1. Select Ice-cream cycle;
2. Select the required preset;
It is possible to choose between three factory presets:
 - Freeze to Holding
 - Holding
 - Ready to display

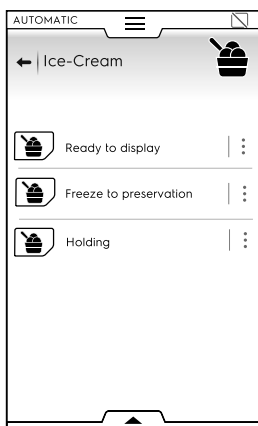

3. If needed set the parameters of the probe;
It is possible to save and store the performed presets from the lower drawer;

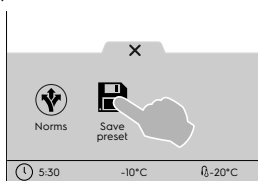

4. Touch Start button;
5. When cavity preparation is finished, insert the food in the cavity, the core probe in the food, close the door and the cycle starts.
6. At the end of the cycle, if available, the display shows the consumptions as a recap message.
7. The appliance keeps holding.

Yogurt

It allows to obtain up to 6 kg of yoghurt, starting from 100 grams container.

To start the cycle proceed as follow:

1. Select Yogurt cycle;
This cycle is performed as a multiphase cycle (lite hot – Chill – Holding)
2. If needed set the parameters;
It is possible to save and store the performed presets from the lower drawer;

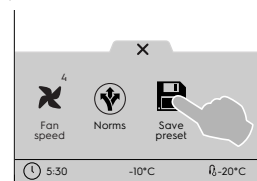

3. Touch Start button;
4. When cavity preparation is finished, insert the food in the cavity, close the door and the cycle starts.
5. At the end of the cycle, if available, the display shows the consumptions as a recap message.
6. The appliance keeps holding.

Chocolate

It allows to get perfectly melted or crystallized chocolate.

To start the cycle proceed as follow:

1. Select Chocolate cycle;
2. Select the required preset;
It is possible to choose between several factory presets performed with different cycles:
 - Crystallisation bars and ganaches;
 - Crystallisation shells;
 - Freeze;
 - Holding;
 - Melting;

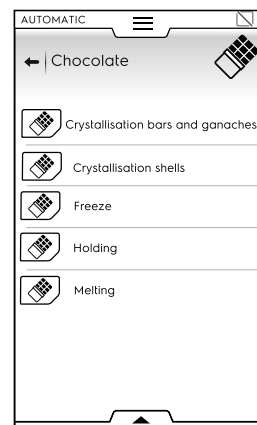

3. If needed set the parameters;
It is possible to save and store the performed presets from the lower drawer;



4. Touch Start button;
5. When cavity preparation is finished, insert the food in the cavity, close the door and the cycle starts;
6. At the end of the cycle, if available, the display shows the consumptions as a recap message;
7. The appliance keeps holding.

F.10 Programs mode

The “Programs Mode” allows to recall program recipes already stored or downloaded from cloud and/or create and store new ones.

How to set a program cycle

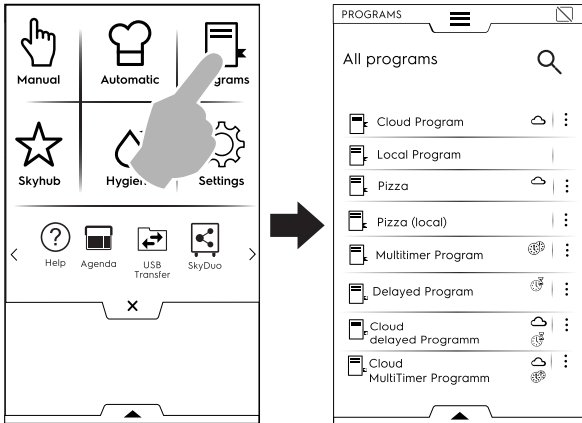

1. Select Programs mode. The display shows all stored programs.

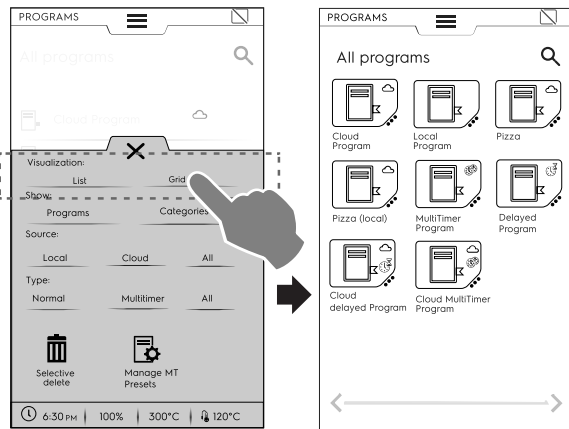

To change the programs displaying from a list to a grid open the lower drawer and select grid visualization:



When displaying the programs, the appliance gives you a general information about the type of program and its source:

-  Program downloaded from cloud (available only with connectivity devices, installed by specialised personnel)
-  MultiTimer program
-  Program with delay start

2. Touch the required program; The appliance loads the program in Manual mode ready to be launched.



NOTE!

To search a program touch icon  and digit the name on the appearing keypad. The display will show the programs most similar to the one you typed.

How to create and save a program

- Select a cycle in Manual mode and if necessary set the parameters (see chapter F.8 *Manual mode*).
- Open the lower drawer and touch “Save program” icon.

- Edit the program name on the keypad and confirm.

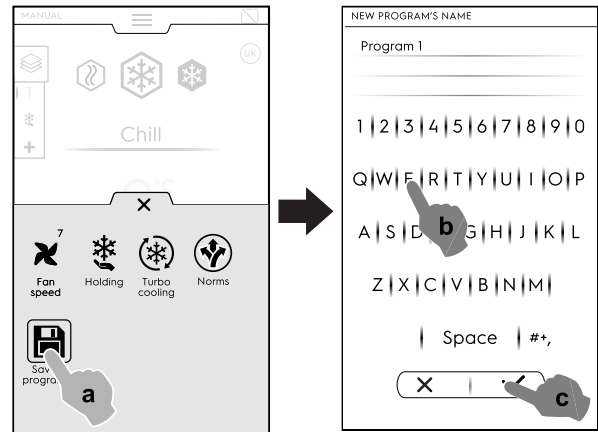

- The new program will be stored in Programs mode.

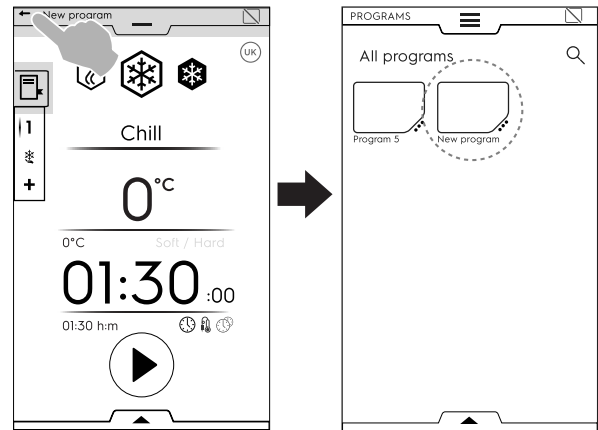

IMAGE, NAME, CATEGORY LINK AND DELETION OF STORED PROGRAMS

1. Touch the 3 dots near the program icon to access the “features management” menu;

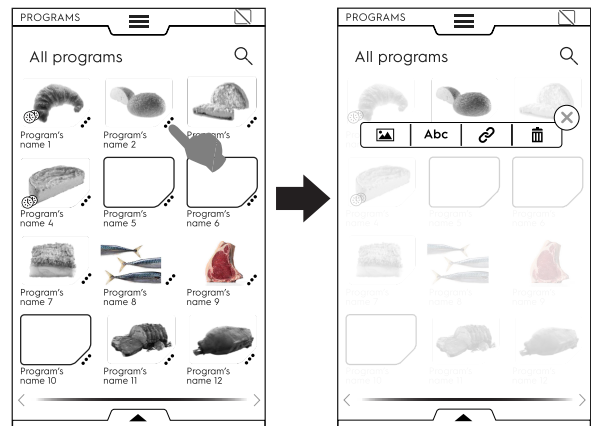

CHANGE IMAGE

- Touch the image icon to change the default image; Choose the required image and confirm it.

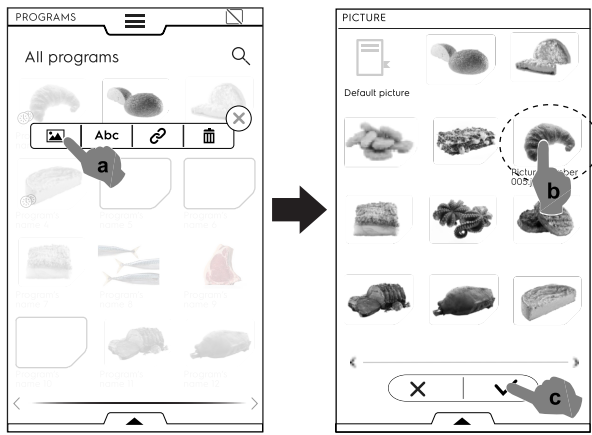

EDIT NAME

- Touch "abc" icon to edit the programme name; Type the new name and confirm it.

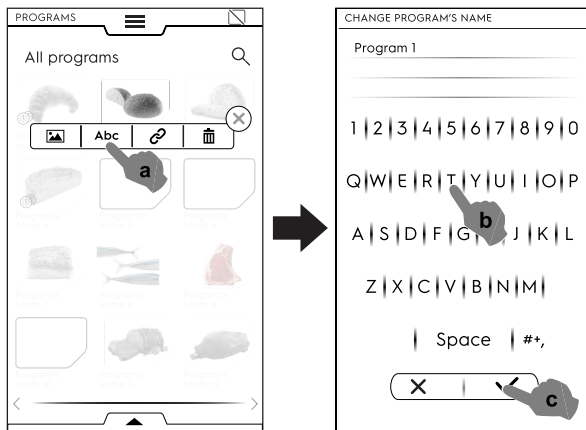

LINK TO CATEGORY

- Touch link icon to associated the program to a category;

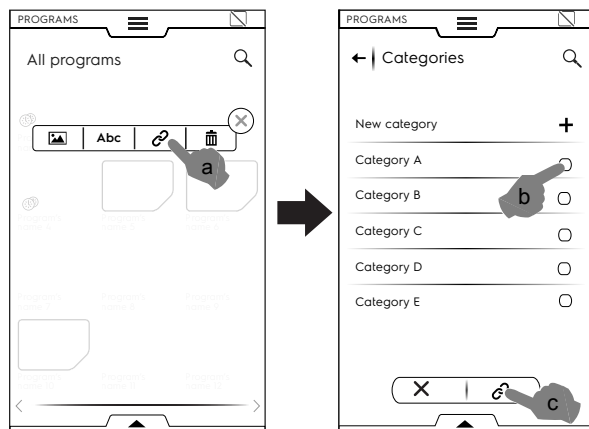

Once a category is selected, touch the link button.

DELETE PROGRAM

- Touch the recycle bin icon to delete a program and confirm;

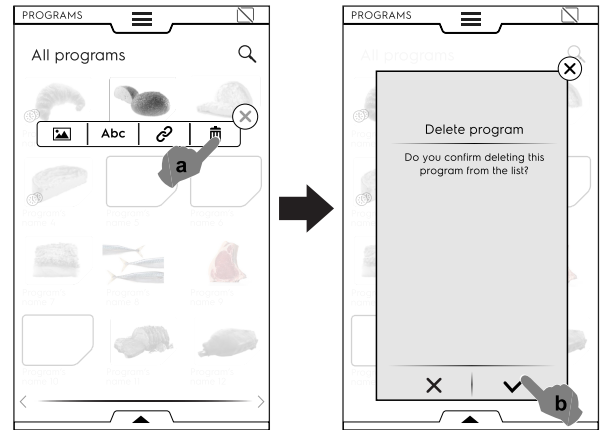

Programs management through lower drawer

Open the lower drawer and:

- select "Programs" to see the list of all programs;

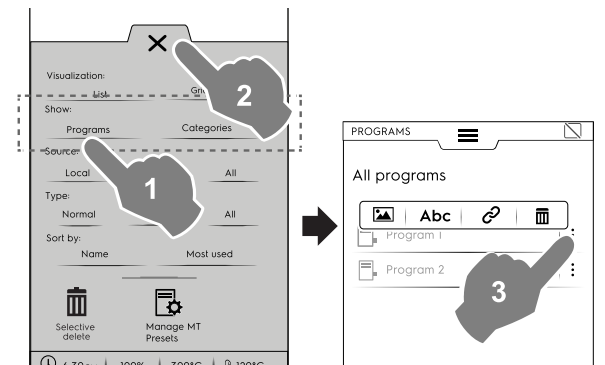

NOTE! For all programs displaying, the three vertical dots on the right side of the selected program open a popup window that allows to add a picture, rename the programme, link it to a category and delete it. Always touch **X** to close the drawer.

- select "Categories" to see the list of all categories; Each category expands showing the linked programs.

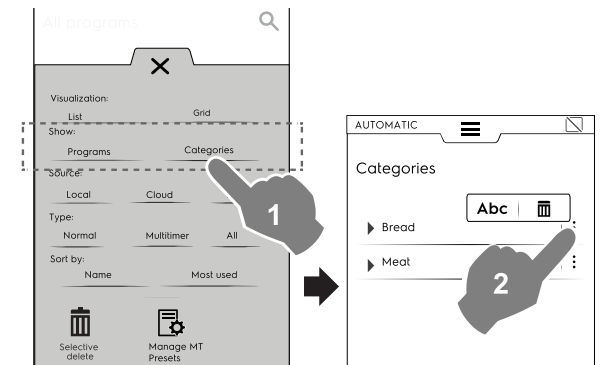

- select "Local", "Cloud" (available only with connectivity devices, installed by specialised personnel), or "All" to display the programs by their source or to display all programs;

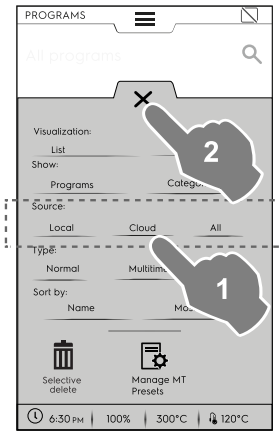

- Select the programs to be deleted or open the drawer again and select:

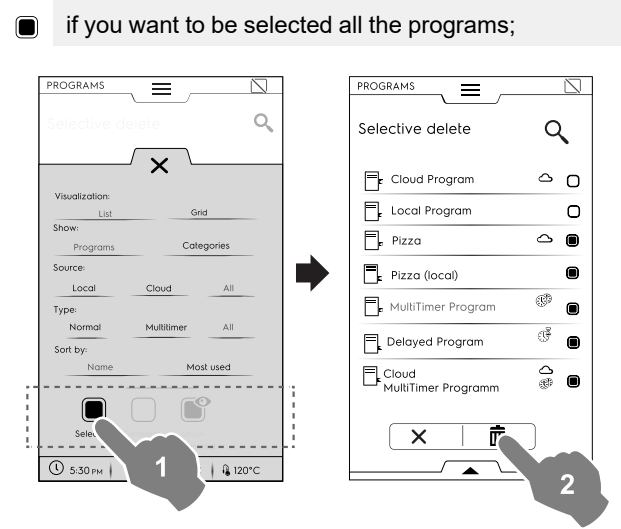

- select "Normal", "MultiTimer", or "All" to display the programs by their type;

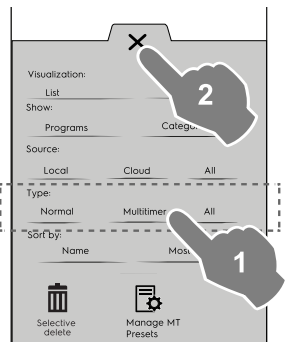

or select one of the following options:

- if you want to be deselected all the programs;
- if you want to display only the selected programs;

Always close the drawer to see applied your selection on the display.

Manage MT Presets

It is possible to rename/delete the Presets and display the information associated to the program which includes them.

- Touch the corresponding icon.

- select "name" or "Most used" to sort the required programs;

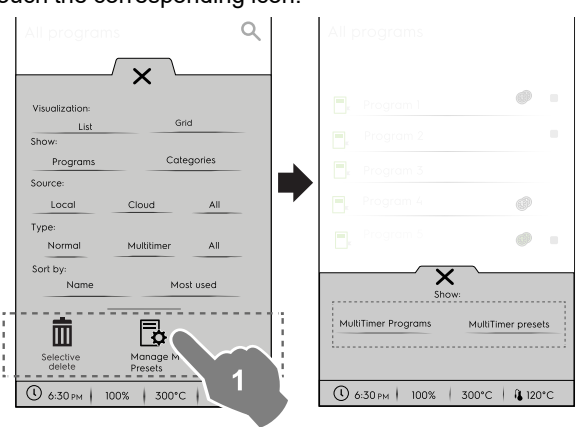
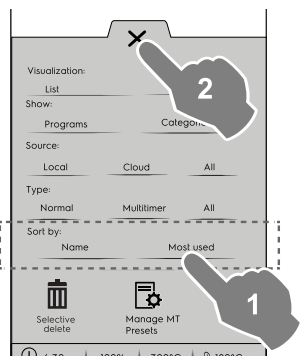

Selective delete function

- Open the drawer to select the programs to be deleted. The list of the programs appear on the display.

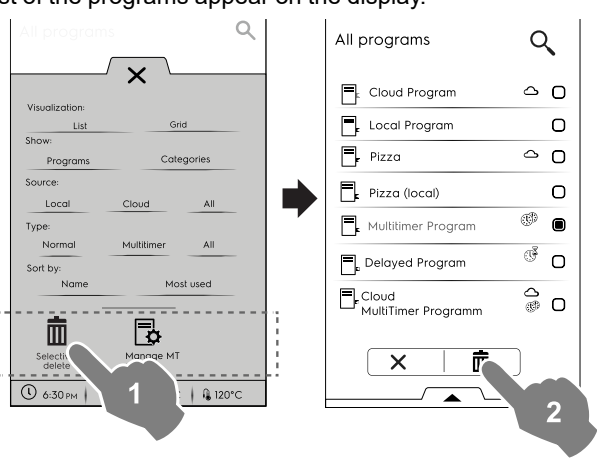

- Select a program of the list and touch button to start it;



NOTE!
Once recalled the program, it is still possible to modify it by adding more phases or more presets.

Adding phases to a program

- Touch the Multiphase drawer to display all the phases composing the entire cycle;
- Add more phases (see F.8.2 *Multiphase drawer* paragraph);

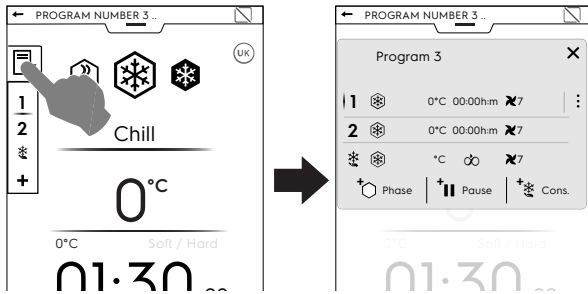

- Open the lower drawer and save the program;

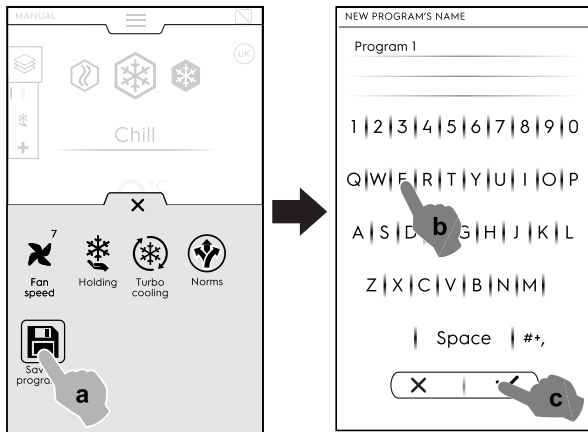

Adding presets to a Multitimer program

- Touch the Multitimer drawer to display all the presets linked to a programme;
- Add more presets (see "MultiTimer" paragraph in chapter F.8 *Manual mode*);

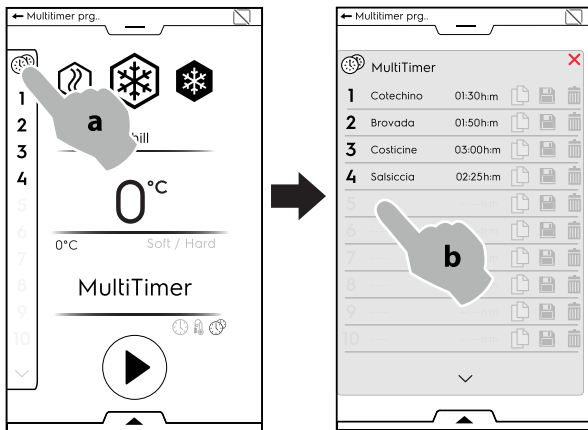

- Open the lower drawer and save the program.

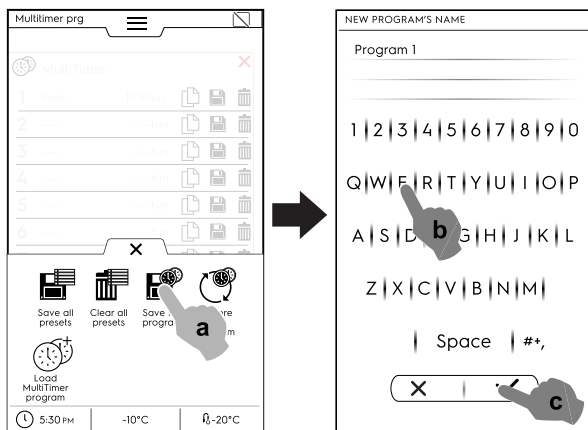

F.11 Homepage mode (SkyHub/SoloMio)

This mode is a repository of links to the most used features of the appliance and allows to customize the display menu according to your needs.

- Select SkyHub mode;

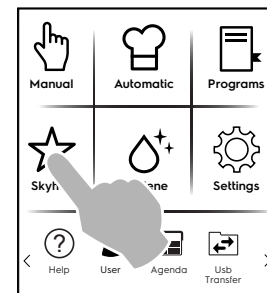

- The first time you access the menu, all items are empty. You can create a folder containing the most used features or a direct link to your favorite feature.

Touch "+" to add a folder or the required function;

Creating a folder

- Touch "+" and select ;

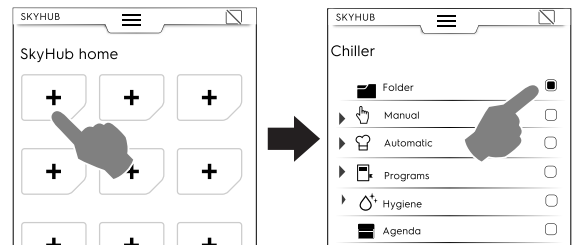

- you are requested to give immediately a folder title and to choose a picture from the proposed ones.

It is possible to rename, associate another picture or delete the folder anytime.

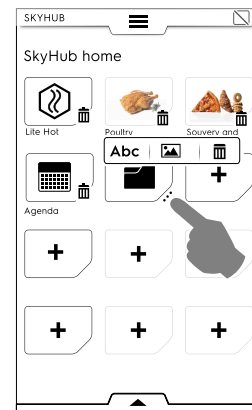

Adding a link

- Select the required function (for example Lit hot cycle in Manual mode);

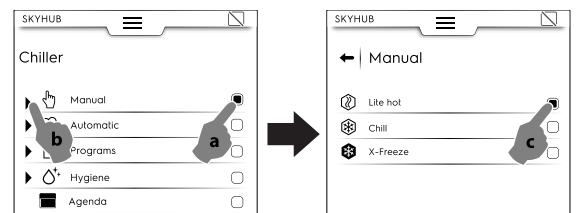



- To delete a function touch the icon  at the bottom corner.



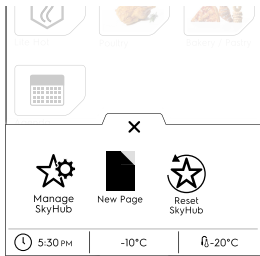



- To save your favourites open the lower drawer and touch "Manage SkyHub" icon. The green icon becomes white. The display goes out from the EDIT menu and goes back to the favourites list.

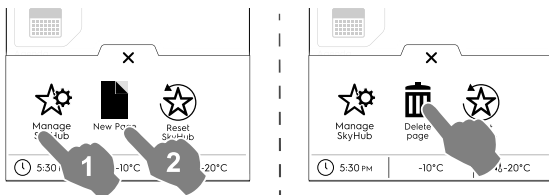

Other features

- To create more pages:
 - Touch  and then  icons.



- To save the new page touch  again. The icon becomes white.
- To delete a new page touch the corresponding icon .
- To delete all links, folders and pages touch .

F.12 Hygiene mode

Hygiene function allows to sanitize the appliance cavity automatically choosing the most suitable program.

1. Select Hygiene cycle from the upper drawer;

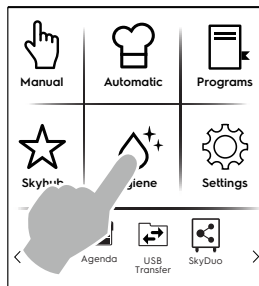

2. Select the required cycle from the list shown:

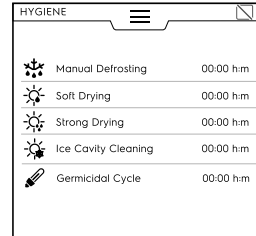

Manual Defrosting

The appliance has an automatic defrost but it is possible to select a manual defrost based on need.

Soft Drying

This function allows to perform a light cavity drying from condensation.

Strong Drying

This function allows to perform an intense cavity drying from condensation.

Ice Cavity Cleaning

This function allows to remove in a short time huge deposits of ice from the cavity that formed when using the appliance with very low temperature.

Germicidal Cycle

Available as option or only on specific models combined with special accessory.

It allows to sanitise the surfaces and the air inside the appliance compartment. It can also be used for kitchen utensils such as: knives, carving forks, etc.

If the internal temperature is less than +15°C the cycle will not start.

Do not use this function if there is food in the compartment.

It is advisable to do a germicidal cycle at the start of the day before using the appliance, and another at the end of the day, after cleaning the compartment.



NOTE!

To maintain a maximum efficiency of the Germicidal Cycle, it is advisable to replace the UV-C lamp every 10 years.

The appliance has a safety device that switches off the lamps when the door is opened.

This safety feature is provided because exposure to UV-C radiation emitted by the lamps is harmful and can damage eyes.

3. Open the door;

4. Open the drain plug;

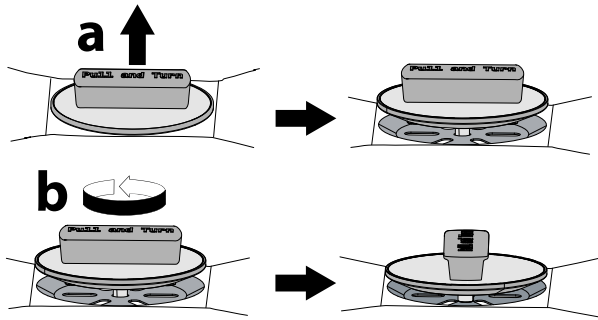

If a Manual Defrosting or a Soft/Strong drying is selected, keep the door opened with door stopper until the cycle ends.

5. Touch the button to start the cycle; At the start of the cycle, if the door is closed, a popup window opens showing the message to open the door.

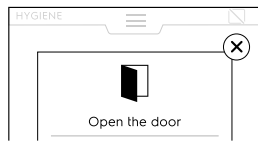

7. When the cycle is finished a pop window appears showing the following message:

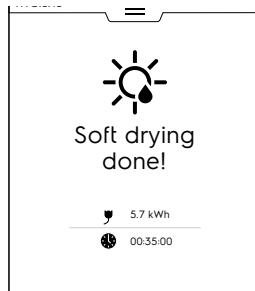

Electric consumption in kWh

Time consumption in hours : minutes : seconds

8. Close the drain plug immediately after the cleaning.

F.13 Settings mode

“Settings” mode allows to change some usage parameters of the appliance.

1. Open the upper drawer and select Settings;



2. The display shows the main menu with ALL SETTINGS;

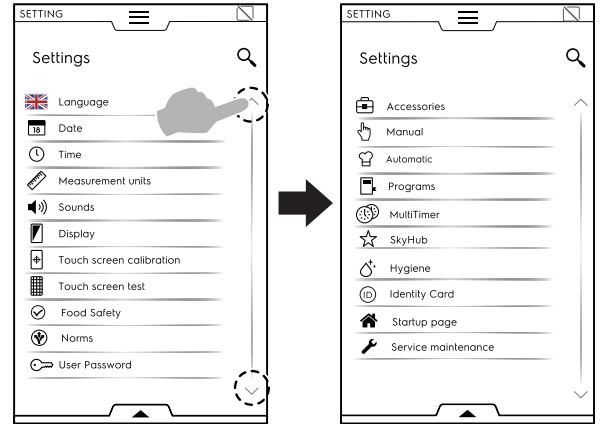

Default setting

If it is required to restore the factory setting, proceed as follows:

1. Open the lower drawer and select Default settings;

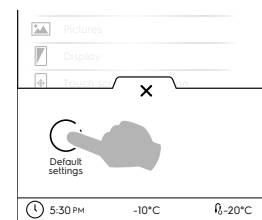

2. Confirm restoring to close the pop-up window.

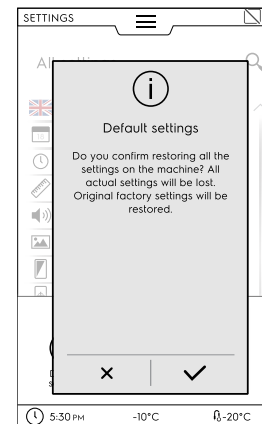

SETTINGS LIST

Language

This parameter allows to customize all menus in the selected language.

- Touch the flag icon;
- The display shows all settings in the required language.

Date

This setting allows to set the current date.

- Set the date format (D/M/Y, D/M/Y, Y/M/D)
- Enter the date: touch “<” / “>” to select the month and year and touch the corresponding number on the calendar to select the day.

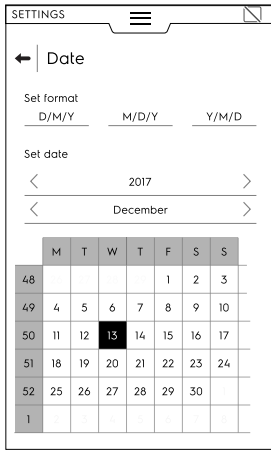

🕒 Time

- This setting allows to set the current time.
- Set the time format (24H or 12H AM/PM)
 - Enter the time: touch the corresponding number on the keypad and, when necessary set also AM or PM.

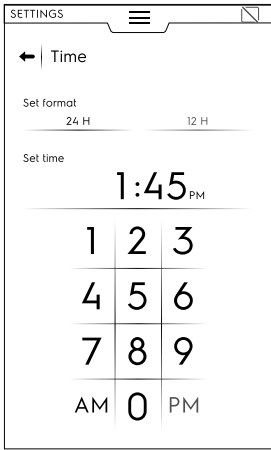

📏 Measurement units

It allows to set the Measurement units of the temperature °C or °F.

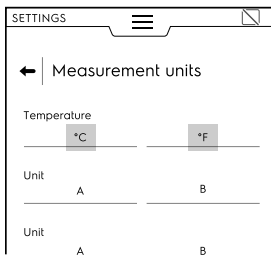

🔊 Sounds

- This setting allows to:
- Enable / disable touch panel tapping sound (☑️ / ☐)
 - Set the volume level
 - Enable / disable the End-cycle sound (☑️ / ☐)
 - Set the End-cycle sounds

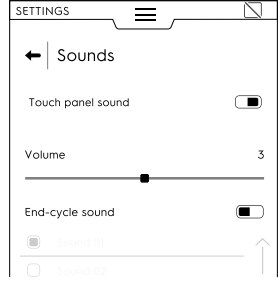

📺 Display

This setting allows to adjust the brightness of display.

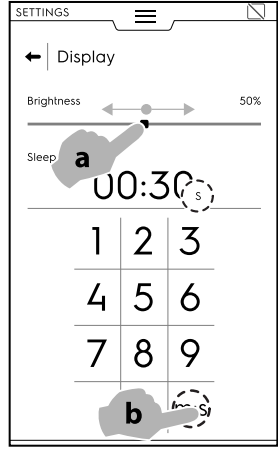

📏 Touch screen calibration

This setting allows to set the calibration of the screen.

1. Touch the screen as close as possible to the centre of the red cross;
2. Repeat until the cross turns green;
3. Touch and hold to exit;

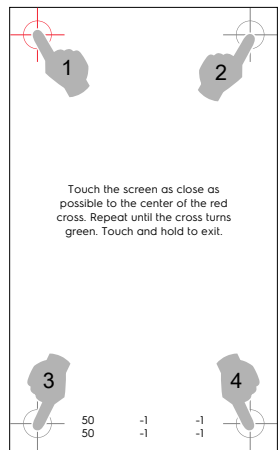

📱 Touch screen test

- Touch the points required to test the screen.
- Hold down to exit.

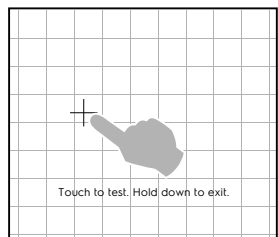

✅ Food safety (HACCP)



Norms

This setting allows to activate/deactivate (/) Norms section:

- Custom
- UK
- NF
- NSF

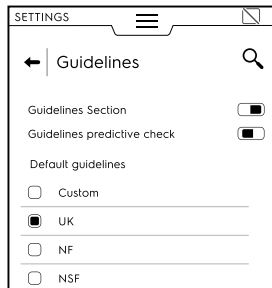

Enabling the function “Guidelines predictive check” it is possible to have a prediction of the normative check results already during the first part of the cycle, thanks to the time end estimation algorithm.

UK-NF-NSF parameters are not modifiable. It is possible to change only Custom parameters.

Select Custom and open the drop-down list to change the following parameters:

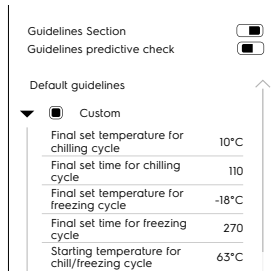

- Final set temperature for chilling cycle
- Final set time for chilling cycle
- Final set temperature for freezing cycle
- Final set time for freezing cycle
- Starting temperature for chill/freezing cycle



User Password

- This setting allows to set a password to access into specific environments, features and options to prevent setting changes.

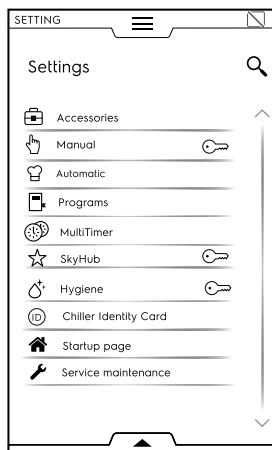

If the password is forgotten, contact the Service.



Accessories

It allows to enable/disable (/) the following accessories:

- Skyduo (Match)
- USB food probe
- Multiple probe selection



Manual

It allows to enable/disable (/) Manual mode and modify its options:



NOTE!

If a mode is disabled, it is not visible in the upper drawer.

General

- Show real and set values (The activation allows to display the cycle with more detailed information).
- Precooling (The activation allows the appliance to perform the precooling phase).
- Advanced precooling (The activation allows the appliance to visualize and perform a Precooling phase from the Multiphase drawer).
- Delayed start precooling (The activation allows the appliance to perform the preparation phase before the cycle start).
- Multiphase cooling (The activation allows the appliance to perform Multiphase cooling cycle).

Timer / Temperature dialogs

- Short cycle (mm:ss)
The activation enables the short cycle feature showing up.
- Minimum cavity-probe temperature difference.

Utilities

- Cooling info in drawer
- Delayed start
It allows to enable/disable the “Delayed Start” option.
If it is enabled, the Delayed start icon is visible on bottom drawer.

Holding

- Default positive holding temperature 3°C (Touch the value to adjust the default temperature).
- Default negative holding temperature —22°C (Touch the value to adjust the default temperature).

Default Lite-Hot temperature 40°C

Touch the value to adjust the default temperature.

Default soft chill temperature 0°C

Touch the value to adjust the default temperature.

Default Hard chill temperature -20°C

Touch the value to adjust the default temperature.



Automatic

This setting allows to enable/disable (/) Automatic mode and modify its options:



NOTE!

If a mode is disabled, it is not visible in the upper drawer.

Presets management:

- **Food type**
This setting allows food families showing up on the display.
- **Cycles+**
This setting allows single special cycle showing up on the display.

Programs

This setting allows to enable / disable (/) the Programs mode and the related functions.

The functions are divided into General, Local Programs and Cloud Programs:

General

- Enable management from Cloud. It enable to download/ manage programs from Cloud.
- Enable messages in Programs. It allows messages displaying during a running.
- Enable skip precooling. It allows to skip the precooling phase.
- Categories visualisation. This activation allows food categories to show up on the display.
- Most used visualisation. It allows most used programs to show up on the display.

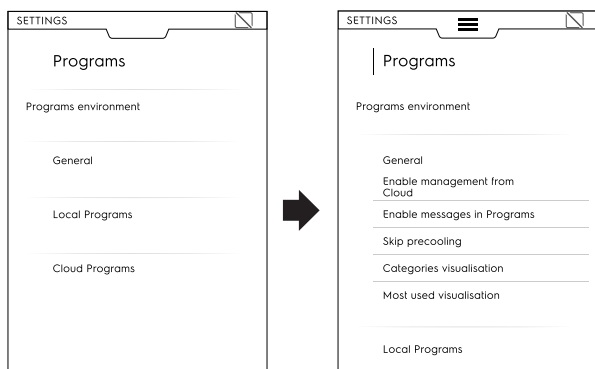

Local Programs

- Programs delete. It enable the “delete programs” function.
- Programs modify. It allows to “modify programs”.
- Programs save. It allows to “save program”.
- Programs overwrite. When saving, it allows to overwrite programs with the same name.

Cloud programs

- Programs delete. It allows the “delete programs” function.
- Programs modify. It allows to “modify cloud programs”.
- Programs save. It allows to “save cloud programs”.

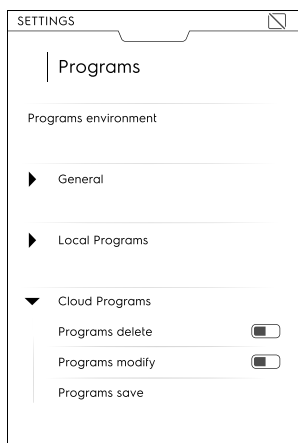

Multitimer

This setting allows to enable/disable (/) the Multitimer feature and its options:

Multitimer options:

- Advanced MT
This activation allows Multitimer advanced feature to show up on the display.
- MT programs

This activation allows Multitimer programs to show up on the display.

- MT temperature recovery

MT presets:

- Presets save
This activation allows “save preset” function to be shown on the display.
- Presets modify
This activation allows “modify preset” function to be shown on the display.
- Presets delete
This activation allows “delete preset” function to be shown on the display.

★ Homepage Mode (SkyHub/SoloMio)

This setting allows to enable/disable (/) the Homepage Mode (SkyHub/SoloMio) and the “Manage Skyhub” option.



NOTE!

If a mode is disabled, it is not visible in the upper drawer.



Hygiene

It allows to enable/disable (/) Hygiene mode and modify its options:

Soft drying cycle time duration

Strong drying cycle time duration

It allows to change the

Default cycle

- Manual defrosting
- Soft drying
- Strong drying



NOTE!

If a mode is disabled, it is not visible in the upper drawer.



Identity Card

It shows the latest uploaded software version.



Startup page

When the chiller is switched on the default startup page is Manual mode.

- This setting allows to set a different environment for the starting page. Select the required environment.

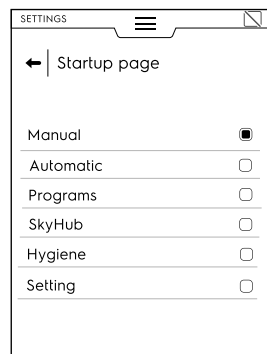

Service

This settings is only allowed to an authorized technician.

F.14 Help mode

This function provides QR codes in order to display the user manual on your device (smartphone, tablet or laptop).

1. Make sure to have the application for QR code reading on your device and an internet connection available;
2. Select Help mode;

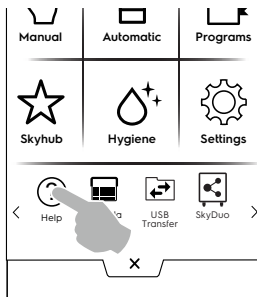

3. The display shows the QR code;



4. Scan the QR code;
5. Consult the documents needed;

F.15 Agenda mode (My Planner/Calendar)

This function allows to plan appliance activities, chilling — freezing — hot cycles, hygiene programs or to set reminders, according to your schedule.

1. Select the agenda function in the upper drawer;

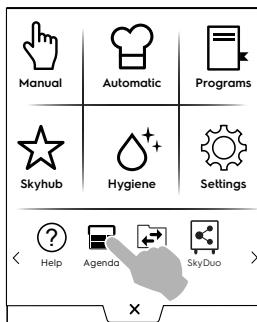

2. Select a date and time:

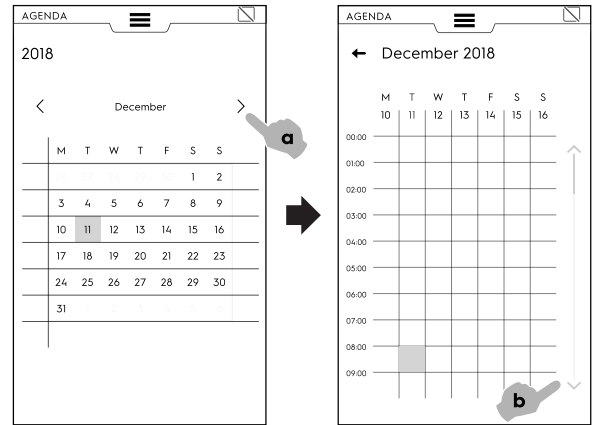

- a. Touch to scroll the months;
- b. Touch to scroll down the time;

3. Touch the required time:

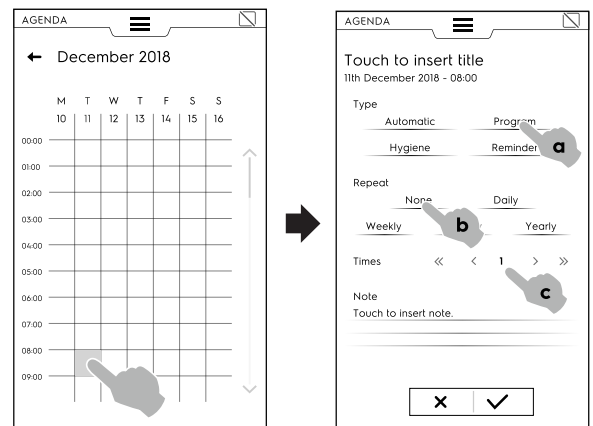

- a. Select the event type;
- b. Select the frequency;
- c. Select the event number.

EXAMPLES of setting:

“Programs“ setting

- Select date and time;
- Select the event type (for example Programs);
The display shows the list of the stored programs. Select the required program among the available ones.

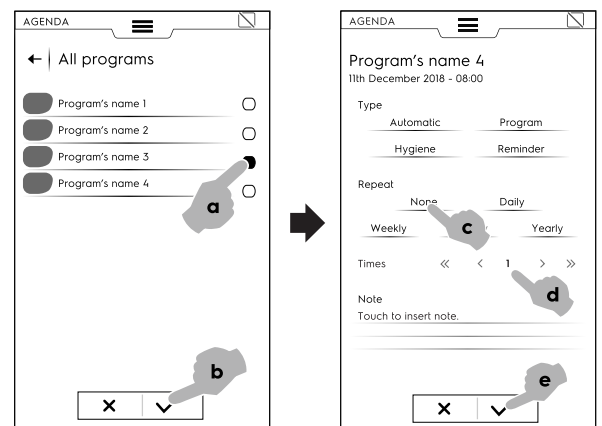

- Select the frequency and the event number and confirm;
The display shows in the calendar the selected program at the required time.

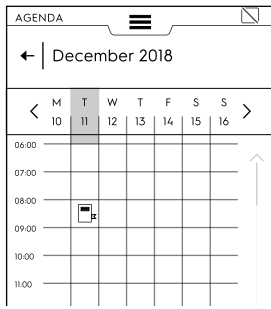

“Automatic” setting

- Select the date and the time;
- Select the event type (for example Automatic);
The display shows the list of all food families stored;
- Select the required food family from the list, the preset and confirm;

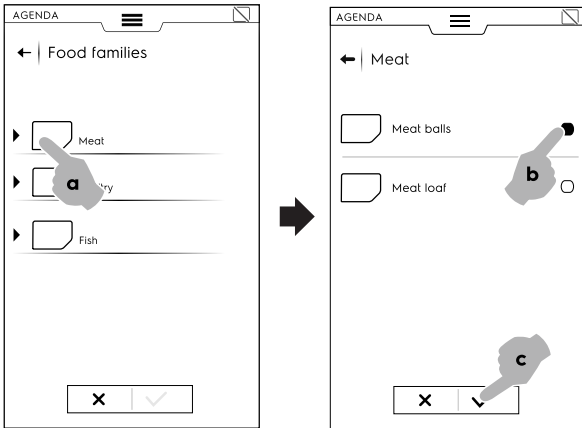

- Select the frequency and the event number and confirm;
The display shows in the calendar the selected event at the required time.

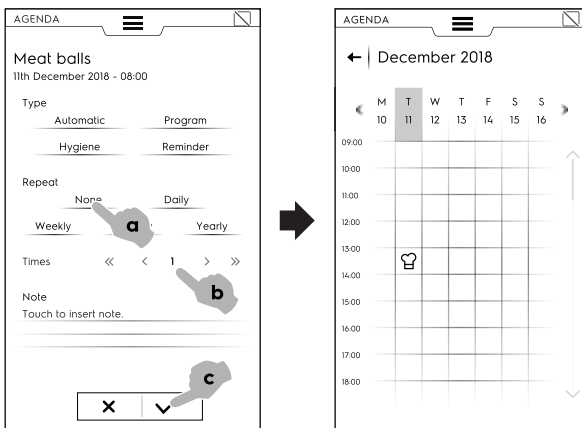

“Hygiene” setting

- Select the date and the time;
- Select the event type (for example Hygiene);
The display shows the list of all hygiene cycles.

- Select the required cycle from the list and confirm;

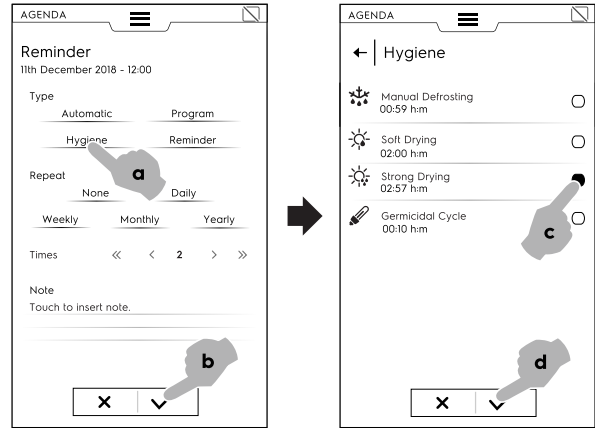

- Select the frequency and the event number and confirm;
The display shows in the calendar the selected event at the required time.

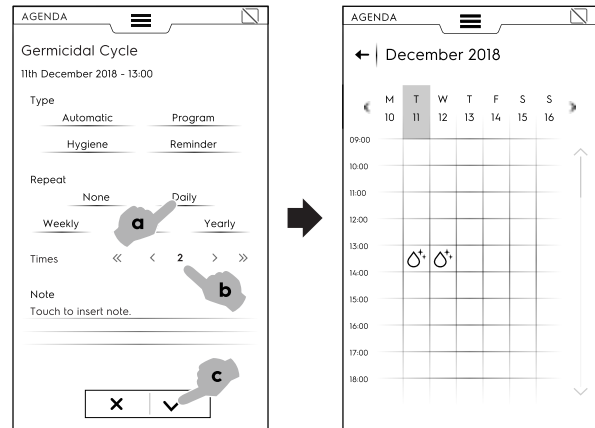

“Reminder” setting

- Select date and time;
- Select the event type (for example Reminder);
- Type the reminder title on the keypad and confirm;
- Type the reminder text in note field and confirm;

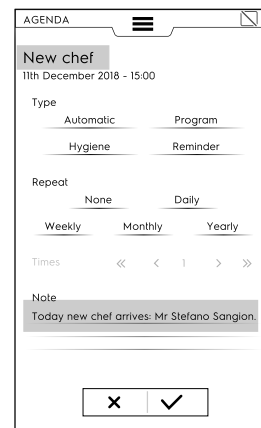

- Select the frequency and the reminder number and confirm; The display shows in the calendar the selected event at the required time;

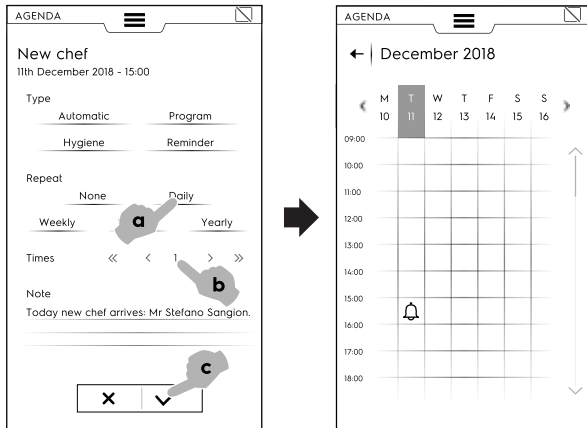

If there are other planned events on the calendar the display shows them up:

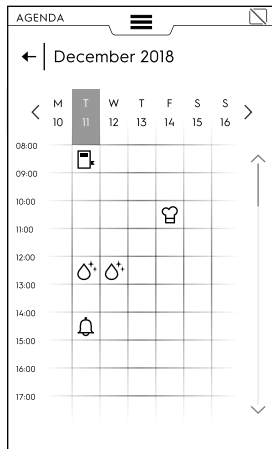

2. If this is a repeated event, a message asks for setting the type of deletion, single event or all repetitions. Choose the deletion type;

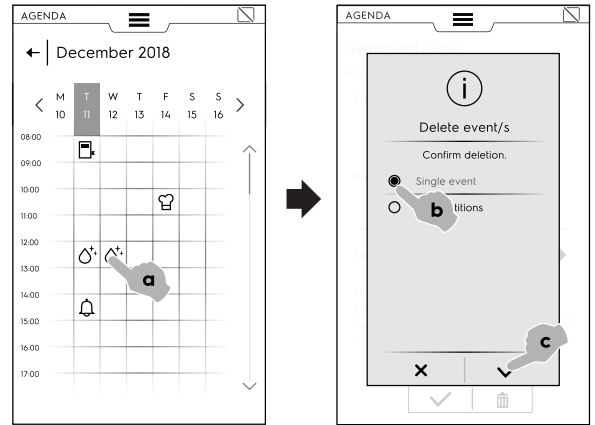

The calendar shows the event deletion:

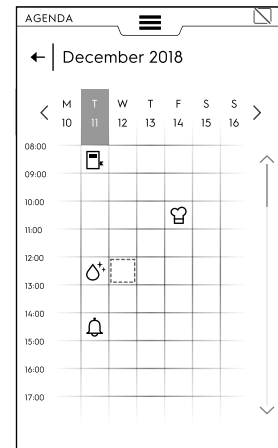

If there is in agenda an event planned while the blast chiller is still working, the appliance advises that the event cannot start. It is necessary to plan a new event.

Cancellation of an event

1. Select an event and touch the icon

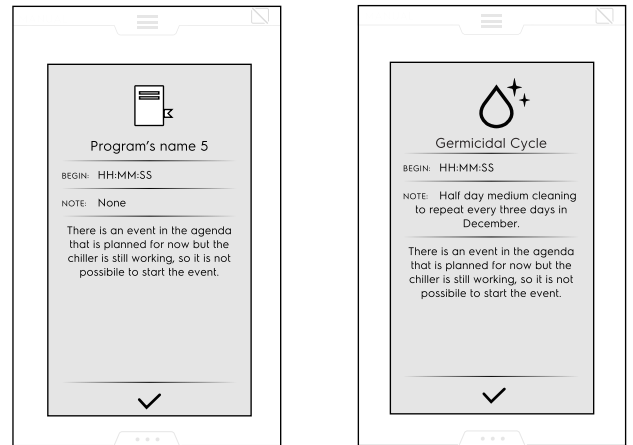
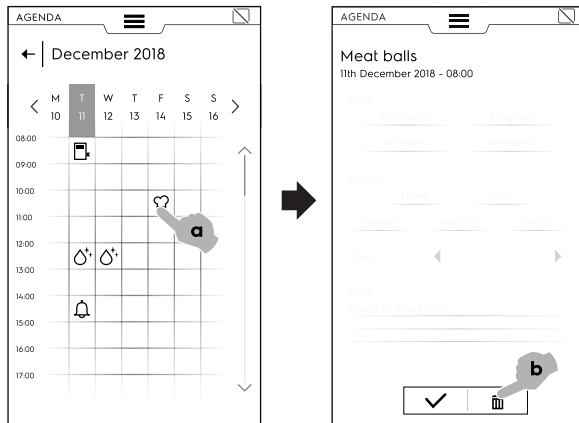

F.16 Usb mode

“Usb” mode allows to upload/download, from or into the appliance, programs or other data by means of the USB pendrive.

1. Select Usb from the upper drawer.

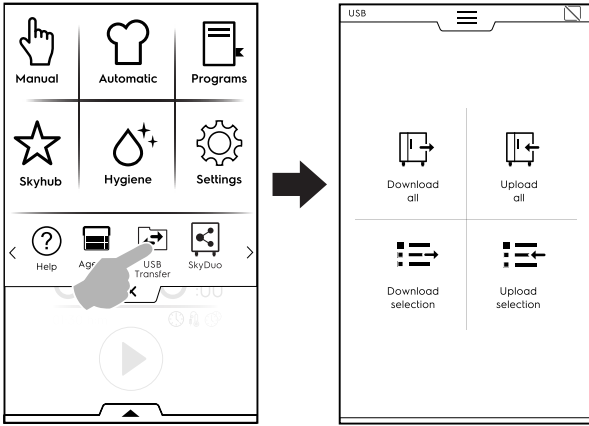

2. Choose the required function.

Download all

- Select Download all.
- Select the required option and confirm.

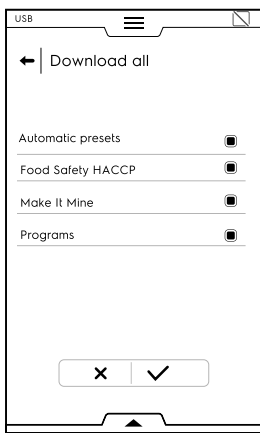

- Replace a backup in the list or select Add new name. Touch ✓ to confirm it.
- If selecting an existing backup the appliance overwrites the current one.
If selecting Add new name, type it on the appearing keypad. If a file with the new name already exists, a popup window informs that the name has to be changed.

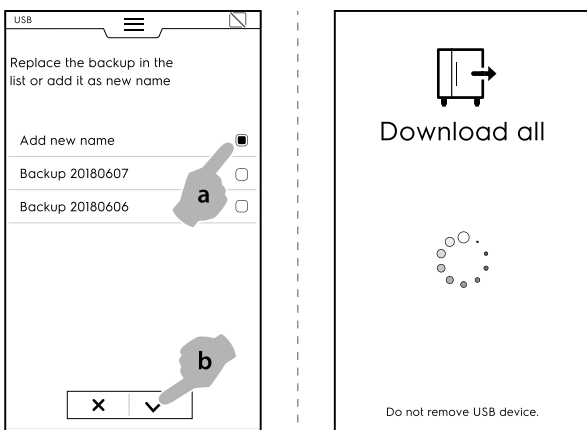

The download starts.

NOTE!
Do not remove the USB pendrive during the download.

Upload all

- Select Upload all.

- Select one of the existing backups. Then select the option associated with the selected backup.

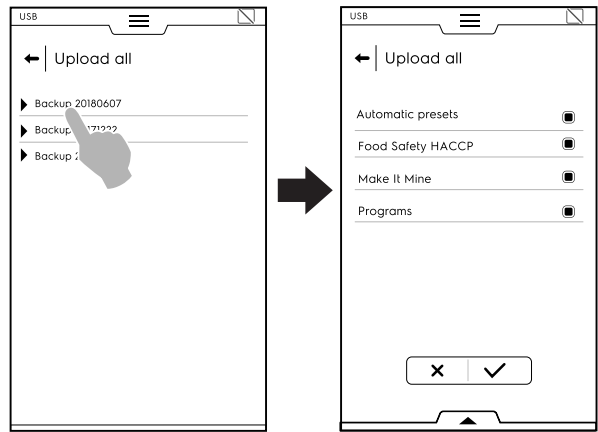

- Confirm the selection. Upload starts.

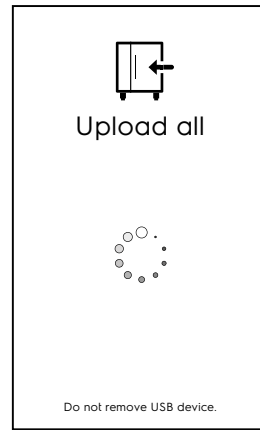

Download selection

- Select Download selection.
- Expand the required option. All files associated are selected.

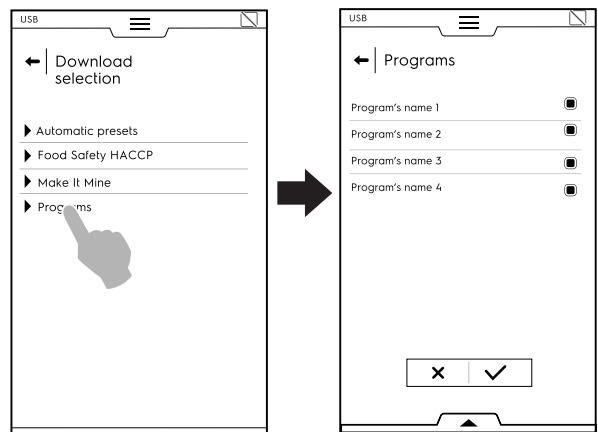

- Deselect the required files and confirm.
It is possible to select all files or to check the selected ones through the **bottom drawer**:

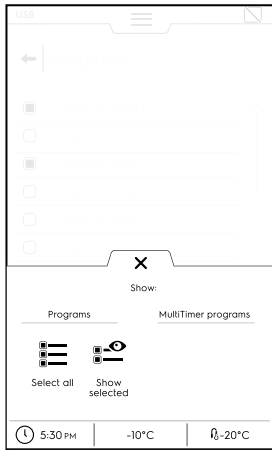

☰ Select all

🔍 Show selected

- The just created backup can replace an existing one or can be stored with a new name. If a file with the new name already exists, a popup window informs that the name has to be changed. The download starts.

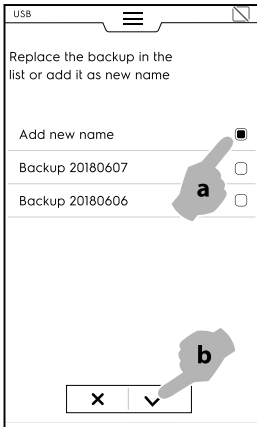

- All files associated are selected. Deselect the not needed files and confirm. Regarding the selected files, the appliance asks to choose:
 - adding them to the actual ones;
 - clearing the existing ones and upload the selected items;

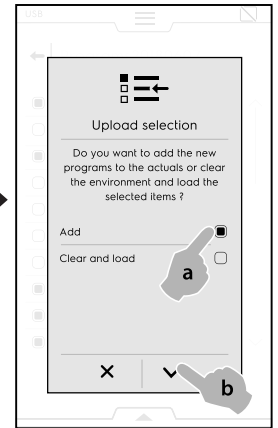
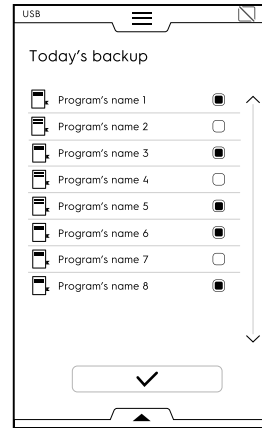

- If selecting "adding them to the actual ones" and a file name is already existing, a popup window asks how to proceed:
 - Rename
 - Replace
 - Skip

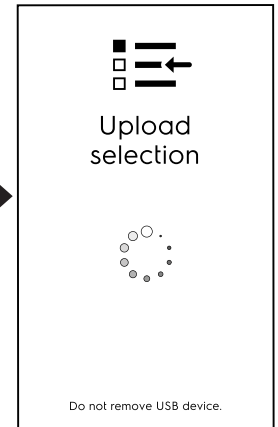
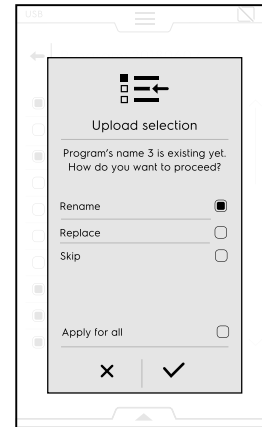

Confirm the selection; the upload starts.

Upload selection

- Select Upload selection;
- Expand the required option;
- Select and expand the required backup from the list.

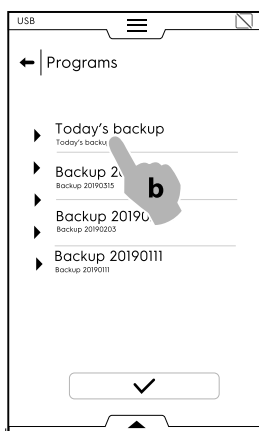
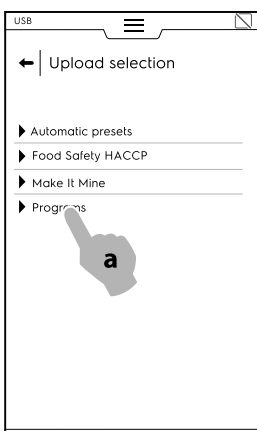

F.17 Graphs mode

"Graphs" mode allows to show the graphical behaviour of chilling cycles, both Manual, Programs and Automatic ones. It is only available when the appliance is not executing any kind of cycle.

Automatic recording of every cycle is done within the User Interface. Recordings lasting less than one minute are automatically removed from the memory at the end of the chilling cycle (manual or automatic). Each record is kept in the machine's memory for 180 days after which it is automatically removed.

1.

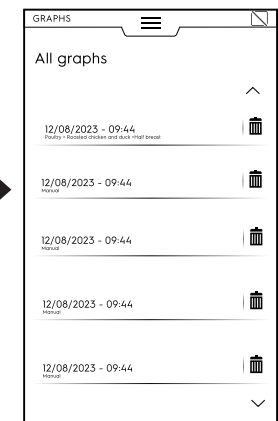
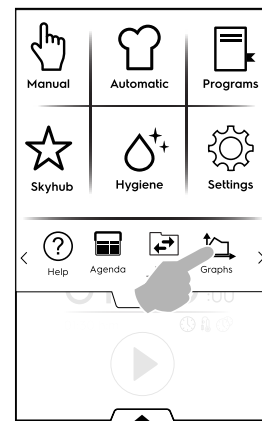

2.

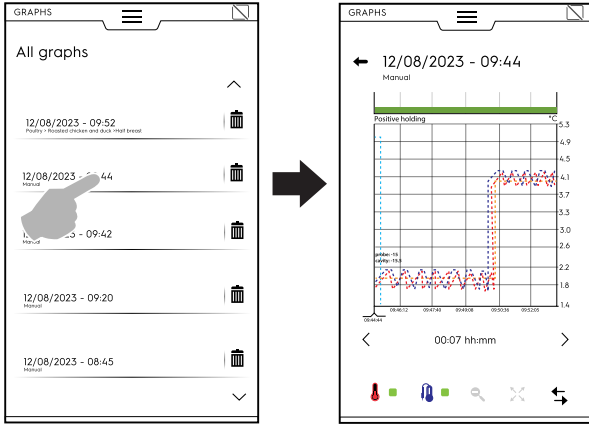

F.18 SKYDUO/MATCH MODE (depending on your model - optional)

This option can be activated on demand. It works with a Wi-Fi or Ethernet connection, installed by an authorized technician and allows you to connect the oven and a blast chiller.



IMPORTANT

Make sure you have the SkyDuo/Match option activated in both appliances. Only an authorized technician can install and activate the SkyDuo/Match option.

When the SkyDuo/Match icons are green in both appliances (see figure below), the connection works properly.

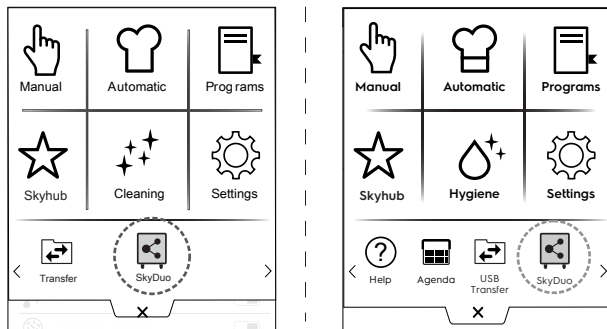

To disable (or enable) SkyDuo/Match touch the green icon and then touch the icon / on the display to change SkyDuo/Match status.

The synchronization process can start from any of the two appliances (caller and recipient).

The search for a similar program between the two appliances considers any program that contains at least **one word** present in the caller program's name. The recipient proposes all the cycles that meet these criteria.

It is possible to combine the SkyDuo/Match both in Automatic and in Programs mode.

AUTOMATIC MODE

1. Select for example a cooking cycle in the Automatic mode of the OVEN;

A. Select the food type (for example Meat)

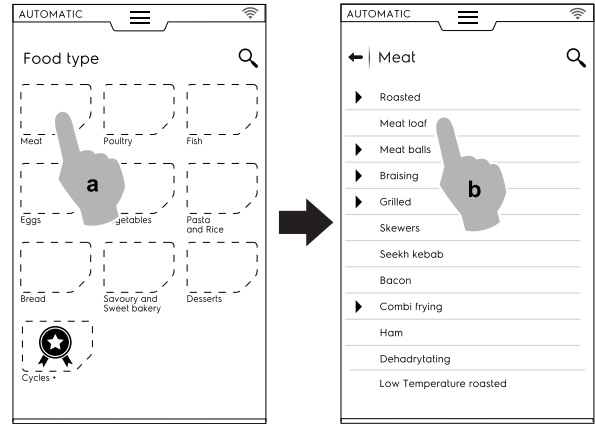

B. Select the required food cooking (for example Meat loaf)

C. Select cooking parameters, if present;

In this case select the Browning level and the probe temperature.

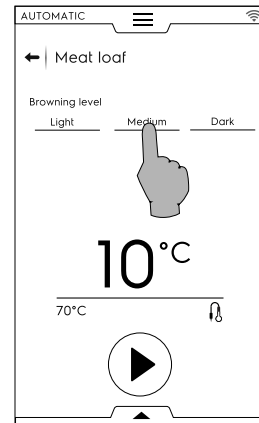

D. Start the cycle;

2. The OVEN, connected with the blast chiller, has found a paired cycle in the blast chiller;

Select the required cycle (for example X-chill) and confirm;

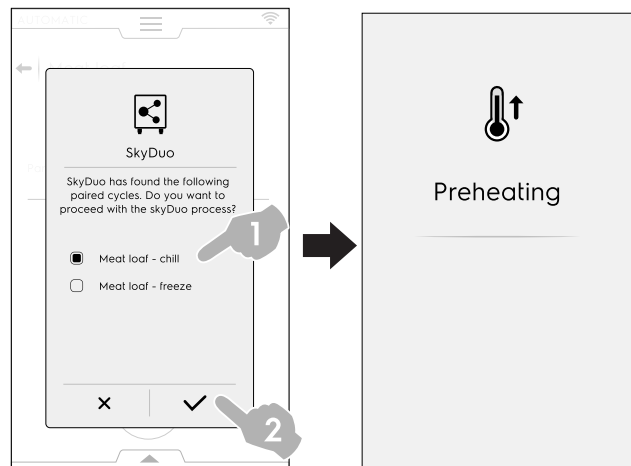

3. The BLAST CHILLER asks how to proceed; it is possible to:

- Abort the process: touch the **X** to stop the process.

- Postpone the process of synchronization: touch the icon  to postpone the connection with the oven.

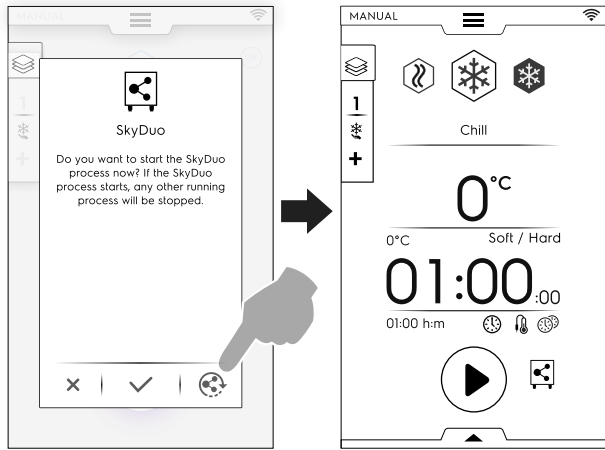

- Confirm the synchronization: touch the icon  to start immediately the SkyDuo process in the blast chiller. Any other running process will be stopped.

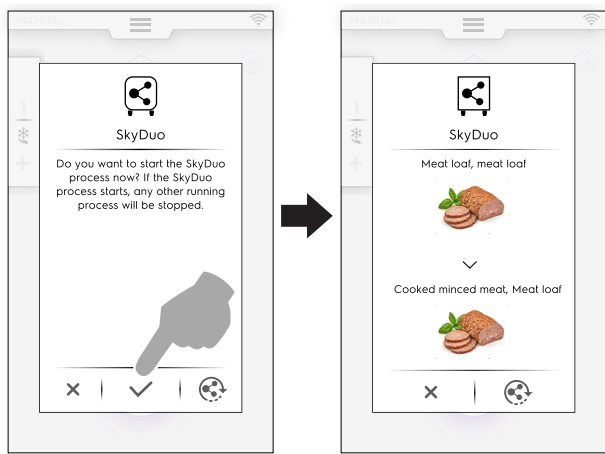

NOTE!
If an automatic cycle hasn't a graphic associated in one of the appliances, it will be replaced by the icon .

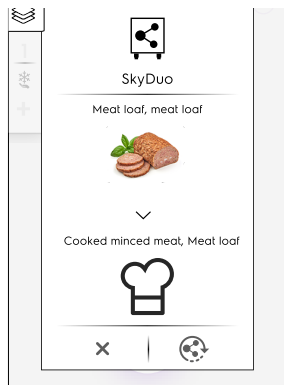

- Some minutes before the OVEN cycle ending, in the blast chiller precooling cycle starts to prepare the cavity for the food just cooked.
If you had postponed the SkyDuo process, some minutes before the end of the oven cooking cycle, a new pop-up with the request of synchronization will appear.



You can still confirm or postpone the process again.

PROGRAMS MODE

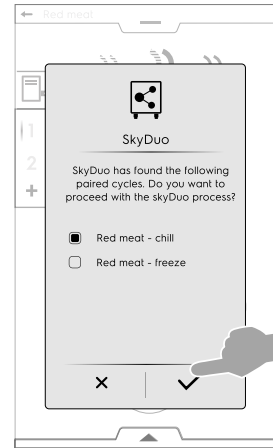
- Select a cooking cycle in the Programs mode of the OVEN (for example Red Meat);
- Start the cycle;
- The oven, connected with the blast chiller, proposes all the cycles that contain at least **one word** present in the blast chiller program's names;
Choose the required cycle and confirm the selection;



- In the BLAST CHILLER; it is possible to:

- Stop the process by touching the .
- Confirm the synchronization.
- Postpone the process of synchronization by touching the icon .

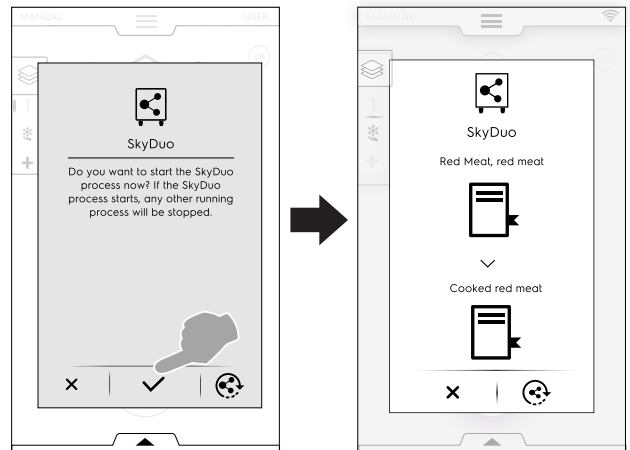

NOTE!
If a programme hasn't a graphic associated in one of the appliances, it will be replaced by the icon .

- Some minutes before the OVEN cycle ending, in the BLAST CHILLER precooling cycle starts to prepare its cavity for the food just cooked.
If you had postponed the SkyDuo process, some minutes before the end of the oven cooking cycle, a new pop-up with the request of synchronization will appear.

G MACHINE CLEANING AND MAINTENANCE



WARNING

Refer to “Warning and Safety Information”.

G.1 Ordinary maintenance

G.1.1 Care information

Care operations have to be carried out by the owner and/or user of the appliance.



IMPORTANT

Problems resulting from poor or lack of care as hereinafter described will not be covered by the warranty.

G.1.2 Cleaning introduction

For detailed information regarding appliance cleaning refer to paragraph A.12 *Cleaning the cabinet and accessories*.

G.1.3 Appliance Cleaning

It is advisable to clean the compartment weekly or whenever the appliance remains inactive for more than 12 hours; increase the frequency according to appliance use.

The appliance is provided with a Hygiene cycle. See paragraph F.12 *Hygiene mode* in this guide.

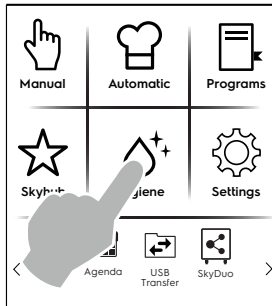

G.1.4 Cleaning the probe



IMPORTANT

Pay particular attention when handling the probe; remember that it is a sharp object, therefore handle it very carefully, even during cleaning.

Clean the probe regularly to ensure its efficiency. The probe must be cleaned by hand, using lukewarm water and neutral soap or products that are over 90% biodegradable, then rinsed with clean water and a sanitising solution.



CAUTION

Do not use boiling water to clean the probe.

G.1.5 Cleaning tray supports and internal structure

The tray supports and internal structure are removable and washable in dishwasher.

To remove them, proceed as shown in the figures:

1.

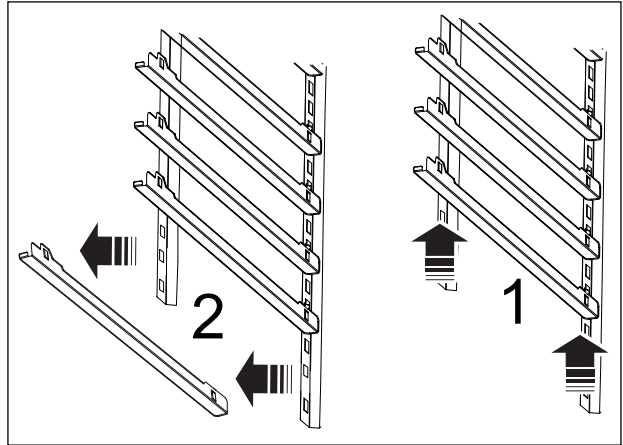

2.

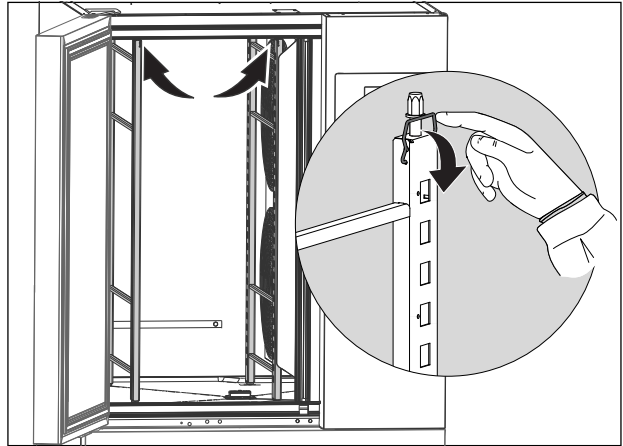

3.

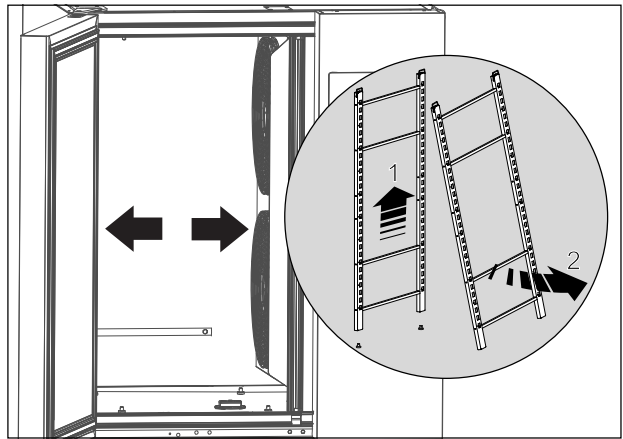

G.1.6 Cleaning drain plug

To clean the drain plug, remove it as shown in the figure below:

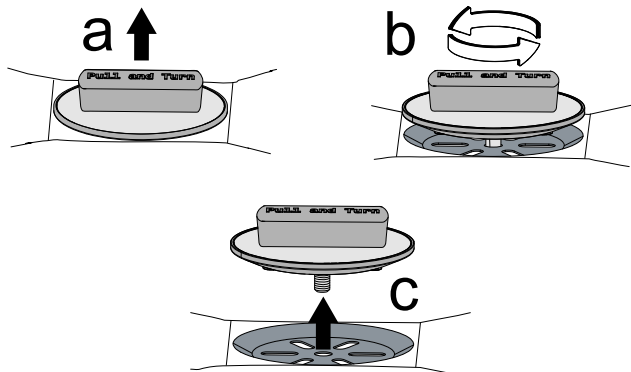

Clean it with lukewarm water and neutral soap, then rinse and dry thoroughly.

G.1.7 Cleaning other surfaces

Clean metal and plastic parts only with non-aggressive detergents. Stop immediately using those products if detecting any visual or tactile characteristic change on surfaces and thoroughly rinse with water (examples: plastic discolouring / melting / other, or metal showing rust/stains/scratches). Carefully dry after rinsing.

G.1.8 Periods of non-use

If the appliance is not going to be used for some time, take the following precautions:

- disconnect the power supply or remove the plug from the power socket, if present;



- carefully clean the internal parts of the appliance;
- remove all food from the compartment and clean the inside and accessories;
- clean the cabinet, going over all the stainless steel surfaces vigorously with a rag moistened with paraffin oil to create a protective film;
- leave the door or drawers, if present, open so that air can circulate inside, preventing the formation of unpleasant odours;
- periodically air the premises.

H TROUBLESHOOTING

H.1 Introduction

Certain faults may occur during normal use of the appliance. In some cases, faults can be eliminated easily and quickly by following the indication below.

The display, if present, always shows a warning message or alarm describing the occurring fault.

	Warnings icon
	Alarms signalling icon

2. Switch off the safety circuit breaker ahead of the appliance;
3. Remember to specify:
 - the type of fault
 - the appliance PNC (product number code)
 - the Ser. No. (appliance serial number).



IMPORTANT

The appliance PNC and serial number are essential for identifying the type of appliance and date of manufacture.

The dataplate giving the product and technical data is located inside the appliance. The plate giving the appliance PNC code and serial number is located in the unit compartment.

If the fault persists, contact the Customer Care Service:

1. Disconnect the appliance from the main power supply;

H.2 Anomaly table

CODE	TYPE OF ANOMALY	DESCRIPTION	POSSIBLE CAUSES	ACTIONS
swcTTm	INFO	Give information about switching operations from probe to time	Food probe not inserted in food	In case of cycles based on food temperature, insert the probe into the food otherwise the cycle will automatically switch to time
ECoM	ALARM Stops Machine	Communication error between boards	<ul style="list-style-type: none"> • Internal error -Electronic boards disconnected • Electronic board failure 	<ul style="list-style-type: none"> • Try to switch the unit OFF/ON. • If the problem persists, Call Service.
PFAC	ALARM Stops Machine	Memorized parameters corrupted.	Software corruption	<ul style="list-style-type: none"> • Try to switch the unit OFF/ON. • If the problem persists, Call Service.
PdEF	ALARM Resetting Machine	Memorized default parameters corrupted	Software corruption	<ul style="list-style-type: none"> • The machine loses personalization. Operations can continue. • If the problem shows up again, Call Service.
EFnt	ALARM Stops Machine in 6GN 1/1 models. Reducing Performance on other models	Top evaporator fan failure	<ul style="list-style-type: none"> • Parameter wrong setting • Fan connector wrongly plugged • Fan failure 	<ul style="list-style-type: none"> • CALL SERVICE • 6GN 1/1 models (1 evaporator fan): unit stops and cannot operate until fixing the problem • Other models (more than 1 evaporator fan): unit continues working with reduced performance (Cycle ongoing: the cycle proceeds until end if there is at least one fan working. The cycle stops if no fan is working). • During STANDBY: the alarm cannot be triggered.

CODE	TYPE OF ANOMALY	DESCRIPTION	POSSIBLE CAUSES	ACTIONS
EFnb	ALARM Reducing performance until another fan is working	Bottom evaporator fan failure.	<ul style="list-style-type: none"> Parameter wrong setting Fan connector wrongly plugged Fan failure 	<ul style="list-style-type: none"> CALL SERVICE Unit continues working with reduced performance until at least another fan is working (Cycle ongoing: the cycle proceeds until end if there is at least one fan working. The cycle stops if no fan is working). During STANDBY: the alarm cannot be triggered.
EFnc	ALARM Reducing performance until another fan is working	Center evaporator fan failure	<ul style="list-style-type: none"> Fan connector wrongly plugged Fan failure 	<ul style="list-style-type: none"> CALL SERVICE Unit continues working with reduced performance until at least another fan is working (Cycle ongoing: the cycle proceeds until end if there is at least one fan working. The cycle stops if no fan is working). During STANDBY: the alarm cannot be triggered.
E1	WARNING	Cavity low temperature (only during holding cycles: positive or negative)	<ul style="list-style-type: none"> Delay time set too short Delta temperature set too narrow Evaporator icing 	<ul style="list-style-type: none"> The cavity temperature is below the holding cycle temperature set point for more than the set time (default time = 1hour). The cycle will continue until stopping. Open the door for increasing the temperature inside the cavity: check it after a couple of minutes. Launch a manual defrost cycle. Call service if the problem reoccurs.
E3	ALARM Stops machine	Cavity probe failure	<ul style="list-style-type: none"> Connector unplugged Probe and/or Probe wire damaged 	<ul style="list-style-type: none"> The chiller will continue working until the end of the running cycle. Not possible to start other cycle till to Technical Service replace the probe. CALL SERVICE
E4	WARNING	Evaporator probe failure	<ul style="list-style-type: none"> Connector unplugged Probe and/or probe wire damaged 	<ul style="list-style-type: none"> The chiller will continue working: the defrost setting will be based on time. Call Service and inform about the message displayed.
E14	WARNING	Out Evaporator probe failure	<ul style="list-style-type: none"> Connector unplugged Probe and/or probe wire damaged 	<ul style="list-style-type: none"> The chiller will continue working. Call service and inform about the message displayed.
E15	ALARM Stops Machine	Condenser probe failure	<ul style="list-style-type: none"> Connector unplugged Probe and/or probe wire damaged 	<ul style="list-style-type: none"> CALL SERVICE This failure blocks also running cycle. Quickly remove the load from the cavity for preventing waste of food.
E16	ALARM Stops Machine	Condenser high temperature	<ul style="list-style-type: none"> Position of condenser probe is not correct Fan condenser not working The condenser is dirt or the grid has tapped holes The unit does not discharge warm air due to position too near to wall 	<p>This failure blocks also running cycle.</p> <ul style="list-style-type: none"> Quickly remove the load from the cavity for preventing waste of food. Using a vacuum cleaner, remove any dust/dirt from the condenser inlet-air grid. If the alarm persists Call Service.

CODE	TYPE OF ANOMALY	DESCRIPTION	POSSIBLE CAUSES	ACTIONS
Eprb1	ALARM Stops food probe cycles	Core probe failure sensor n°1	<ul style="list-style-type: none"> • Food probe misuse (for example, wire pulled or squeezed) • Connector failure • Probe failure • PCB failure 	<ul style="list-style-type: none"> • Current running cycle: <ul style="list-style-type: none"> a) the cycle continues in probe mode until at least one out of the 6 food probe points is working. b) the cycle switches to time mode if none out of the 6 food probe points is working. • During STANDBY: <ul style="list-style-type: none"> a) the cycle can be started until at least one point is working. b) the cycle can be started in time mode in case all points are failed. • To restore full functionality, call Service.
Eprb2	ALARM Stops food probe cycles only if the entire sensor is faulty	Core probe failure sensor n°2	<ul style="list-style-type: none"> • Food probe misuse (for example, wire pulled or squeezed) • Connector failure • Probe failure • PCB failure 	<ul style="list-style-type: none"> • Current running cycle: <ul style="list-style-type: none"> a) the cycle continues in probe mode until at least one out of the 6 food probe points is working. b) the cycle switches to time mode if none out of the 6 food probe points is working. • During STANDBY: <ul style="list-style-type: none"> a) the cycle can be started until at least one point is working. b) the cycle can be started in time mode in case all points are failed. • To restore full functionality, call Service.
Eprb3	ALARM Stops food probe cycles only if the entire sensor is faulty	Core probe failure sensor n°3	<ul style="list-style-type: none"> • Food probe misuse (for example, wire pulled or squeezed) • Connector failure • Probe failure • PCB failure 	<ul style="list-style-type: none"> • Current running cycle: <ul style="list-style-type: none"> a) the cycle continues in probe mode until at least one out of the 6 food probe points is working. b) the cycle switches to time mode if none out of the 6 food probe points is working. • During STANDBY: <ul style="list-style-type: none"> a) the cycle can be started until at least one point is working. b) the cycle can be started in time mode in case all points are failed. • To restore full functionality, call Service.
Eprb4	ALARM Stops food probe cycles only if the entire sensor is faulty	Core probe failure sensor n°4	<ul style="list-style-type: none"> • Food probe misuse (for example, wire pulled or squeezed) • Connector failure • Probe failure • PCB failure 	<ul style="list-style-type: none"> • Current running cycle: <ul style="list-style-type: none"> a) the cycle continues in probe mode until at least one out of the 6 food probe points is working. b) the cycle switches to time mode if none out of the 6 food probe points is working. • During STANDBY: <ul style="list-style-type: none"> a) the cycle can be started until at least one point is working. b) the cycle can be started in time mode in case all points are failed. • To restore full functionality, call Service.

CODE	TYPE OF ANOMALY	DESCRIPTION	POSSIBLE CAUSES	ACTIONS
Eprb5	ALARM Stops food probe cycles only if the entire sensor is faulty	Core probe failure sensor n°5	<ul style="list-style-type: none"> Food probe misuse (for example, wire pulled or squeezed) Connector failure Probe failure PCB failure 	<ul style="list-style-type: none"> Current running cycle: <ul style="list-style-type: none"> a) the cycle continues in probe mode until at least one out of the 6 food probe points is working. b) the cycle switches to time mode if none out of the 6 food probe points is working. During STANDBY: <ul style="list-style-type: none"> a) the cycle can be started until at least one point is working. b) the cycle can be started in time mode in case all points are failed. To restore full functionality, call Service.
Eprb6	ALARM Stops food probe cycles only if the entire sensor is faulty	Core probe failure sensor n° 6	<ul style="list-style-type: none"> Food probe misuse (for example, wire pulled or squeezed) Connector failure Probe failure PCB failure 	<ul style="list-style-type: none"> Current running cycle: <ul style="list-style-type: none"> a) the cycle continues in probe mode until at least one out of the 6 food probe points is working. b) the cycle switches to time mode if none out of the 6 food probe points is working. During STANDBY: <ul style="list-style-type: none"> a) the cycle can be started until at least one point is working. b) the cycle can be started in time mode in case all points are failed. To restore full functionality, call Service.
B4	ALARM Stops machine	Supply power missing	<ul style="list-style-type: none"> Power supply missing Supply power system failure Other electrical issues (for example current dispersions) 	<ul style="list-style-type: none"> Current running cycle: the cycle restarts automatically when the power is back. The machine was not in operation for a certain period of time: check initial and end time. Check the plug or general electric control panel. If the alarm reoccurs, Call Service.
Ertc	WARNING	Low battery	<ul style="list-style-type: none"> Battery of User interface is low Electronic board failure 	<p>Problem with battery of internal clock. Functions related to the clock will not operate (example: HACCP event recording will be wrong).</p> <p>CALL SERVICE</p>
ECHt	WARNING	Cavity high temperature	<ul style="list-style-type: none"> Door left open Food too hot in the cavity Issue with parameter ady or with temperature measurement 	<ul style="list-style-type: none"> The cavity temperature has exceeded the set limit, in addition to the signal delay time. Current running cycle: the cycle continues. If the alarm persists even if the cavity temperature is low, call service.
E11	ALARM Stops machine	Compressor failure	<ul style="list-style-type: none"> Fan condenser overload (example: room temperature too high) Electrical issue (example: connector unplugged) Gas leak Compressor damaged 	<ul style="list-style-type: none"> The chiller will be blocked and only fan condenser runs. Check if there is any obstruction at the suction air condenser. <p>CALL SERVICE</p>
B2	ERROR Stops cycle	Door open	<ul style="list-style-type: none"> The door remained open beyond the time limit set whit the active cycle Door closure recognition system is failed 	<ul style="list-style-type: none"> Ensure the chiller door is closed and any physical obstruction is not preventing the door closure. Start new cycle: if either a new cycle will not start or the alarm persists even with the door closed, Call Service.
ACUP	ALARM Stops machine	ACU protocol error	<ul style="list-style-type: none"> ACU board not programmed or programmed with an incompatible Software version Electronic boards disconnected 	<ul style="list-style-type: none"> Communication protocol error detected. If the problem persists, Call Service.

CODE	TYPE OF ANOMALY	DESCRIPTION	POSSIBLE CAUSES	ACTIONS
SdEr	WARNING	SD card not working	Mirco SD memory broken or disconnected	<ul style="list-style-type: none"> SD card not working. Images or Programmes stored on the SD card are lost. The chiller can continue to operate. To restore full functionality Call Service.
		Display is OFF while main switch button is ON.	Connector to display disconnected.	<ul style="list-style-type: none"> Switch the unit Off/On. if the problem persists Call Service.
		Display is stuck on screen saver and does not react.	Issue with the Software.	<ul style="list-style-type: none"> Switch the unit Off/On. If the problem persists Call Service.
		Display shows condensation inside.	Infiltration of water during the cleaning.	<ul style="list-style-type: none"> No actions required in case. It is possible to continue operating with the unit. If any problem operating with the unit, Call Service.
		Switch Button ON_OFF not working.	<ul style="list-style-type: none"> Electric supply issue. Hardware issue. Wiring issue. 	<ul style="list-style-type: none"> Switch the unit Off/On. If the problem persists Call Service.
		External noise/vibrations with cycle ON.	<ul style="list-style-type: none"> Unit unlevelled. Condenser water tray and guide damage. Condenser panel not fix well. 	<ul style="list-style-type: none"> Level the unit with the adjustable feet. Adjust the guide or remove the condenser water tray. Check if the condenser panel is fixed correctly. If the problem persists Call Service.
		Internal noise/vibrations with cycle ON.	<ul style="list-style-type: none"> The tray supports are not allined. The internal rack is not well positioned. Obstruction of cavity fan. Carter/deflector evaporator fan is not fixed well. 	<ul style="list-style-type: none"> Check if the right/left supports are well positioned. Check if the internal rack is well fixed, above and below. Check if the cavity fan working well without any obstructions. Check if the carter evaporator is fixed with screws. If the problem persists Call Service.
		The appliance needs too much time to reach the required temperature.	<ul style="list-style-type: none"> Excessive food load in the cavity. Refrigerant gas leakage. Cavity fan with 3 phases has wrong rotation or is not connected. Thermostatic valve is not set. Compressor valve is damaged. Relay of heating element is stuck. Insulation of pipes and wires on the rear side is missing or damaged. 	<ul style="list-style-type: none"> Reduce the food load in the cavity. If the problem persists Call Service.
		Compressor failure	<ul style="list-style-type: none"> The compressor does not start. The compressor oscillates discontinuously or continuously. Decrease in compressor efficiency. Noisy compressor. 	CALL SERVICE

If the fault persists after carrying out the above checks, contact the Customer Care Service, remembering to specify:

- the type of fault;
- the appliance PNC (production number code);
- the Ser. No. (appliance serial number).



NOTE!

The appliance PNC and serial number are essential for identifying the type of appliance and date of manufacturer.

H.3 Appliance connectivity issues (depending on your SW version)

If the appliance cannot establish a remote connection to Internet, its display shows different icons indicating the connection issue. See below the icons meaning:

Connection errors



Appliance not connected to connectivity module



Not connected to LAN Hub (connected to NIU PROE or IoT module but not to hub)



Not connected to Wifi Hub (connected to connectivity module).



Connected to hub via LAN but not to cloud.



Connected to hub via Wifi but not to cloud.

I FURTHER INFORMATION

I.1 Ergonomic features

I.1.1 Certification

The ergonomic features of your product, that may influence your physical and cognitive interaction with it, have been assessed and certified.

A product with ergonomic features, in fact, shall fulfil specific ergonomic requirements, belonging to three different areas: Polytechnic, Biomedical and Psychosocial (usability and satisfaction).

For each of these areas, specific tests with real users have been performed. The product is therefore compliant with the ergonomic acceptability criteria requested by the standards applied.

I.1.2 General recommendations

The oven or the blast chiller that you use is specifically studied and tested in order to minimise any physical problems associated to the interactions with the product.

The loading and unloading of the trays and the interaction with the product may bring to incongruous postures and handling of heavy weights – characteristics of your daily activity that we tried to relieve.

In any case we would like to suggest a few operating procedures to adopt:

- Handle the tray in a balanced way, trying not to arch your back during the loading/unloading.
- If possible, flex your legs and don't bend forward your back during the placement of the trays in the lower shelves and during the achievement of any lower tools or items.
- If possible, try to place the trays in the cavities considering their weights, as suggested by the pictures below.
- If possible, push the tray holder trolley and pull it in order to reduce the distances.
- Keep the viewing distance in order to understand properly the information displayed in the display or to view the object in the cavity, reducing as much as possible the time spent with the eyes up (neck extensions).

Suggested movement of trays according to their weights

Try to place the trays into the cavities considering their weights as suggested by the pictures below.

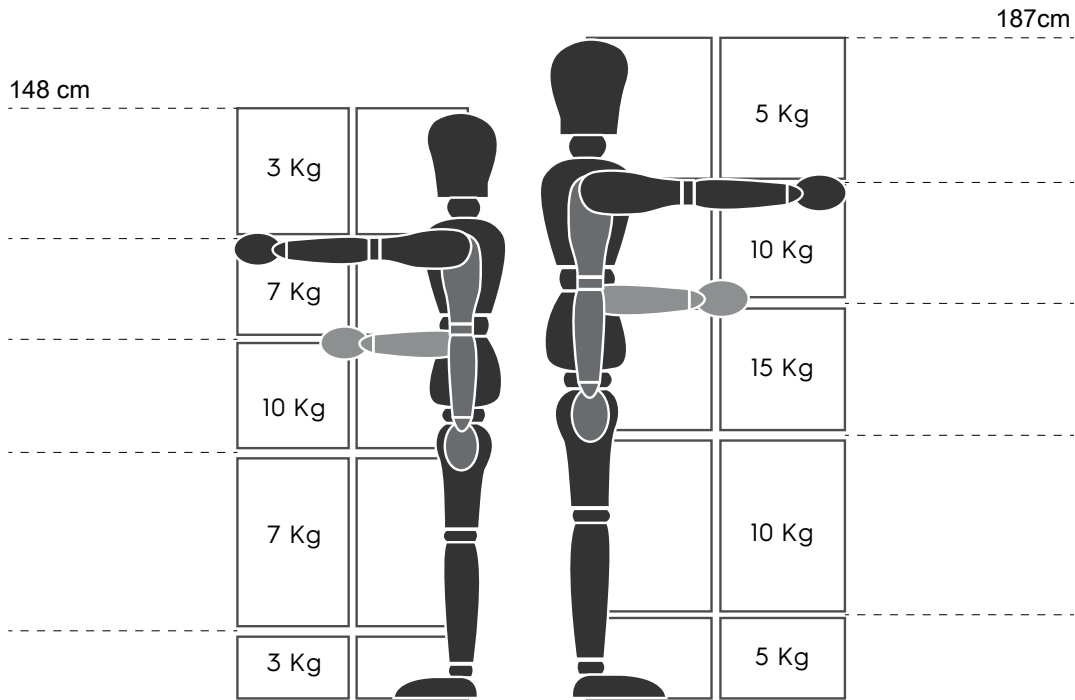

Maximum suggested weighs - "Manual Handling Operations Regulations" - Health and Safety Executive (HSE, UK, 2016)

Below a few examples of common installations and the maximum suggested weights per trays

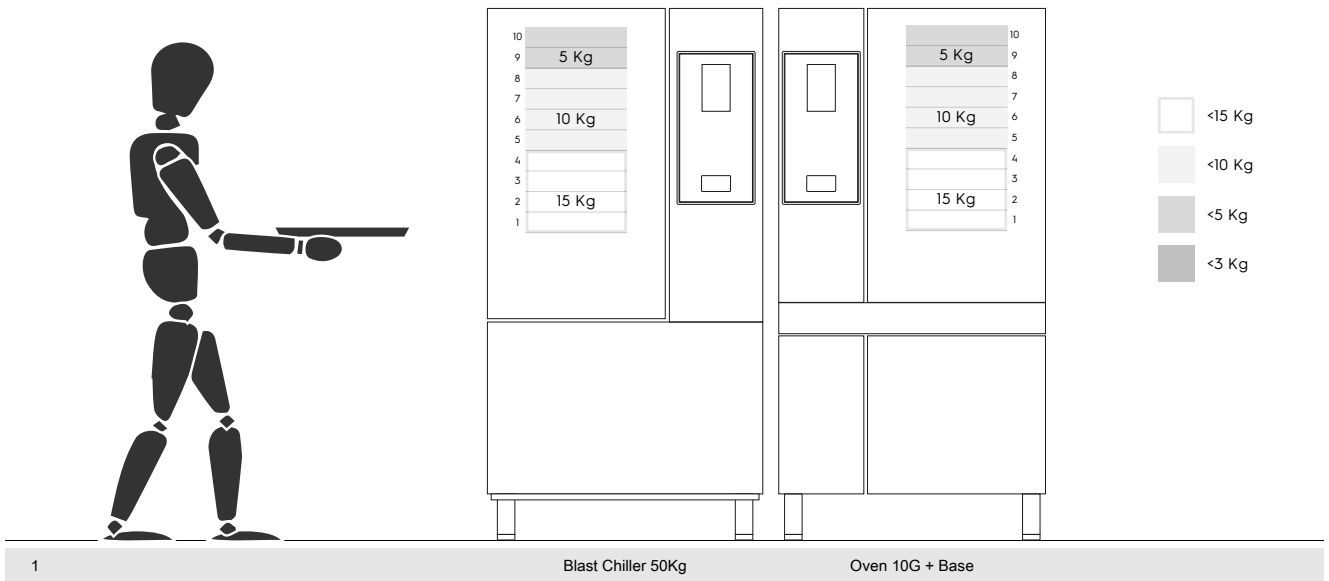



I.1.2.1 Recommendations on accessories

- For the installation of the 20GN 2/1 Blast Chiller it is suggested the predisposition of the isolated floor to avoid extra strain for the operator who uses the Mobile GastroNorm rack.
- For the wall installation of the 10GN it is suggested the use the Riser accessory not higher than 700 mm to improve easiness of loading.
- In the stacking installation 6GN + 6GN it is suggested to use the adjustable feet accessory 230-290mm (code 922745) and set them at maximum height of 290 mm to facilitate an easy loading.
- In the configuration 6GN + 6GN on Riser accessory it is suggested to load trays with a weight lower than 3 Kg on upper level.

CE