

Vertical refrigerators

Premium

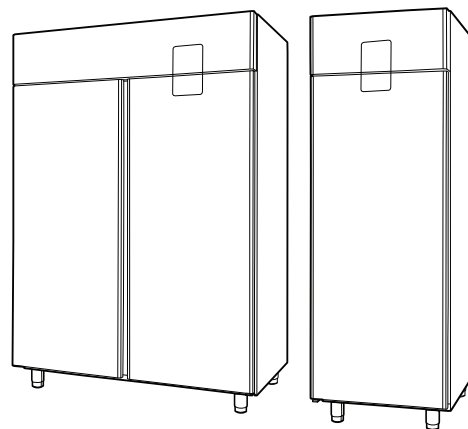

EN User manual *



*Original instructions

595R80200- 2024.04

Foreword

 Read the following instructions, including the warranty terms before installing and using the appliance.

Visit our website www.electroluxprofessional.com and open the Support section to:

 Register your product

 Get hints & tips of your product, service and repair information

The installation, use and maintenance manual (hereinafter Manual) provides the user with information necessary for correct and safe use of the appliance.

The following must not be considered a long and exacting list of warnings, but rather a set of instructions suitable for improving appliance performance in every respect and, above all, preventing injury to persons and animals and damage to property due to improper operating procedures.

All persons involved in appliance transport, installation, commissioning, use and maintenance, repair and disassembly must consult and carefully read this manual before carrying out the various operations, in order to avoid wrong and improper actions that could compromise the appliance's integrity or endanger people. Make sure to periodically inform the user regarding the safety regulations. It is also important to instruct and update personnel authorised to operate on the appliance, regarding its use and maintenance.

The manual must be available to operators and carefully kept in the place where the appliance is used, so that it is always at hand for consultation in case of doubts or whenever required.

If, after reading this manual, there are still doubts regarding appliance use, do not hesitate to contact the Manufacturer or the authorised Service Centre to receive prompt and precise assistance for better operation and maximum efficiency of the appliance. During all stages of appliance use, always respect the current regulations on safety, work hygiene and environmental protection. It is the user's responsibility to make sure the appliance is started and operated only in optimum conditions of safety for people, animals and property.

IMPORTANT

- The manufacturer declines any liability for operations carried out on the appliance without respecting the instructions given in this manual.
- The manufacturer reserves the right to modify the appliances presented in this publication without notice.
- No part of this manual may be reproduced.
- This manual is available in digital format by:
 - contacting the dealer or reference customer care;
 - downloading the latest and up to date manual on the web site www.electroluxprofessional.com;
- The manual must always be kept in an easily accessed place near the appliance. Appliance operators and maintenance personnel must be able to easily find and consult it at any time.

Contents

A	WARNING AND SAFETY INFORMATION	4
A.1	General information	4
A.2	Personal protection equipment	4
A.3	General safety	5
A.4	Protection devices installed on the appliance	5
A.5	Safety signs to be placed on the appliance or near its area	6
A.6	Reasonably foreseeable improper use	6
A.7	Residual risks	6
A.8	Product loading and unloading	7
A.9	Maximum load	7
A.10	Appliance cleaning	7
A.11	Cleaning the cabinet and accessories	7
A.12	Preventive Maintenance	7
A.13	Parts and accessories	7
A.14	Precautions for use and maintenance	7
A.15	Appliance maintenance	8
A.16	Maintenance intervals	8
B	APPLIANCE AND MANUFACTURER'S IDENTIFICATION DATA	8
C	WARRANTY TERMS AND EXCLUSIONS	9
D	GENERAL INFORMATION	9
D.1	Introduction	9
D.2	Intended use and restrictions	9
D.3	Testing and inspection	9
D.4	Copyright	9
D.5	Keeping the manual	10
D.6	Recipients of the manual	10
D.7	Definitions	10
D.8	Responsibility	10
E	NORMAL MACHINE USE	10
E.1	Characteristics of personnel enabled to operate on the appliance	10
E.2	Basic requirements for appliance use	10
F	OPERATING	11
F.1	Description of control panel	11
G	INSTRUCTION FOR THE USER	11
G.1	Switching on the appliance	11
G.2	Temperature setting	11
G.3	Humidity setting	12
G.4	Continuous cycle	12
G.5	Signalling icons	13
G.6	Alarms and signalling	13
G.7	Defrost	13
G.8	Internal light	13
G.9	Loading the product	13
H	APPLIANCE SETTINGS FROM A MOBILE DEVICE APPLICATION	14
H.1	Appliance setting via Bluetooth	14
H.2	Main menu drawer	14
H.3	Main buttons	16
H.4	Signalling icons	17
H.5	Temperature setpoint	17
H.6	Humidity setpoint level	17
H.7	Device daytime button	17
H.8	Event Log button	18
	H.8.1 Log (data in progress)	18
	H.8.2 Events (history data view)	19
H.9	Alarms	20
I	MACHINE CLEANING AND MAINTENANCE	21
I.1	Ordinary maintenance	21
	I.1.1 Care information	21
	I.1.2 Cleaning introduction	21
	I.1.3 Compartment cleaning	21
	I.1.4 Periods of non-use	21
J	TROUBLESHOOTING	22
J.1	Introduction	22
J.2	Troubleshooting	22

A WARNING AND SAFETY INFORMATION

A.1 General information

To ensure safe use of the appliance and a proper understanding of the manual it is necessary to be familiar with the terms and typographical conventions used in the documentation. The following symbols are used in the manual to indicate and identify the various types of hazards:

 **WARNING**
Danger for the health and safety of operators.

 **WARNING**
Danger of electrocution - dangerous voltage.

 **CAUTION**
Risk of damage to the appliance or the product.

 **WARNING**
Risk of fire / Flammable materials

 Pressure

 **IMPORTANT**
Important instructions or information on the product





 Read the instructions before using the appliance





 Clarifications and explanations

- Only specialised personnel are authorised to operate on the appliance.
- This appliance is not intended for use by persons (including children) with reduced physical, sensory or mental capabilities, or lack of experience and knowledge, unless they have been given supervision or instruction concerning use of appliance by a person responsible for their safety.
- (ONLY FOR EUROPE) This appliance can be used by children aged from 8 years and above and persons with reduced physical, sensory or mental capabilities or lack of experience and knowledge if they have been given supervision or instruction concerning use of the appliance in a safe way and understand the hazards involved.
- Children should be supervised to ensure that they do not play with the appliance.
- Keep all packaging and detergents away from children.
- Cleaning and user maintenance shall not be made by children without supervision.
- For your safety do not store or use gasoline or other flammable materials, vapours and liquids in the vicinity of this or any other appliance.
- Do not store explosive substances, such as pressurized containers with flammable propellant, in this appliance.
- Refer to the data given on the appliance's data plate for relations with the Manufacturer (e.g. when ordering spare parts, etc.).
- When scrapping the appliance, the marking must be destroyed.
- Save these instructions carefully for further consultation by the various operators.

A.2 Personal protection equipment

Summary table of the Personal Protection Equipment (PPE) to be used during the various stages of the machine's service life.

Stage	Protective garments 	Safety footwear 	Gloves 	Glasses 	Safety helmet 
Transport	—	●	○	—	○
Handling	—	●	○	—	—
Unpacking	—	●	—	—	—
Installation	—	●	—	—	—
Normal use	—	—	—	—	—
Routine cleaning	—	—	—	—	—

Stage	Protective garments	Safety footwear	Gloves	Glasses	Safety helmet
					
Extraordinary cleaning		●			—
Maintenance		●			—
Dismantling		●			—
Scrapping		●			—
Key:					
●	PPE REQUIRED				
○	PPE AVAILABLE OR TO BE USED IF NECESSARY				
—	PPE NOT REQUIRED				

A.3 General safety

- The appliances are provided with electric and/or mechanical safety devices for protecting workers and the appliance itself.
- Never operate the appliance, removing, modifying or tampering with the guards, protection or safety devices.
- Do not make any modifications to the parts supplied with the appliance.
- Several illustrations in the manual show the appliance, or parts of it, without guards or with guards removed. This is purely for explanatory purposes. Do not use the appliance without the guards or with the protection devices deactivated.

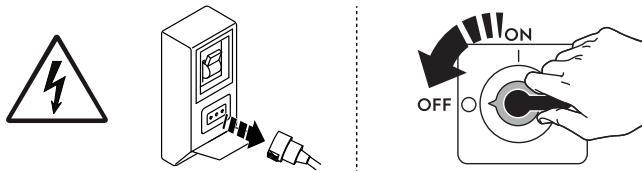

Disconnect the appliance from the power supply before carrying out any installation, assembly, cleaning or maintenance procedure.

- Do not remove, tamper with or make illegible the marking and safety, danger and instruction signs and labels on the appliance.
- The A-weighted emission sound pressure level does not exceed 70 dB(A).¹
- Carefully avoid exposure of the equipment to ozone - do not use ozonizers in the rooms where the equipment is installed.
- The following operations have to be carried out by specialised authorised personnel or Customer Care Service provided with all the appropriate personal protection equipment (A.2 *Personal protection equipment*), tools, utensils and ancillary means, who can ask the manufacturer to supply a servicing manual:
 - Installation and assembly
 - Installation of the refrigerant fluid condensing unit
 - Positioning
 - Electrical connection
 - Appliance cleaning, repair and extraordinary maintenance
 - Appliance disposal
 - Work on electrical equipment
 - Dismantling operations of appliances which use R290 or R-744 (with a refrigeration system under high pressure)
 - Dismantling operations of appliances which use flammable insulation blowing gases;

A.4 Protection devices installed on the appliance





Guards

The appliance has:

- fixed guards (e.g. casings, covers, side panels, etc.), fixed to the appliance and/or frame with screws or quick-release connectors that can only be removed or opened with tools; therefore the user must not remove or tamper with such devices. The Manufacturer declines any liability for damage due to tampering or their non-use;
- interlocked movable guards (door) for access inside the appliance;
- appliance electrical equipment access panels or doors, made from hinged panels openable with tools. The panel or the door must not be opened when the appliance is connected to the power supply.

1. The noise emission values have been obtained according to EN ISO 11204. The value could increase depending on the workplace where measured.

A.5 Safety signs to be placed on the appliance or near its area

Prohibition	Meaning
	do not remove the safety devices
	do not use water to extinguish fires (placed on electrical parts)
Danger	Meaning
	caution hot surface
	danger of electrocution (shown on electrical parts with indication of voltage)

A.6 Reasonably foreseeable improper use

Improper use is any use different from that specified in this manual. During appliance operation, other types of work or activities deemed improper and that in general can involve risks for the safety of operators and damage to the appliance are not allowed. Reasonably foreseeable improper use includes:

- lack of appliance maintenance, cleaning and periodical checks;
- structural changes or modifications to the operating logic;
- tampering with the guards or safety devices;
- failure to use personal protection equipment by operators, specialised personnel and maintenance personnel;
- failure to use suitable accessories (e.g. use of unsuitable equipment or ladders);
- keeping combustible or flammable materials, or in any case materials not compatible with or pertinent to the work, near the appliance;
- wrong appliance installation;
- placing in the appliance any objects or things not compatible with its use, or that can damage the appliance, cause injury or pollute the environment;
- climbing on the appliance;
- non-compliance with the requirements for correct appliance use;
- other actions that give rise to risks not eliminable by the Manufacturer.
- failure to insure complete closure of doors or drawers, through forgetfulness or carelessness
- place the product in the compartments so as to block proper air circulation or hinder the perfect closing of doors / drawers
- exceed product weight allowed for each shelf / drawer

A.7 Residual risks

The appliance has several risks that were not completely eliminated from a design standpoint or with the installation of adequate protection devices. Nevertheless, through this manual the Manufacturer has taken steps to inform operators of such risks, carefully indicating the personal protection equipment to be used by them. In order to reduce the risks, provide for sufficient spaces while installing the unit.

To preserve these conditions, the areas around the appliance must always be:

- kept free of obstacles (e.g. ladders, tools, containers, boxes, etc.);
- clean and dry;
- well lit.

For the Customer's complete information, the residual risks remaining on the appliance are indicated below: such actions are deemed improper and therefore strictly forbidden.

Residual risk	Description of hazardous situation
Slipping or falling	The operator can slip due to water, any liquid or dirt on the floor
Burns/abrasions (e.g. heating elements, cold pan, cooling circuit plates and pipes)	The operator deliberately or unintentionally touches some components inside the appliance without using protective gloves.
Electrocution	Contact with live parts during maintenance operations carried out with the electrical panel powered
Falling from above	The operator intervenes on the appliance using unsuitable systems to access the upper part (e.g. rung ladders, or climbs on it)
Crushing or injury	The specialised personnel may not correctly fix the control panel when accessing the technical compartment. The panel could close suddenly.

Residual risk	Description of hazardous situation
Tipping of loads	When handling the appliance or the packing containing it, using unsuitable lifting systems or accessories or with the unbalanced load
Chemical (refrigerant gas)	Inhalation of refrigerant gas. Therefore always refer to the appliance labels
Sudden closure	The operator for normal appliance use could suddenly and deliberately close the door/drawers (if present, depending on the appliance type).

A.8 Product loading and unloading

- Cover or wrap food before placing it in the refrigerator and avoid putting very hot foods or steaming liquids inside.
- Do not use spray products for defrosting; in fact, they can be harmful to the health and/or damage the materials the appliance is made from.

WARNING:

- Do not use mechanical devices or other means to speed up the defrost process, unless recommended by the manufacturer.
- Do not damage the refrigerant circuit.
- Do not use electrical appliances inside the appliance compartments for storing frozen food, unless such equipment is recommended by the manufacturer.
- Keep the ventilation openings in the appliance casing free of any obstructions.

A.9 Maximum load

Regarding the maximum load for each appliance and each shelf, respect that given in the table below:

SHELF MAXIMUM LOAD	40 KG
--------------------	-------

A.10 Appliance cleaning

- Do not touch the appliance with wet hands or feet or when barefoot.
- Use a ladder with suitable protection for work on appliances with high accessibility.
- Put the appliance in safe conditions before starting any cleaning operation.
- Respect the requirements for the various routine and extraordinary maintenance operations. Non-compliance with the instructions can create risks for personnel.
- Do not spray water or use water jets, steam cleaner or high pressure cleaner.

A.11 Cleaning the cabinet and accessories

- Pay attention to the selection and use of cleaning products in order to maintain proper appliance performance and safeness.
- Before using the appliance, clean all the internal parts and accessories with lukewarm water and neutral soap, or products that are over 90% biodegradable (in order to reduce the emission of pollutants into the environment), then rinse and dry thoroughly, where possible clean with dishwashing appliance.
- Do not clean the appliance with detergents containing chlorine, solvent-based cleaning products (e.g. trichloro-ethylene), abrasive powders or agents, scouring pads or sponges that could damage the surfaces. Do not use organic solvent substances or essential oils. These substances could damage the parts of the appliance made from synthetic material.
- Do not use products (even if diluted) containing chlorine (sodium hypochlorite, hydrochloric or muriatic acid, etc.) to clean the floor under the appliance.

A.12 Preventive Maintenance

In order to ensure the safety and performance of your equipment, it is recommended that service is undertaken by Electrolux Professional SpA authorised engineers every 12 months, in accordance with Electrolux Professional SpA Service Manuals. Please contact your local Electrolux Professional SpA Service Centre for further details.

A.13 Parts and accessories

Use only original accessories and/or spare parts. Failure to use original accessories and/or spare parts will invalidate the original manufacturer warranty and may render the appliance not compliant with the safety standard.

A.14 Precautions for use and maintenance

- Risks mainly of a mechanical, thermal and electrical nature exist in the appliance. Where possible the risks have been neutralised:
 - directly, by means of adequate design solutions.
 - indirectly by using guards, protection and safety devices.
- Any anomalous situations are signalled on the control panel display.
- During maintenance several risks remain, as these could not be eliminated, and must be neutralised by adopting specific measures and precautions.
- Do not carry out any checking, cleaning, repair or maintenance operations on moving parts. Workers must be informed of this prohibition by means of clearly visible signs.
- Make sure to periodically check correct operation of all the safety devices and the insulation of electrical cables, which must be replaced if damaged.

In case of a significant anomaly (e.g. short circuits, wires coming out of the terminal block, motor breakdowns, worn electrical cable sheathing, etc.) the operator for normal appliance use must:

- immediately deactivate the appliance.

A.15 Appliance maintenance

- The inspection and maintenance intervals depend on the actual appliance operating conditions and ambient conditions (presence of dust, damp, etc.), therefore precise time intervals cannot be given. In any case, careful and periodical appliance maintenance is advisable in order to minimise service interruptions.
- It is advisable to stipulate a preventive and scheduled maintenance contract with the Customer Care Service.
- Put the appliance in safe conditions before starting any maintenance operation.
- To guarantee appliance efficiency and correct operation, periodical maintenance must be carried out according to the instructions given in the manual.

A.16 Maintenance intervals

It is advisable to carry out the checks with the frequency given in the following table:

Maintenance, inspections, checks and cleaning	Frequency	Responsibility
Ordinary cleaning • general cleaning of appliance and surrounding area	• Daily	• Operator
Mechanical protection devices • check their condition and for any deformation, loosening or removed parts	• Yearly	• Service
Door frame and Gasket • Check the integrity status of the door frame and door gasket. Check the cleanliness of the door frame and door gasket. Replace in case broken.	• Monthly	• Operator
Control • check the mechanical parts, for cracks or deformations, tightening of screws: check the readability and condition of words, stickers and symbols and restore if necessary	• Yearly	• Service
Appliance structure • tightening of main bolts (screws, fixing systems, etc.) of appliance	• Yearly	• Service
Safety signs • check the readability and condition of safety signs	• Yearly	• Service
Electrical control panel • check the electrical components installed inside the electrical control panel. Check the wiring between the electrical panel and appliance parts	• Yearly	• Service
Electrical connection cable • check the connection cable (replace if necessary)	• Yearly	• Service
General appliance overhaul • check all components, electrical equipment, corrosion, pipes...	Every 10 years ¹	• Service

1. The appliance is designed and built for a duration of about 10 years. After this period of time (from commissioning) the appliance must undergo a general inspection and overhaul.

B APPLIANCE AND MANUFACTURER'S IDENTIFICATION DATA

The data plate gives the product identification and technical data.

An example of the marking or data plate on the appliance is given below:

F.Mod. XXXXXXXXX	Comm. Model XXXXXXXXX	Type ref. XXXXXX	2019
PNC 9VTXXXXXXXXXX	Ser. Nr. XXXXXXXX	Cyclopentane	
W Tot. XXX kW	Volt XXXV XXX XX	Hz	Total Current XX A
Potenza Sbrinatorio / Defrost Power	XXX kW	Classe / Class X	GIWFXXXX CO2-eq XXX t
Resistenza Evaporazione / Evaporation Heater El.	X kW	Refrigerante / Refrigerant XXXXX	XX Kg
Illuminazione / Lighting	X W	Cap. X	
IPxx		CE	
Electrolux Professional SPA - Viale Treviso, 15 - 33170 Pordenone (Italy)			

The meaning of the various information given on it is listed below:

F.Mod.	factory description of product
Comm.Mod.	commercial description
PNC	production number code
Ser.No.	serial number
Type ref.	certification group of the appliance
Cyclopentane	expanding gas used in insulation
V	power supply voltage
Hz	power supply frequency

kW	power input
A	absorbed current
Evaporation heater El.	evaporation heating element power
Class	climatic class
GWP	global warming potential
CO2 eq	quantity of greenhouse gases
Lighting	internal light
Cap.	nominal capacity

Refrigerant	type of refrigerant gas
Defrost power	current absorbed
CE	CE marking
	WEEE symbol
IPX3	dust and water protection rating

C WARRANTY TERMS AND EXCLUSIONS

If the purchase of this product includes warranty coverage, warranty is provided in line with local regulations and subject to the product being installed and used for the purposes as designed, and as described within the appropriate equipment documentation.

Warranty will be applicable where the customer has used only genuine spare parts and has performed maintenance in accordance with Electrolux Professional user and maintenance documentation made available in paper or electronic format.

Electrolux Professional strongly recommends using Electrolux Professional approved cleaning, rinse and descaling agents to obtain optimal results and maintain product efficiency over time.

The Electrolux Professional warranty does not cover:

- service trips cost to deliver and pick up the product;
- installation;
- training on how to use/operate;
- replacement (and/or supply) of wear and tear parts unless resulting from defects in materials or workmanship reported within one (1) week from the failure;
- correction of external wiring;
- correction of unauthorized repairs as well as any damages, failures and inefficiencies caused by and/or resulting from;
 - insufficient and/or abnormal capacity of the electrical systems (current/voltage/frequency, including spikes and/or outages);
 - inadequate or interrupted water supply, steam, air, gas (including impurities and/or other that does not comply with the technical requirements for each appliance);
 - plumbing parts, components or consumable cleaning products that are not approved by the manufacturer;
- customer's negligence, misuse, abuse and/or non-compliance with the use and care instructions detailed within the appropriate equipment documentation;
- improper or poor: installation, repair, maintenance (including tampering, modifications and repairs carried out by third parties not authorized) and modification of safety systems;
- Use of non-original components (e. g.: consumables, wear and tear, or spare parts);
- environment conditions provoking thermal (e. g. overheating/freezing) or chemical (e. g. corrosion/oxidation) stress;
- foreign objects placed in- or connected to- the product;
- accidents or force majeure;
- transportation and handling, including scratches, dents, chips, and/or other damage to the finish of the product, unless such damage results from defects in materials or workmanship and is reported within one (1) week of delivery unless otherwise agreed;

- product with original serial numbers that have been removed, altered or cannot be readily determined;
- replacement of light bulbs, filters or any consumable parts;
- any accessories and software not approved or specified by Electrolux Professional.

Electrolux Professional warranty will be void and manufacturer shall have no liability related thereto in case of any modification of the product or related hardware/software/programming.

Warranty does not include scheduled maintenance activities (including the parts required for it) or the supply of cleaning agents unless specifically covered within any local agreement, subject to local terms and conditions.

Check on Electrolux Professional website the list of authorized customer care.

D GENERAL INFORMATION



WARNING

Refer to “Warning and Safety Information”.

D.1 Introduction

This manual contains information relevant to various appliances. The product images in this guide are only an example.

The drawings and diagrams given in the manual are not in scale. They supplement the written information with an outline, but are not intended to be a detailed representation of the appliance supplied.

The numerical values given on the appliance installation diagrams refer to measurements in millimeters and/or inches.

D.2 Intended use and restrictions

This appliance is designed for the refrigeration and preservation of foods.

Any other use is deemed improper.



NOTE!

The manufacturer declines any liability for improper use of the product.

D.3 Testing and inspection

Our appliances have been designed and optimized, with laboratory testing, in order to obtain high performance and efficiency.

The appliance is shipped ready for use.

Passing of the tests (visual inspection - electrical test - functional test) is guaranteed and certified by the specific enclosures.

D.4 Copyright

This manual is intended solely for consultation by the operator and can only be given to third parties with the permission of Electrolux Professional SpA company.

D.5 Keeping the manual

The manual must be carefully kept for the entire life of the appliance, until scrapping. The manual must stay with the appliance in case of transfer, sale, hire, granting of use or leasing.

D.6 Recipients of the manual

This manual is intended for:

- the employer of appliance users and the workplace manager;
- operators for normal appliance use;
- specialised personnel - Customer Care service (see service manual).

D.7 Definitions

Listed below are the definitions of the main terms used in the manual. It is advisable to read them carefully before use.

Operator	appliance installation, adjustment, use, maintenance, cleaning, repair and transport personnel.
Manufacturer	Electrolux Professional SpA or any other service centre authorised by Electrolux Professional SpA.
Operator for normal appliance use	an operator who has been informed and trained regarding the tasks and hazards involved in normal appliance use.
Customer Care service or specialised personnel	an operator instructed/trained by the Manufacturer and who, based on his professional and specific training, experience and knowledge of the accident-prevention regulations, is able to appraise the operations to be carried out on the appliance and recognise and prevent any risks. His professionalism covers the mechanical, electrotechnical and electronics fields etc.
Danger	source of possible injury or harm to health.
Hazardous situation	any situation where an operator is exposed to one or more hazards.
Risk	a combination of probabilities and risks of injury or harm to health in a hazardous situation.
Protection devices	safety measures consisting of the use of specific technical means (guards and safety devices) for protecting operators against risks.

Guard	an element of a appliance used in a specific way to provide protection by means of a physical barrier.
Safety device	a device (other than a guard) that eliminates or reduces the risk; it can be used alone or in combination with a guard.
Customer	the person who purchased the appliance and/or who manages and uses it (e. g. company, entrepreneur, firm).
Electrocution	an accidental discharge of electric current on a human body.

D.8 Responsibility

The Manufacturer declines any liability for damage and malfunctioning caused by:

- non-compliance with the instructions contained in this manual;
- repairs not carried out in a workmanlike fashion, and replacements with parts different from those specified in the spare parts catalogue (the fitting and use of non-original spare parts and accessories can negatively affect appliance operation and invalidates the original manufacturer warranty);
- operations carried out by non-specialised personnel;
- unauthorized modifications or operations;
- missing, lack or inadequate maintenance;
- improper appliance use;
- unforeseeable extraordinary events;
- use of the appliance by uninformed and / or untrained personnel;
- non-application of the current provisions in the country of use, concerning safety, hygiene and health in the workplace.

The Manufacturer declines any liability for damage caused by arbitrary modifications and conversions carried out by the user or the Customer.

The employer, workplace manager or service technician are responsible for identifying and choosing adequate and suitable personal protection equipment to be worn by operators, in compliance with regulations in force in the country of use.

The Manufacturer declines any liability for inaccuracies contained in the manual, if due to printing or translation errors.

Any supplements to the installation, use and maintenance manual the Customer receives from the Manufacturer will form an integral part of the manual and therefore must be kept together with it.

E NORMAL MACHINE USE

E.1 Characteristics of personnel enabled to operate on the appliance

The Customer must make sure the personnel for normal appliance use are adequately trained and skilled in their duties. The operator must:

- read and understand the manual;
- receive adequate training and instruction for their duties in order to operate safely;
- receive specific training for correct appliance use.



IMPORTANT

The Customer must make sure his personnel have understood the instructions received and in particular those regarding work hygiene and safety in use of the appliance.

E.2 Basic requirements for appliance use

- Knowledge of the technology and specific experience in operating the appliance.
- Adequate general basic education and technical knowledge for reading and understanding the contents of the manual, including correct interpretation of the drawings, signs and pictograms.
- Sufficient technical knowledge for safely performing his duties as specified in the manual.
- Knowledge of the regulations on work hygiene and safety.

F OPERATING

F.1 Description of control panel

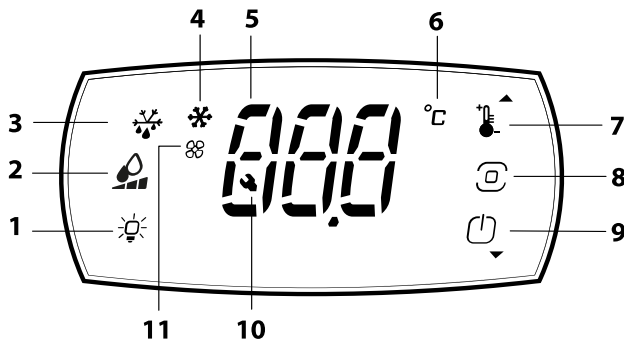

1	INTERNAL LIGHT BUTTON ¹ It allows to switch on/off the inside light.
2	HUMIDITY BUTTON ² It allows to set 3 different humidity levels

3	DEFROST CYCLE ACTIVATION ICON/BUTTON
4	COMPRESSOR ON SIGNALLING ICON
5	DISPLAY
6	UNIT OF MEASURE °C/°F
7	TEMPERATURE BUTTON / UP ARROW It allows to access the Set point and increase the values.
8	PROGRAM BUTTON Pressed briefly It allows to save value; Pressed for 3 seconds it allows to unlock keypad and enter programming mode.
9	ON-OFF BUTTON / DOWN ARROW for decreasing the values. It allows to activate-deactivate the appliance
10	ALARM SIGNALLING ICON
11	COMPARTMENT FANS ON SIGNALLING ICON

1. if present
2. present only in refrigerated models

G INSTRUCTION FOR THE USER

G.1 Switching on the appliance

Connect the power cable to a power socket. The instrument display performs a Lamp Test and for a few seconds the display shows the compressor icon flashes, until the compressor starts.



To activate and deactivate the appliance touch Program button for 3 seconds to unlock the display

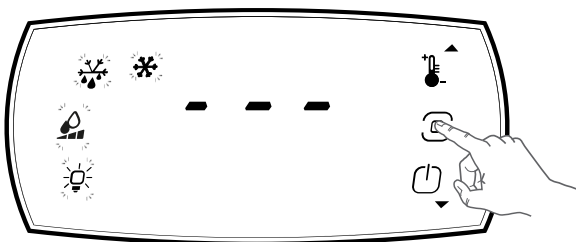

and then touch ON/OFF button ;

The display will show the message ON (for activation) or alternately the message OFF and the compartment temperature (for deactivation).

Even if the machine is deactivated with the ON/OFF button it still remains powered.

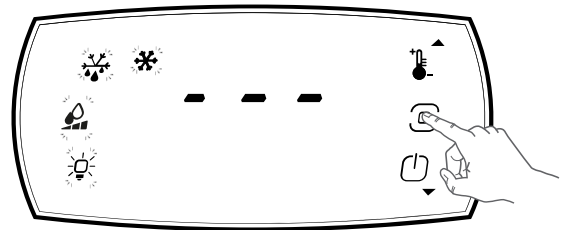

G.2 Temperature setting

- Touch Program button for 3 seconds to unlock the display;

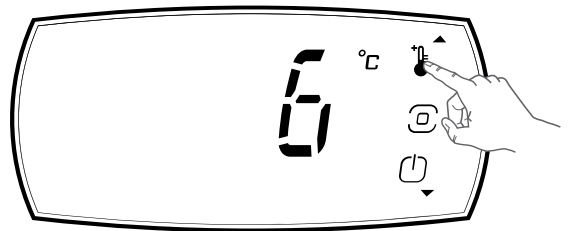

- Press the temperature button.
The display shows the SET POINT.



- Press the UP arrow  or the DOWN arrow  to change the SET value;
- Touch Program button to confirm the change.

If no button is pressed for 20 seconds (TIME OUT), the digital thermostat memorises the last set value and the normal display is restored.

The temperature range is set from a minimum to a maximum, according to the following values:

Refrigerated models with fully insulated door	-2/+10
Refrigerated models with glass door	+2/+10
Freezer models with fully insulated door	-22/-15

Freezer models with glass door	-20/-15
Refrigerated models with separate compartments	-2/+10 -2/+10
Refrigerated/freezer models with separate compartments	-2/+10 -22/-15
Refrigerated models with separate compartments and 3 doors	-2/+10 -2/+6

G.3 Humidity setting

(refrigerated models only)

It is possible to set 3 different humidity levels.

Humidity varies on the base of the ambient temperature and the cell temperature (Set point).

There are 3 humidity levels:

- low humidity - 30%
- medium humidity - 60%
- high humidity - 90%

Table of categories, compartment temperature and humidity setting

Categories	Temperature (°C)	Humidity
Fresh meat (beef, mutton, pork)	4	high humidity
Poultry	-2	high humidity
Fruit & Vegetables	6	high humidity
Eggs, Butter, Cheese, Charcuterie	6	high humidity
Fresh fish	4	high humidity
Patisserie	6	high humidity
Beverages	8	medium humidity

To change humidity level proceed as follow:

- Touch Program button for 3 seconds to unlock the display;

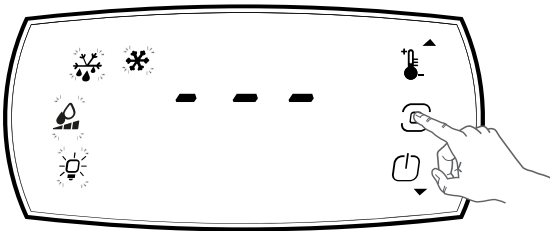

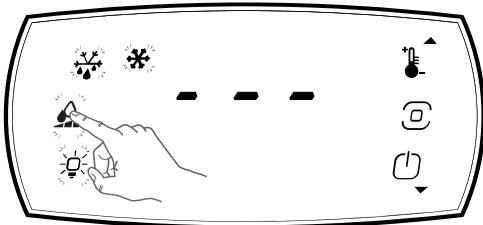

- Press the Humidity button.

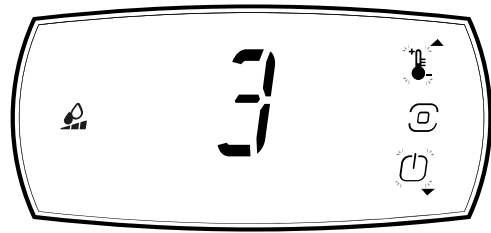

- The display shows the set point.



- Press the UP arrow  or the DOWN arrow  to change the SET value;

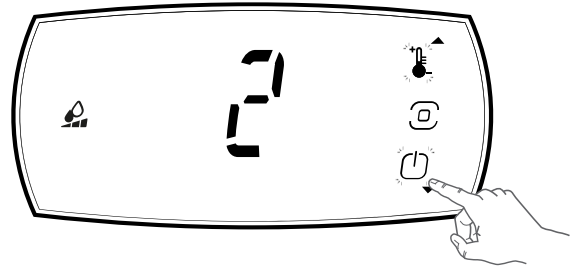

- Touch Program button to confirm the change.
If no button is pressed for 20 seconds (TIME OUT), the digital thermostat memories the last set value and the normal display is restored.

G.4 Continuous cycle

If Continuous Cycle is active, the display shows the parameter **CnC**

To activate or deactivate the cycle proceed as follow:

- Touch Program button for 3 seconds to unlock the display;

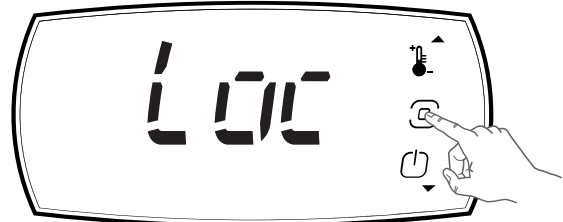

- Touch Program button again

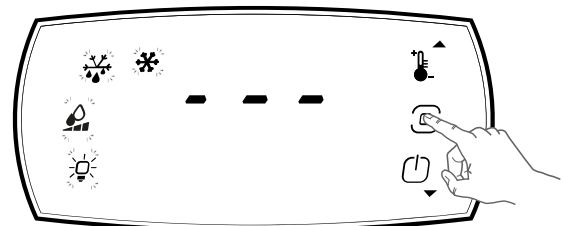

- and find **CnC** parameter (with UP/DOWN arrows);

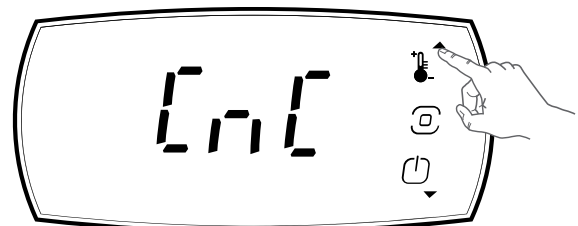

- Touch Program button

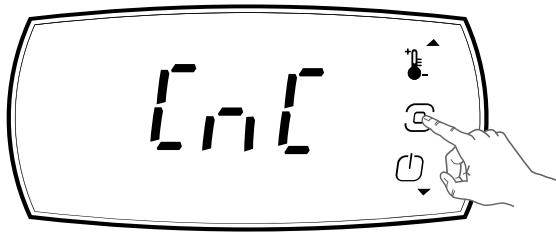

- and choose On or OFF (with UP/DOWN arrows);



- Confirm the selection with program button;
- If no button is pressed for 20 seconds the normal display is restored.

G.5 Signalling icons

	lit up	This icon indicates compressor activation.
	lit up	This icon indicates defrost function in progress.
	lit up	This icon indicates activation of compartment fans.
	lit up	This icon indicates that a alarm has occurred during appliance operation.

G.6 Alarms and signalling

The alarm is signalled by lighting up of the icon

Alarm signalling is also indicated by the alarm code appearing on the display (see section J.2 *Troubleshooting*).

Example: Alarm signalling due to a faulty probe (compartment probe) appears directly on the instrument display with the message E0 and rE flashing alternately.

Press any button to mute the buzzer.

When the alarm condition ceases, the alarm goes off. Otherwise, contact the Customer Care Service.

G.7 Defrost

Automatic defrost

The appliance has an automatic defrost function. This function is signalled by lighting up of the icon . The defrost water is run into a tray and automatically evaporated.

Manual activation of defrost

- Touch Program button for 3 seconds to unlock the display;

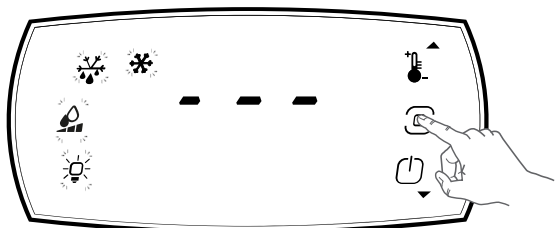

- Press defrost button to start a manual defrost cycle.

Defrost can be stopped manually at any time by pressing again the button ; the display shows the message dFE. Defrost cannot be activated in the programming stage.

G.8 Internal light

If present the internal light button , it is possible to switch on/off the inside light.

Unlock the display by touching the Program button for 3 seconds and then switch on/off the internal light.

G.9 Loading the product



WARNING

Cover or wrap food before placing it in the refrigerator and avoid putting very hot foods or steaming liquids inside.

Distribute the product evenly inside the compartment (away from the door and back) to allow good air circulation. In case of excessive product loading, the temperature remains uniform thanks to the removable rear supports which act as an air conveyor.

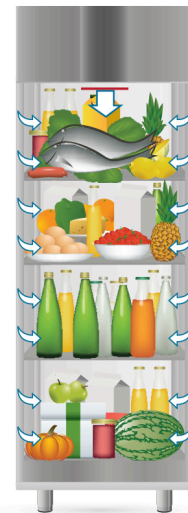

CAUTION

Do not place the product directly on bottom. Use the specific provided rack.

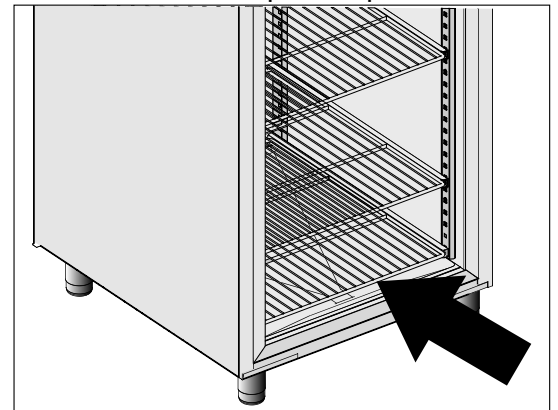

Do not leave the door open any longer than necessary when loading or removing food.

It is advisable to keep the keys in a place only accessible to authorised personnel. To prevent unauthorised personnel from

opening the appliance, it is advisable to always close it with the key.

H APPLIANCE SETTINGS FROM A MOBILE DEVICE APPLICATION

H.1 Appliance setting via Bluetooth

1. **SCAN THE QR CODE** on the first page of the guide provided with the appliance;
2. **Download the application** (follow the instructions on the website);
3. **Connect Bluetooth**;
4. **Open the application**;

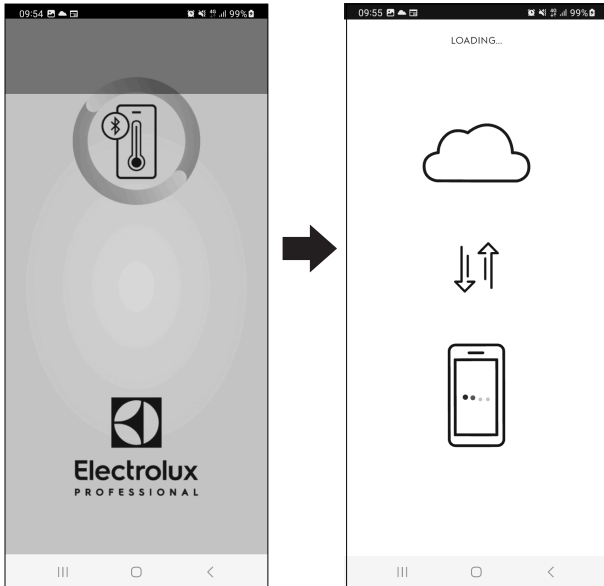

5. **Select the available appliance**;

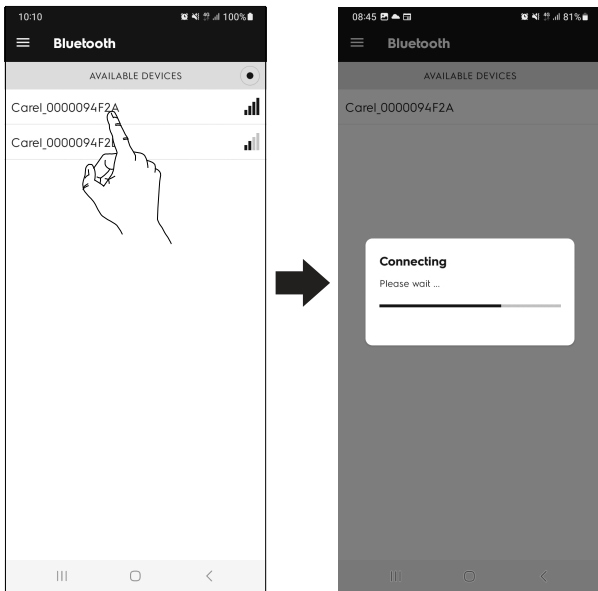

6. The mobile device display shows the Starting page:

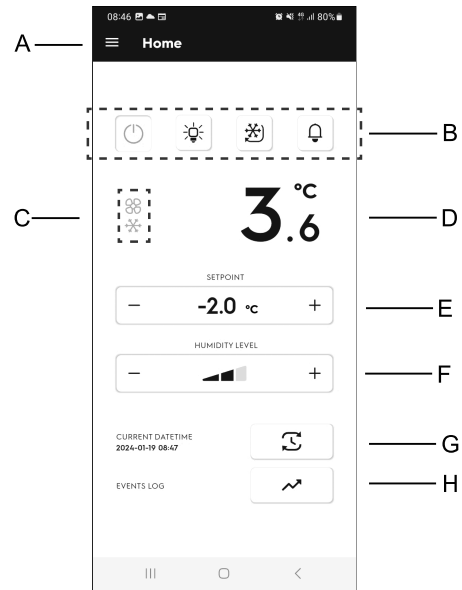

- A. Main menu drawer
- B. Main buttons
- C. Signalling icons
- D. Cavity temperature
- E. Temperature setpoint
- F. Humidity setpoint level
- G. Device daytime button
- H. Event Log button

The appliance display shows the bluetooth connection.

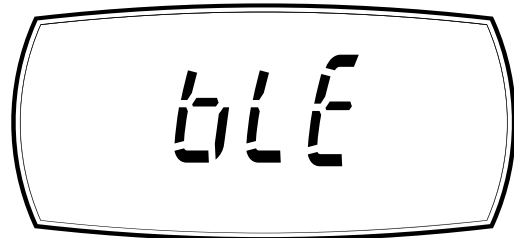

H.2 Main menu drawer

The main menu drawer contains options and functions.

Open the drawer and touch the required icon to access inside the different modes.

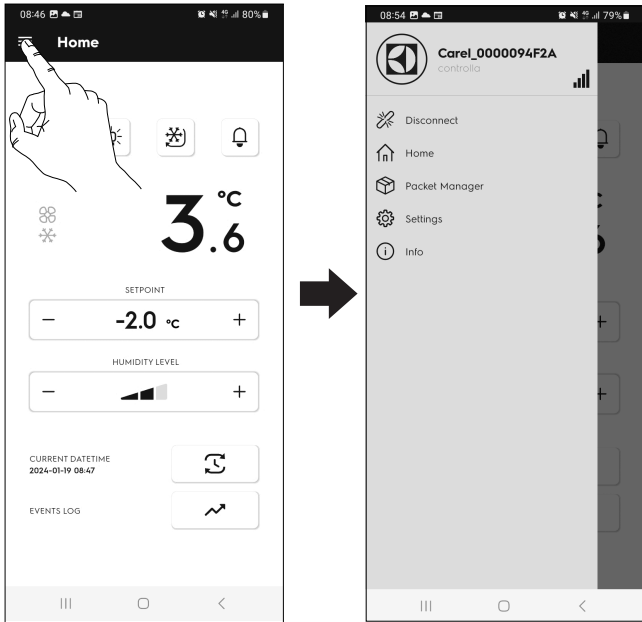

- **Packet Manager**
It allows to visualise appliance display software

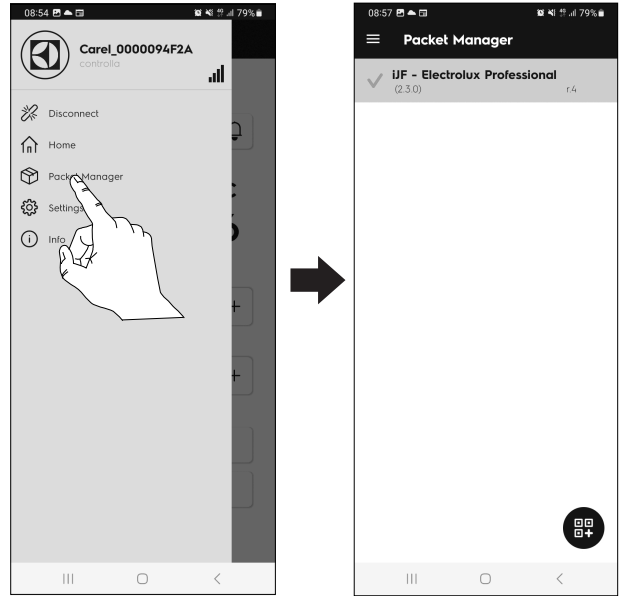

- **Disconnect**
It allows to disconnect the application from the appliance

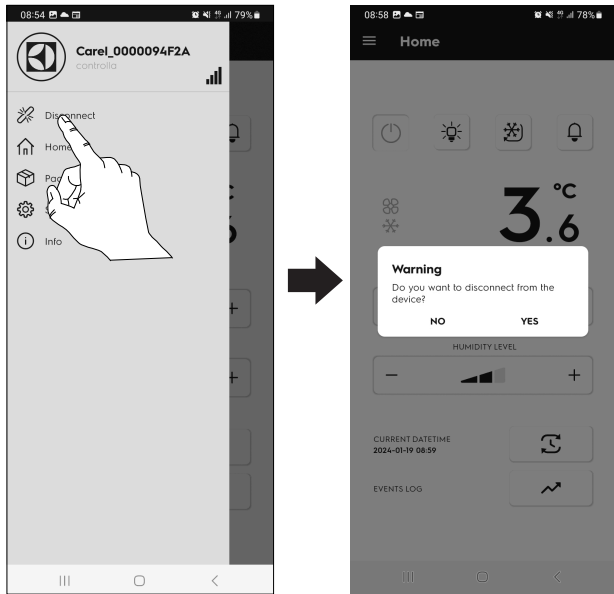

- **Home**
It allows to return to Starting page

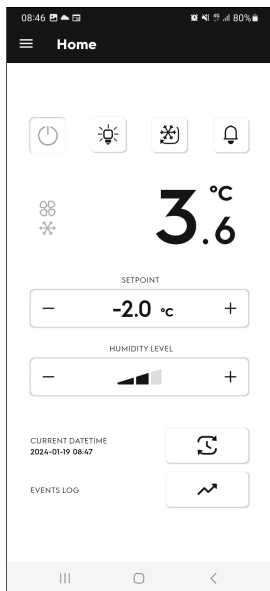

• **Settings**

It allows to change some default app or appliance setting:

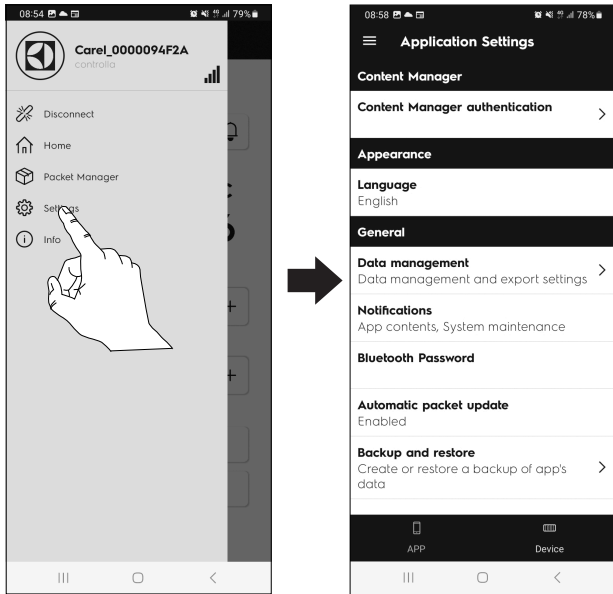

App

- Content Manager authentication
- Language
- Data management
- Notifications
- Bluetooth Password
- Automatic packet update
- Backup and restore

Device (appliance)

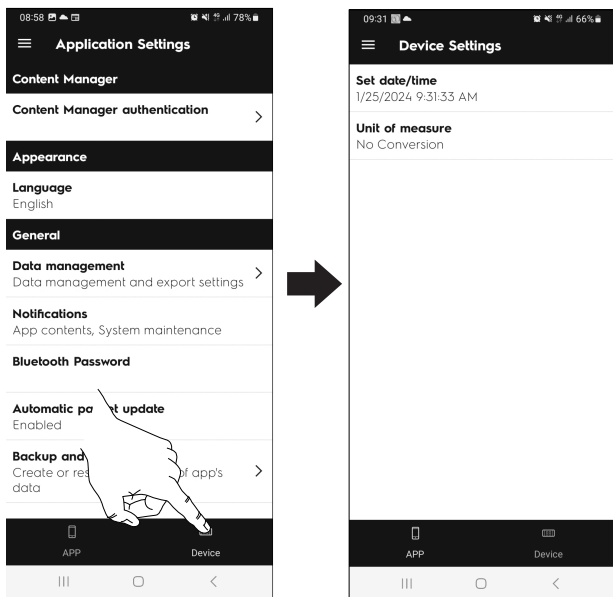

- Set date/time
- Unit of measure

• **Info**

It allows to visualise information about app and appliance.

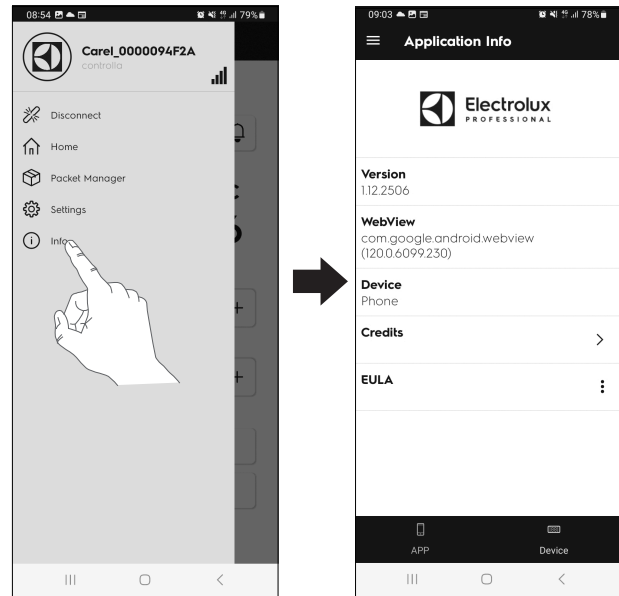

Device (appliance)

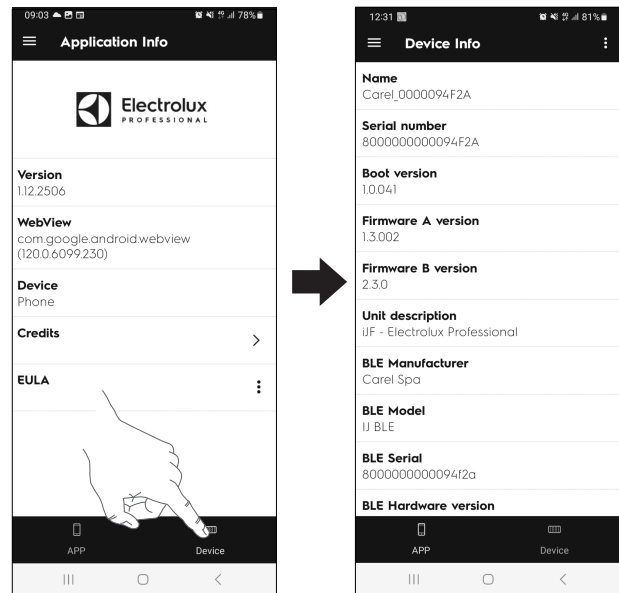



H.3 Main buttons

	It allows to switch on/off the display	green	It indicates that the display is on.
		grey	It indicates that the display is off.
	It allows to switch on/off the appliance internal light ¹	grey	It indicates internal light off.
		yellow	It indicates internal light on.
	It allows to activate/deactivate continuous cycle	green	It indicates continuous cycle activation.
	It allows to see appliance live alarms and history alarms (see H.9 Alarms paragraph)	grey	It indicates that there are no alarms in progress.
		red	It indicates that there are active alarms .

1. if present

H.4 Signalling icons

	yellow	This icon indicates compressor activation.
	yellow	This icon indicates activation of compartment fans.

H.5 Temperature setpoint

It is possible to change the temperature set up.

1. Touch the row of the temperature value;
2. Select the required temperature on the numeric keypad;
3. Confirm.

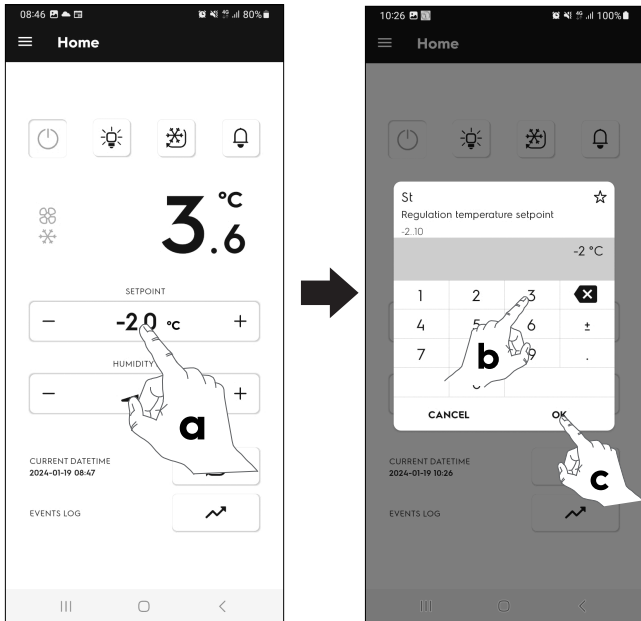

H.7 Device daytime button

It allows to set the mobile's date/time to the appliance.

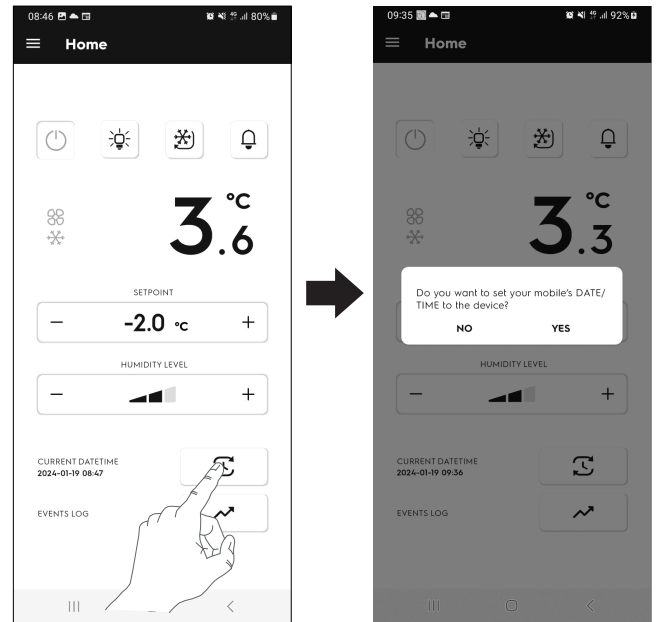

H.6 Humidity setpoint level

(refrigerated models only)

It allows to set 3 different humidity levels.

Touch + or – on the row of the humidity value to select the required level.

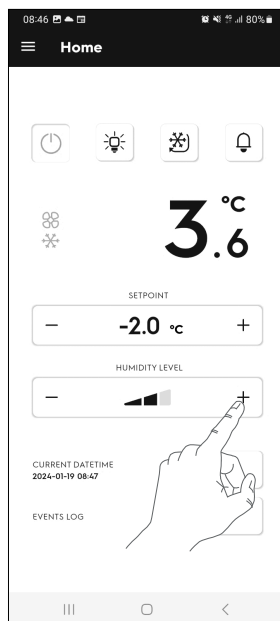

H.8 Event Log button

It allows to view and download all logged appliance data.

H.8.1 Log (data in progress)

Touch on  to view data in progress:

- Temperature data

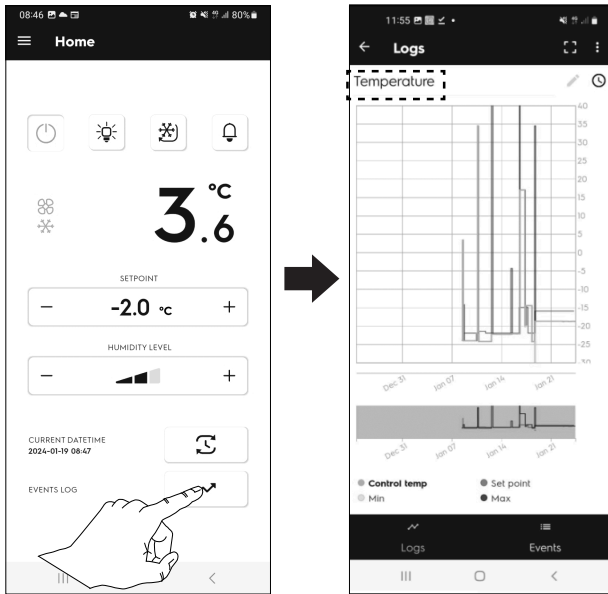

The graphic shows data about temperature, min or max and set point.

- Touch on  Set point to view on the graph for example only set point;

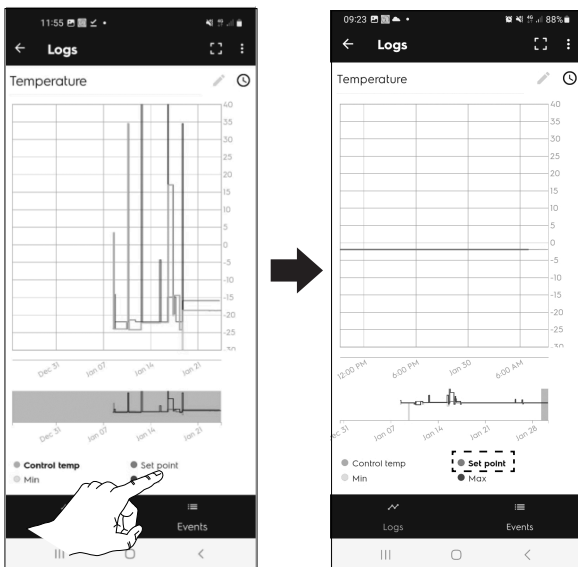

- Touch on  to change graphic view;

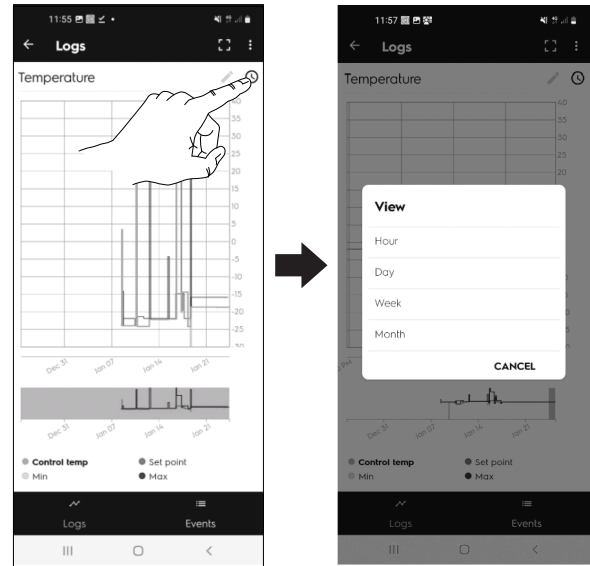

- To zoom in on the graph spread two fingers apart or pinch on the screen;

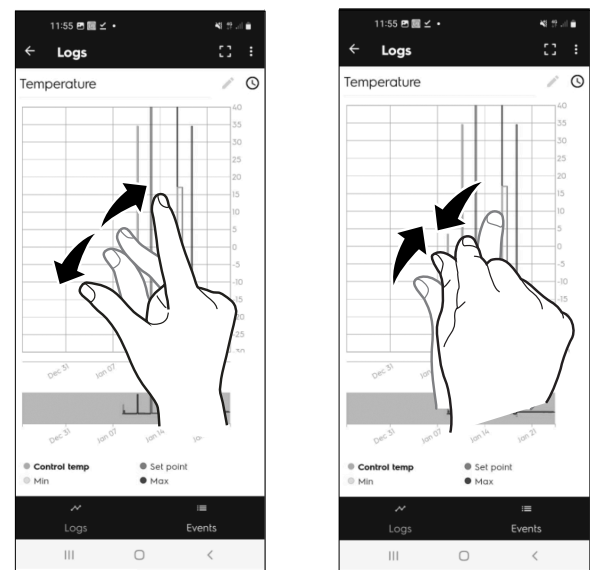

Touch on "Temperature" to view the list of all data in progress

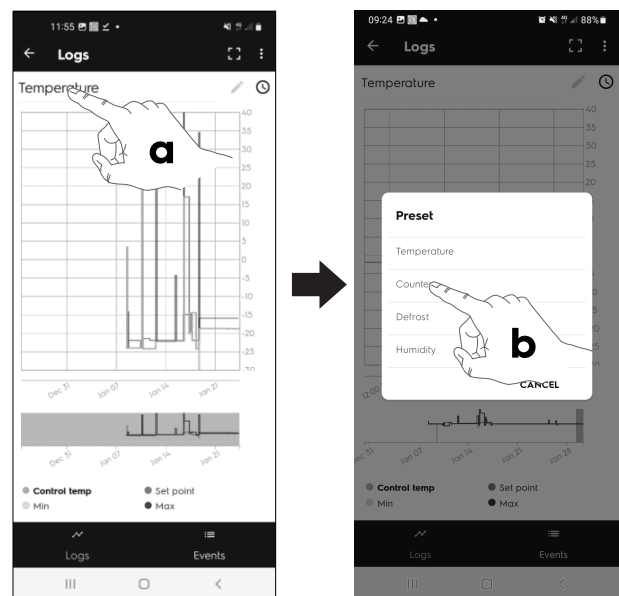

- Counters data
- Defrost data
- Humidity data

To download for example temperature data in progress touch

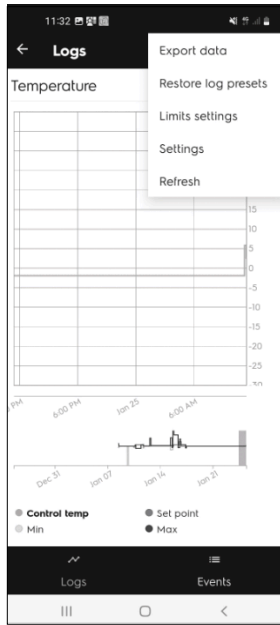

The display shows a pop up with various options:

- export data
- restore log presets
- limits setting
- settings
- refresh

1. Select export data;
2. Set the required options (name and type of file to export – mail address etc);
3. Export file;

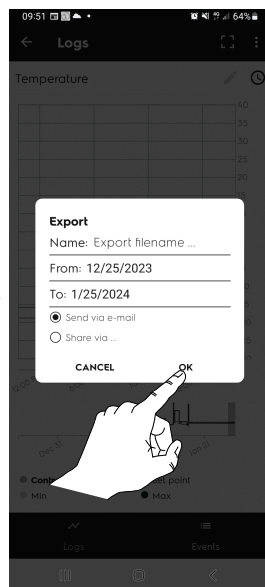
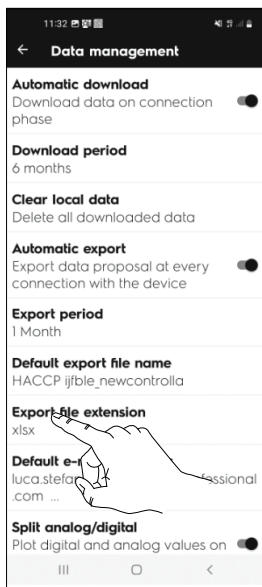

H.8.2 Events (history data view)

Touch on to view history data:

- List of occurred alarms

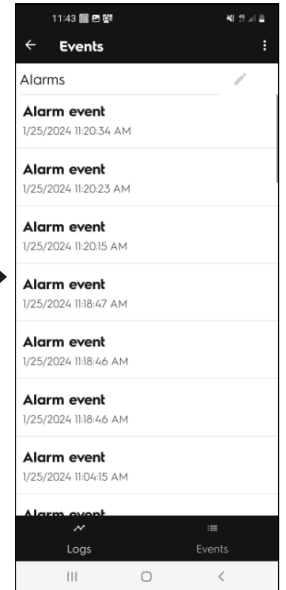
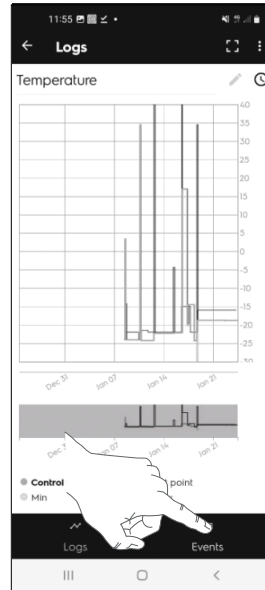

Touch on "Alarms" to view the others history data

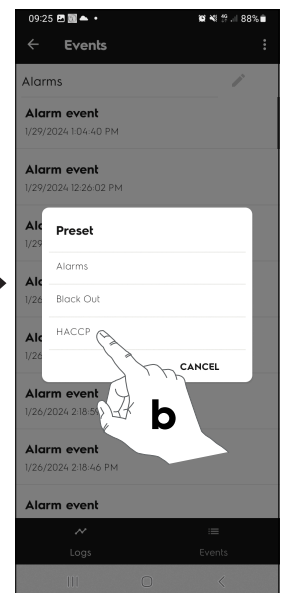
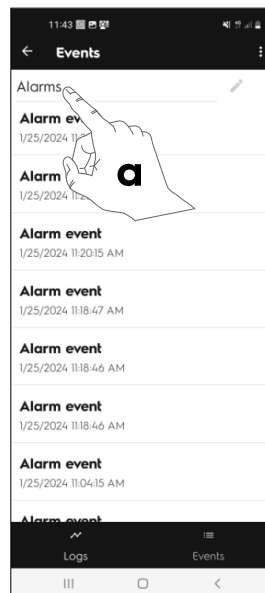

- Black out
- HACCP

To download data touch

The display shows a pop up with various options:

- export events
- restore events presets
- settings
- refresh

1. Select export data;
2. Set the required options (name and type of file to export – mail address etc);

3. Export file;

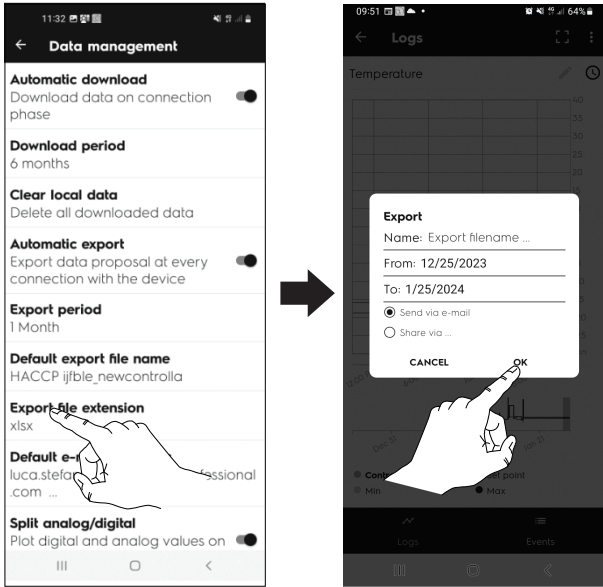

4. Export file;

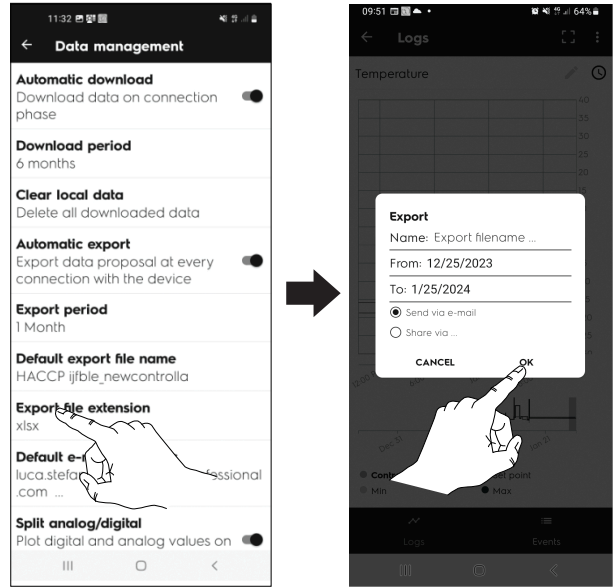

DOWNLOAD HACCP data

1. Open HACCP screen and touch ;

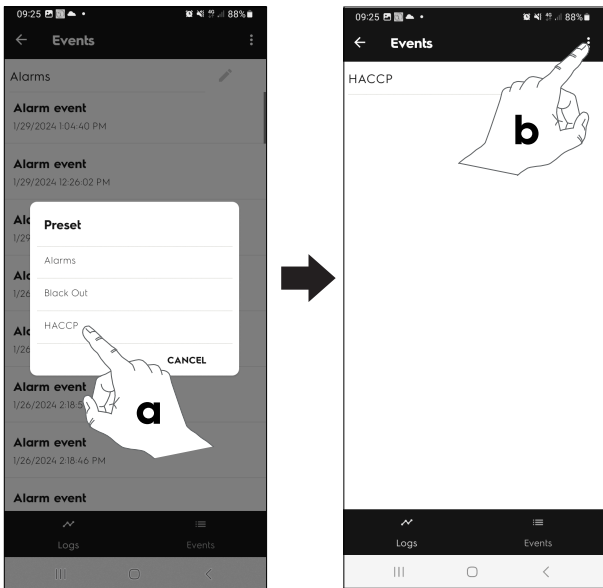

2. Select Settings;

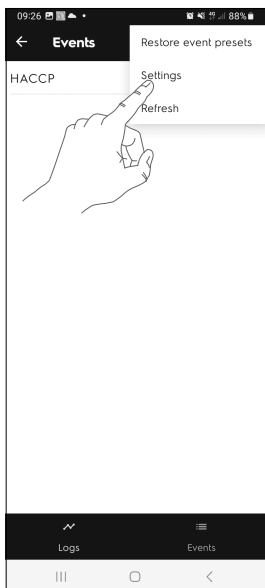

3. Set the required options (name and type of file to export – mail address etc);

H.9 Alarms

When alarm icon is red, it indicates that there are alarms in progress.

Touch  to visualise active alarms.

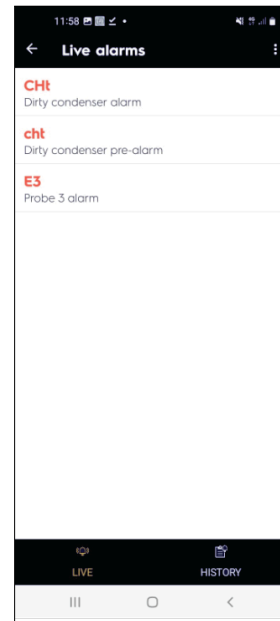

Touch on History icon to view the list of history alarms.

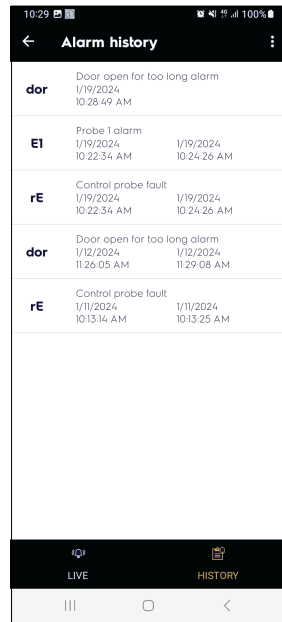
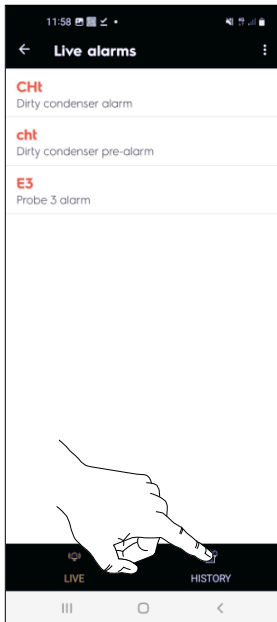

For the complete list of possible alarms see J.2 *Trouble-shooting* chapter.

I MACHINE CLEANING AND MAINTENANCE



WARNING

Refer to “*Warning and Safety Information*”.

I.1 Ordinary maintenance

I.1.1 Care information

Care operations have to be carried out by the owner and/or user of the appliance.



IMPORTANT

Problems resulting from poor or lack of care as hereinafter described will not be covered by the warranty.

I.1.2 Cleaning introduction

For detailed information regarding appliance cleaning refer to paragraph A.11 *Cleaning the cabinet and accessories*.

I.1.3 Compartment cleaning

The racks can be removed in order to thoroughly clean the compartment, therefore remove them before cleaning. For this, use products that are over 90% biodegradable (do not use solvents or abrasive powders), then rinse and dry thoroughly. Lastly, remove the plug closing the drain hole (refrigerated models only) and drain the water (only if it is connected, see paragraph Plumbing connection in the complete installation manual on the web-site).



CAUTION

There is an extra rack on the bottom of the compartment. When cleaning, if this rack is temporarily removed, remember to refit it in its original place, as shown in the figure (detail “c”), in order to ensure proper operation of the appliance:

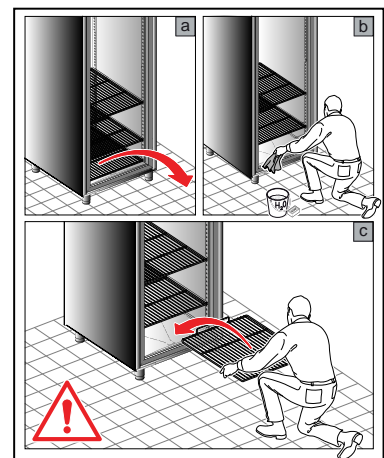

I.1.4 Periods of non-use

If the appliance is not going to be used for some time, take the following precautions:

- disconnect the power supply or remove the plug from the power socket, if present;
- carefully clean the internal parts of the appliance;
- remove all food from the compartment and clean the inside and accessories;
- clean the cabinet, going over all the stainless steel surfaces vigorously with a rag moistened with paraffin oil to create a protective film;
- leave the door or drawers, if present, open so that air can circulate inside, preventing the formation of unpleasant odours;
- periodically air the premises.

J TROUBLESHOOTING

J.1 Introduction

Certain faults may occur during normal use of the appliance. In some cases, faults can be eliminated easily and quickly by following the indication below.

The display, if present, always shows a warning message or alarm describing the occurring fault.

If the fault persists, contact the Customer Care Service:

1. Disconnect the appliance from the main power supply;
2. Switch off the safety circuit breaker ahead of the appliance;
3. Remember to specify:

- the type of fault
- the appliance PNC (product number code)
- the Ser. No. (appliance serial number).



IMPORTANT

The appliance PNC and serial number are essential for identifying the type of appliance and date of manufacture.

The dataplate giving the product and technical data is located inside the appliance. The plate giving the appliance PNC code and serial number is located in the unit compartment.

J.2 Troubleshooting

ANOMALY	TYPE OF ANOMALY	DESCRIPTION	POSSIBLE CAUSES	ACTIONS
E0 rE	ALARM	Compartment sensor fault	<ul style="list-style-type: none"> • Connector unplugged; • Probe and/or Probe wire damaged. 	CALL SERVICE
E1	ALARM	Evaporator sensor fault	<ul style="list-style-type: none"> • Connector unplugged; • Probe and/or Probe wire damaged. 	CALL SERVICE
E2	ALARM	Condenser sensor fault	<ul style="list-style-type: none"> • Connector unplugged; • Probe and/or Probe wire damaged. 	CALL SERVICE
CLN	ALARM	Condenser cleaning alarm	<ul style="list-style-type: none"> • Position of condenser probe is not correct; • Fan condenser not working; • The condenser is dirt or the grid has tapped holes; • The unit cannot dissipate heat because of its positioning. 	<ul style="list-style-type: none"> • Use a vacuum cleaner and remove any dust/dirt from the condenser inlet-air grid. • If the alarm persists Call Service.
Ser	ALARM	Condenser high temperature	<ul style="list-style-type: none"> • Position of condenser probe is not correct; • Fan condenser not working; • The condenser is dirt or the grid has tapped holes; • The unit cannot dissipate heat because of its positioning. 	<ul style="list-style-type: none"> • Use a vacuum cleaner and remove any dust/dirt from the condenser inlet-air grid. • If the alarm persists Call Service.
CN	ALARM	Communication error between controller and LED lamp	<ul style="list-style-type: none"> • Internal error disconnected; • Electronic boards; • Electronic board failure. 	<ul style="list-style-type: none"> • The appliance will continue working with reduced functionality (door opening cannot be detected); • Try to switch the unit OFF/ On; • If the problem persists, Call Service.
The appliance does not switch on.	— — — —	— — — —	<ul style="list-style-type: none"> • Electric supply issue 	<ul style="list-style-type: none"> • Make sure the plug is properly inserted in power socket. • Make sure the socket is powered. • check (if present) the suitability of the fuse on the plug; otherwise contact the assistance service to replace the fuse, which must have the same characteristics as the one being replaced. • If the problem persists Call Service.

<p>The inside temperature is too high.</p>	<p>— — — — —</p>	<p>— — — — —</p>	<ul style="list-style-type: none"> • Door left open • Issue with thermostat setting • Excessive load • Heat source near the appliance 	<ul style="list-style-type: none"> • Make sure the doors close properly. • Check the thermostat setting. • Make sure there is no heat source near the appliance. • Make sure the product is correctly loaded. • If the problem persists Call Service.
<p>The appliance is too noisy.</p>	<p>— — — — —</p>	<p>— — — — —</p>	<ul style="list-style-type: none"> • Unit unlevelled or touching other equipment 	<ul style="list-style-type: none"> • Make sure the appliance is properly levelled. An unbalanced position can set off vibrations. • Make sure the appliance is not touching other equipment or parts which could reverberate. • If the problem persists Call Service.

CE