



Range Overview

SkyLine accessories





Contents

Cooking solutions	6
GastroNorm trays	6
Bakery / Pastry trays	12
Chicken system	14
Smoker	16
Food Probe	17
Handling solutions	18
GastroNorm handling	21
Banqueting handling	23
Bakery / Pastry handling	27
Bakery / Pastry fixed racks	28
Multipurpose fixed racks	28
GastroNorm fixed racks	28
Cleaning solutions	29
Cleaning solutions	29
Water treatment	31
Installation solutions	32
Bases	32
Ventilation	36
Stacking kits	42
Miscellaneous	45
Chilling solutions	49
Food Probe	50
Handling	51
Remote units	51
Installation	52
Connectivity	53



Accessories
compatible with
SkyLine Blast
Chiller/Freezers



Accessories
compatible with
SkyLine Ovens

SkyLine Ovens



6GN 1/1
External dimensions (wxdxh)
867x775x808 mm



6GN 2/1
External dimensions (wxdxh)
1090x971x808 mm



10GN 1/1
External dimensions (wxdxh)
867x775x1058 mm



10GN 2/1
External dimensions (wxdxh)
1090x971x1058 mm



20GN 1/1
External dimensions (wxdxh)
911x865x1794 mm



20GN 2/1
External dimensions (wxdxh)
1162x1067x1794 mm



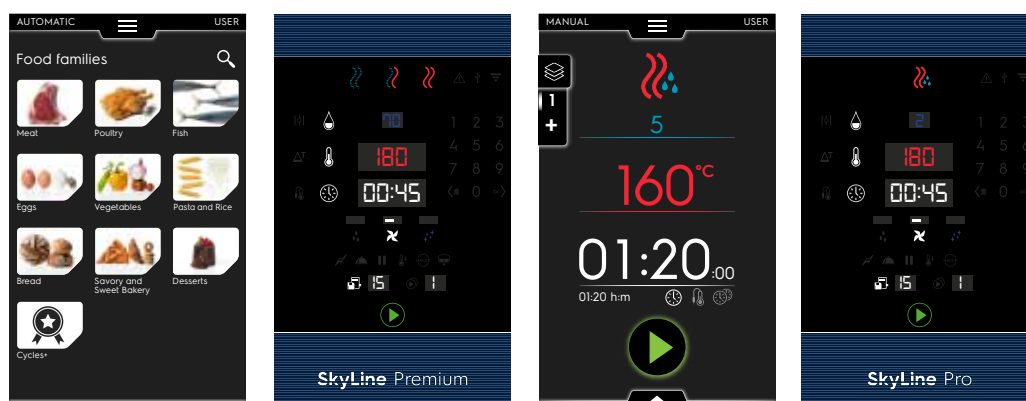

Features	Premium ^S	Premium	Pro ^S	Pro
Control panel	Touch	Digital	Touch	Digital
Steam generation	Boiler-generated steam	Boiler-generated steam	Instant steam generation	Instant steam generation
Humidity control	101 humidity settings controlled with Lambda Sensor	11 humidity settings controlled with Lambda Sensor	11 humidity levels	11 humidity levels
Food probe	6-sensor food probe	Single sensor probe	Single sensor probe	Single sensor probe
Air circulation system	OptiFlow	OptiFlow	OptiFlow	OptiFlow
Fan speed levels	7	5	7	5
Automatic mode	Automatic programs + 11 special cooking Cycles+	n/a	n/a	n/a
Programs mode	Up to 1.000 recipes, using up to 16 phases	Up to 100 recipes, using up to 4 phases	Up to 1.000 recipes, using up to 16 phases	Up to 100 recipes, using up to 4 phases
Automatic cleaning system	SkyClean with Green Functions and automatic boiler descaling	SkyClean with automatic boiler descaling	SkyClean with Green Functions	SkyClean
Integrated spray gun	Yes	Optional	Optional	Optional
Advanced features	Cycles+, Plan-n-Save, SkyHub homepage, MyPlanner, Make-it-Mine, MultiTimer	LED backlight buttons with guided selection	Plan-n-Save, SkyHub homepage, MyPlanner, Make-it-Mine, MultiTimer	LED backlight buttons with guided selection
OnE Connectivity	Optional*	Optional*	Optional*	Optional*
SkyDuo	Yes	n/a	Yes	n/a

* A limited range of standard codes OnE Connectivity ready is also available

GastroNorm trays

Cooking solutions

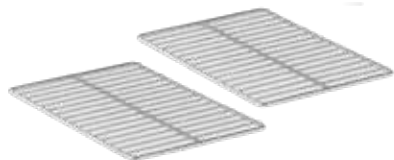

Grids

Size	GN 1/1	GN 2/1
PNC	922017 (pair) 922062 (single)	922175 (pair) 922076 (single)
Material	AISI 304	

- ▶ Ideal:
 - for roasting large pieces
 - as support for irregular containers and plates to be regenerated



Meat hook

Oven size	all
PNC	922348
Hook length	300 mm
Material	AISI 304

- ▶ for peking duck or other large pieces of meat
- ▶ maximum weight: 15 kg
- ▶ hook to be hanged on grid tray (922062 or 922076) placed on the top position of the tray rack

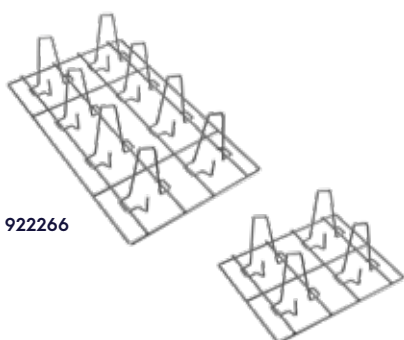

Chicken grids

Size	GN 1/2				GN 1/1	
PNC	922086 (single)				922036 (pair) 922266 (single)	
Chickens per grid	4 (0,7-2 kg size)				8 (0,7-2 kg size)	
Chicken load	16 on 6 GN1/1	32 on 6 GN2/1	24 on 10 GN1/1	48 on 10 GN2/1	48 on 20 GN1/1	96 on 20 GN2/1
Material	AISI 304					

- ▶ Ideal for obtaining perfect browning and juicy cooking results thanks to the distribution of the chickens in the grid

GastroNorm trays

Cooking solutions

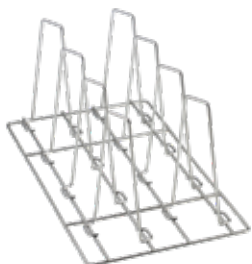

Duck grid

Size	GN 1/1					
PNC	922362					
Ducks per grid	8 (1,2-2,5 kg size)					
Duck load	8 on 6 GN1/1	16 on 6 GN2/1	16 on 10 GN1/1	32 on 10 GN2/1	32 on 20 GN1/1	64 on 20 GN2/1
Material	AISI 304					

- ▶ Ideal for obtaining perfect browning and juicy cooking results thanks to the distribution of the ducks in the grid



Grease collection trays with drain lock

Oven size	GN 1/1	GN 2/1
PNC 40mm	922329	
PNC 60 mm		922357
PNC 100 mm	922321	
Material	AISI 304	

- ▶ Ideal for an easy fat collection and drainage thanks to the integrated stainless steel drain
- ▶ Include tray with integrated drain and lid

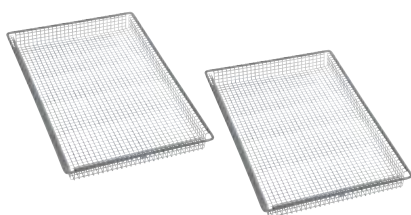

Cooking baskets

Size	GN 1/1
PNC	922239 (pair)
Material	AISI 304

- ▶ Ideal for
 - steaming
 - air frying frozen pre-fried food (french fries, chicken nuggets, crab sticks, etc.)

GastroNorm trays

Cooking solutions



Non-stick U-pans with coating

Size	GN 1/2	GN 1/1
PNC 20 mm	925009	925000 (single) 925012 (6 pcs)
PNC 40 mm	925010	925001 (single) 925013 (6 pcs)
PNC 60 mm	925011	925002 (single) 925014 (6 pcs)
Material	aluminum alloy with non-stick coating	

- ▶ Ideal for:
 - reducing cooking time up to 10% and energy consumption up to 8% (surface preheating is not required; differently from fry tops, the pan can come directly from the refrigerator)
 - reducing food weight loss by 2-4% in comparison with traditional methods, enabling juicier products
 - improving operations (eliminates smoke, heat, necessity to grease the pans and turn food upside down)
- ▶ Recommended to use plastic spatulas in order to extend special coating life
- ▶ Recommended not to clean with granule-type dishwashers

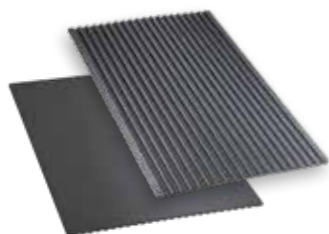

Double face griddle (ribbed and smooth)

Size	GN 1/1
PNC	925003
Material	aluminum alloy with non-stick coating

- ▶ Ideal for:
 - various cooking needs (double-faced pan features ribbed side for grilling and marking, flat side for baking and toasting)
 - improving operations (no pre-heating needed, eliminates smoke and heat exhaustion, aluminum enhances the heat exchange for faster and more even cooking)
 - baking on smooth side



Non-stick grill with coating

Size	GN 1/1
PNC	925004
Material	aluminum alloy with non-stick coating

- ▶ Ideal for:
 - marking steaks
 - improving operations (no pre-heating needed)
 - low fat cooking

GastroNorm trays

Cooking solutions



Mesh grilling grid

Size	GN 1/1
PNC	922713
Material	aluminum alloy with non-stick coating

- ▶ Ideal for:
 - marking steaks
 - improving operations (no preheating needed)
 - low fat cooking



Tray for traditional static cooking

Size	GN 1/1
PNC	922746
Height	100 mm
Material	aluminum alloy with non-stick coating

- ▶ Ideal for:
 - braising stewed meat
 - long cooking sauces (like ragù)



Non-stick egg fryer with coating

Size	GN 1/1
PNC	925005
Material	aluminum alloy with non-stick coating

- ▶ Ideal for:
 - egg automatic cooking program; may be used also for pancakes, hamburgers, omelettes, quiches and other round shaped food
 - improving operations (no preheating needed, aluminum enhances the heat exchange for faster and more even cooking)

GastroNorm trays

Cooking solutions



Flat baking tray

Size	GN 1/1
PNC	925006
Material	aluminum alloy with non-stick coating

- ▶ Ideal for:
 - baking bread and pastry



Non-stick perforated U-pans with coating

Size	GN 1/1
PNC 20 mm	922651
PNC flat	922652
Material	aluminum alloy with non-stick coating

- ▶ Ideal for:
 - dehydrate fruits and vegetables without need of using baking paper
 - baking



Non-stick baguette tray with coating

Size	GN 1/1
PNC	925007
Material	perforated aluminum, silicon coating

- ▶ Ideal for:
 - baking baguettes (enables fitting 4 pieces, 290 g each)
 - improving operations (perforated aluminum enhances the heat exchange for faster and more even cooking)

GastroNorm trays

Cooking solutions

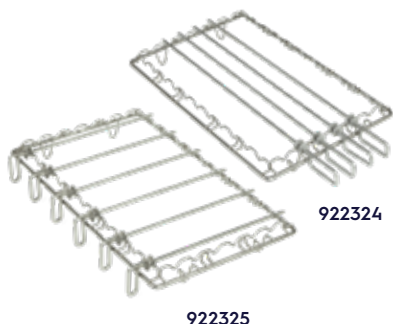

Universal skewer racks

Size	GN 1/1	GN 2/1
PNC 20 mm	922324 (1 rack + 4 long skewers)	922325 (1 rack + 6 short skewers)
PNC Long skewer	922327 (x4)	
PNC Short skewer		922328 (x6)
PNC Rack	922326	
Material	AISI 304	

- ▶ Ideal for preparing all type of kebab, tandoor grill, churrasco, yakitori and any other kind of cooking using skewers (from meat to poultry, to fish, to vegetables and cheese)



Spit for lamb or suckling pig

Oven size	10 GN 1/1
PNC	922709
Capacity	up to 12 kg
Dimension WxDxH	158x264x600 mm
Material	AISI 304

- ▶ Ideal for:
 - cooking entire sizes of meat using skewer such as kebab, pork, lamb, mutton, porchetta
- ▶ Spit to be fixed on grid tray (922062) placed on the bottom position of the tray rack

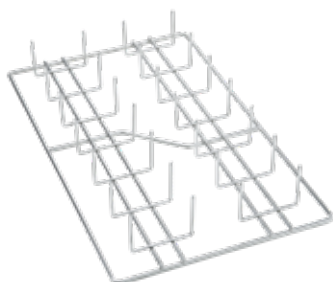

Potato baker

Size	GN 1/1					
PNC	925008					
Potatoes per grid	28					
Potato load	84 6 GN1/1	168 6 GN2/1	140 10 GN1/1	280 10 GN2/1	224 20 GN1/1	448 20 GN2/1
Material	AISI 304					

Bakery / Pastry trays

Cooking solutions



Grid

Size	400 x 600 mm
PNC	922264*
Material	AISI 304

- ▶ Ideal
 - as a support for 1/1 GN containers without having to replace the tray rack from Bakery to 1/1 GN
 - for cooking with irregularly shaped containers



Baguette tray

Size	400 x 600 mm
PNC	922189*
Material	perforated aluminum, silicon coated

- ▶ Ideal for
 - baking baguettes (enables fitting 5 pieces, max. 600 mm long)
 - improving operations (perforated aluminum enhances the heat exchange for faster and more even cooking)



Perforated bakery/pastry tray

Size	400 x 600 mm
PNC	922190*
Material	perforated aluminum

- ▶ Ideal for
 - baking light pastry
 - improving operations (perforated aluminum enhances the heat exchange for faster and more even cooking)



Smooth bakery/pastry tray

Size	400 x 600 mm
PNC	922191*
Material	aluminum

- ▶ Ideal for:
 - baking breads and pastry
 - improving operations (perforated aluminum enhances the heat exchange for faster and more even cooking)

* Requires bakery/pastry racks 400 x 600 mm (see page 28)

Bakery / Pastry trays

Cooking solutions



Double face griddle (ribbed and smooth)

Oven size	400 x 600 mm
PNC	922747*
Material	aluminum alloy with non-stick coating

- ▶ Ideal for:
 - baking on smooth side
 - various cooking needs (double-faced pan features ribbed side for grilling and marking, flat side for baking and toasting)
 - improving operations (no pre-heating needed, eliminates smoke and heat exhaustion, aluminum enhances the heat exchange for faster and more even cooking)

* Requires bakery/pastry racks 400 x 600 mm (see page 28)

Chicken system

Cooking solutions



Reinforced mobile tray rack

Oven size	10 GN 1/1
PNC	922694

- ▶ Ideal for greasy cooking - with 11 tray guides where the lowest one is suitable for a grease drip tray
- ▶ If used with wheels, slide-in (922610) support is required
- ▶ Includes wheels
- ▶ Recommended to be used with grease collection kit (922619 or 922639)



GreaseOut - grease collection kit for oven cupboard base with trolley

Oven size	6 GN 1/1	6 GN 2/1	10 GN 1/1	10 GN 2/1
PNC	922619			

- ▶ Trolley with removable handle
- ▶ Opening tap on top frontal panel
- ▶ Easy connection with oven
- ▶ Holder for handle included
- ▶ 2 wheels with brakes
- ▶ 2 tanks of 10 lt each



GreaseOut - grease collection kit for oven open base

Oven size	6 GN 1/1	6 GN 2/1	10 GN 1/1	10 GN 2/1
PNC	922639			

- ▶ Opening tap on top frontal panel
- ▶ Easy connection with oven
- ▶ 2 tanks of 10 lt each

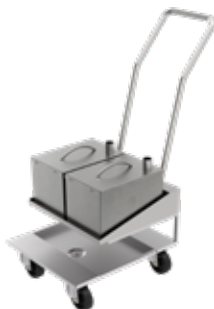

Extra trolley and tanks for grease collection kit

Oven size	6 GN 1/1	6 GN 2/1	10 GN 1/1	10 GN 2/1
PNC tanks + trolley	922638			
PNC trolley	922752			

- ▶ Ideal for both cupboard base and open base
- ▶ Removable handle
- ▶ Holder for handle included
- ▶ 2 wheels with brakes
- ▶ 2 tanks of 10 lt each (included only in 922638)

Grease collection kit for 6 GN 1/1 stacked ovens and 6 GN 2/1 stacked ovens installed on riser: available as special, to be ordered with the oven.

Chicken system

Cooking solutions



Grease collection trays with drain lock

Oven size	GN 1/1	GN 2/1
PNC 40 mm	922329	
PNC 60 mm		922357
PNC 100 mm	922321	
Material	AISI 304	

- ▶ Ideal for an easy fat collection and drainage thanks to the integrated stainless steel drain
- ▶ Include tray with integrated drain and lid

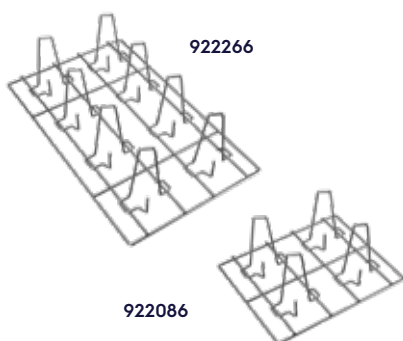

Chicken grids

Size	GN 1/2			GN 1/1		
PNC	922086 (single)			922036 (pair) 922266 (single)		
Chickens per grid	4 (0,7-2 kg size)			8 (0,7-2 kg size)		
Chicken load	16 on 6 GN1/1	32 on 6 GN2/1	24 on 10 GN1/1	48 on 10 GN2/1	48 on 20 GN1/1	96 on 20 GN2/1
Material	AISI 304					

- ▶ Ideal for obtaining perfect browning and juicy cooking results thanks to the distribution of the chickens in the grid

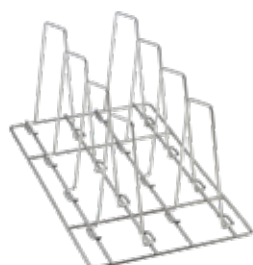

Duck grid

Size	GN 1/1					
PNC	922362					
Ducks per grid	8 (1,2-2,5 kg size)					
Duck load	8 on 6 GN1/1	16 on 6 GN2/1	16 on 10 GN1/1	32 on 10 GN2/1	32 on 20 GN1/1	64 on 20 GN2/1
Material	AISI 304					

- ▶ Ideal for obtaining perfect browning and juicy cooking results thanks to the distribution of the ducks in the grid

Smoker

Cooking solutions



Volcano smoker

Oven size	6 GN 1/1	6 GN 2/1	10 GN 1/1	10 GN 2/1	20 GN 1/1	20 GN 2/1
PNC	922338					
Material	AISI 304					
Dimension WxDxH	220 X 220 X 85 mm					

- ▶ Ideal for:
 - cooking and smoking of fish, pork, poultry, beef, cheese, bread, vegetables (using wood pellets, dried spices)
 - low temperature cooking with smoked flavour
- ▶ The quantity of smoke produced can be adjusted (registered design @ EPO)
- ▶ Odourless and Condensation hoods are not suitable to be used with Volcano smoker because there is no direct connection to the external exhaust
- ▶ To be used with charcoal



Wood pellets to be used with Volcano smoker

Code	0S2602	0S2603	0S2604	0S2605	0S2606
Flavor	mesquite	hickory	sugar maple	cherry	apple
Weight	450 g				

- ▶ Mesquite: ideal for ribs, red meat, pork, fish and heavy game
- ▶ Hickory: sweet to strong, heavy bacon flavour. Ideal for pork, ham and beef
- ▶ Sugar maple: smoky, mellow and slightly sweet. Ideal for pork, poultry, cheese, and small game birds
- ▶ Cherry: ideal for poultry, pork and beef
- ▶ Apple: ideal for beef, pork, poultry, fish and game

Food Probe

Cooking solutions



USB single point probe

Oven size	6 GN 1/1	6 GN 2/1	10 GN 1/1	10 GN 2/1	20 GN 1/1	20 GN 2/1
PNC	922390					

- ▶ To be used in addition to the standard core temperature probe
- ▶ Suitable also for high temperature cooking



USB sous-vide probe

Oven size	6 GN 1/1	6 GN 2/1	10 GN 1/1	10 GN 2/1	20 GN 1/1	20 GN 2/1
PNC	922281					

- ▶ Ideal for sous-vide low temperature cooking to ensure that the correct core temperature is accurately reached without affecting the vacuum in the bag
- ▶ 1 mm in diameter, 60 mm in length, with a special diagonal-cut needle point design to avoid breaking the vacuum seal when inserted
- ▶ To be used with neoprene adhesive strips (code OS1827*) or valve (code OS2788*) and vacuum cooking bags (OS2473*) to avoid breaking the vacuum seal when inserted



Valve for sous-vide probe

Oven size	6 GN 1/1	6 GN 2/1	10 GN 1/1	10 GN 2/1	20 GN 1/1	20 GN 2/1
PNC	OS2788					

- ▶ It creates a barrier against air, where the probe needle pierces the bag, thus allowing safe detection of the core temperature of vacuum cooked food
- ▶ Suitable for use in cooking and blast chilling processes from -20°C to 130°C
- ▶ Suitable for cooking processes in a bain-marie up to 100°C and in a steam oven up to 130°C

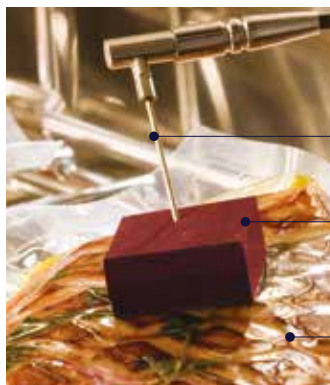

Sous-vide cooking, what you need:

- USB Sous-vide probe
- Neoprene adhesive strips or valve for sous-vide probe
- Vacuum bags (different sizes)

* More accessories for sous-vide cooking are available in the Accessories & Consumables Catalogue





Handling solutions

Handling solutions - GastroNorm

Oven & Blast Chiller/ Freezer Size	6 GN 1/1	6 GN 2/1	10 GN 1/1	10 GN 2/1	20 GN 1/1	20 GN 2/1
 GastroNorm rack (6-10)* or trolley rack (20)*	922600 65 mm pitch	922700 65 mm pitch	922601 65 mm pitch	922603 65 mm pitch	922753 63 mm pitch	922757 63 mm pitch
	922606 80 mm pitch	922611 80 mm pitch	922602 80 mm pitch	922604 80 mm pitch	922754 80 mm pitch	922758 80 mm pitch
					922683 84 mm pitch	922686 84 mm pitch
 Slide-in support (+ handle) ONLY FOR OVENS	922610	922605	922610	922605	not necessary	not necessary
 Slide-in support (+ handle) ONLY FOR BLAST CHILLER/ FREEZERS	not available	not available	880564	880563	not necessary	not necessary
 Trolley	922626	922627	922626	922627	not necessary	not necessary

* Every rack includes wheels





Handling solutions - Banqueting

Oven & Blast Chiller/ Freezer Size	6 GN 1/1	6 GN 2/1	10 GN 1/1	10 GN 2/1	20 GN 1/1	20 GN 2/1
 Banqueting rack (6-10)* or trolley rack (20)	not available	not available	922648 30 plates, 65 mm pitch	922650 51 plates, 75 mm pitch	922756 54 plates, 74 mm pitch	922760 92 plates, 85 mm pitch
			922649 23 plates, 85 mm pitch		922763 45 plates, 90 mm pitch	922764 116 plates, 66 mm pitch
 Slide-in support (+ handle) ONLY FOR OVENS	not available	not available	922610	922605	not necessary	not necessary
 Slide-in support (+ handle) ONLY FOR BLAST CHILLER/ FREEZERS	not available	not available	880564	880563	not necessary	not necessary
 Trolley	not available	not available	922626	922627	not necessary	not necessary
 Thermal blanket	not available	not available	922364	922366	922365	922367



* Every rack includes wheels

Handling solutions

Handling solutions - Bakery/Pastry

Oven & Blast Chiller/ Freezer Size	6 GN 1/1	6 GN 2/1	10 GN 1/1	10 GN 2/1	20 GN 1/1	20 GN 2/1
 Mobile 400x600 mm Bakery/Pastry rack (6-10)*/** or Trolley rack (20)	922607 5 grids, 80 mm pitch	not available	922608 8 grids, 80 mm pitch	922609 8 grids, 80 mm pitch	922761 16 grids, 80 mm pitch	922762 16 grids, 80 mm pitch
 Slide-in support (+ handle) ONLY FOR OVENS	922610	not available	922610	922605	not necessary	not necessary
 Slide-in support (+ handle) ONLY FOR BLAST CHILLER/FREEZERS	not available	not available	880564	880563	not necessary	not necessary
 Trolley	922626	not available	922626	922627	not necessary	not necessary

Handling solutions - Stacking ovens

Stacked Ovens Size	6 GN 1/1 on 6 GN 1/1	6 GN 2/1 on 6 GN 2/1	6 GN 1/1 on 10 GN 1/1	6 GN 2/1 on 10 GN 2/1
 Mobile racks (6-10): - GastroNorm* - 400x600 mm Bakery/Pastry*/** - Banqueting* For each oven select one type of rack among the ones listed	TOP OVEN 922600 (GN) 65 mm pitch 922606 (GN) 5 grids, 80 mm pitch 922607 (400x600 mm) 5 grids, 80 mm pitch BOTTOM OVEN 922600 (GN) 65 mm pitch 922606 (GN) 5 grids, 80 mm pitch 922607 (400x600 mm) 5 grids, 80 mm pitch	TOP OVEN 922700 (GN) 65 mm pitch 922611 (GN) 5 grids, 80 mm pitch BOTTOM OVEN 922700 (GN) 65 mm pitch 922611 (GN) 5 grids, 80 mm pitch	TOP OVEN 922600 (GN) 65 mm pitch 922606 (GN) 5 grids, 80 mm pitch 922607 (400x600 mm) 5 grids, 80 mm pitch BOTTOM OVEN 922601 (GN) 65 mm pitch 922602 (GN) 8 grids, 80 mm pitch 922608 (400x600 mm) 8 grids, 80 mm pitch 922648 (30 plates) 65 mm pitch 922649 (23 plates) 85 mm pitch	TOP OVEN 922700 (GN) 65 mm pitch 922611 (GN) 5 grids, 80 mm pitch BOTTOM OVEN 922603 (GN) 65 mm pitch 922604 (GN) 8 grids, 80 mm pitch 922609 (400x600 mm) 8 grids, 80 mm pitch 922650 (51 plates) 75 mm pitch
 Slide-in support (+ handle)	2 pcs x 922610	2 pcs x 922605	2 pcs x 922610	2 pcs x 922605
 Trolley	922630 or 922628 (On Riser)	922631 or 922629 (On Riser)	922630	922631

* Every rack includes wheels

** When converting to Bakery/Pastry version (400x600 mm) a specific suction wall is suggested. Electrolux Professional recommends to install the correct suction wall in order to guarantee optimal cooking evenness. Suction wall can be purchased at Electrolux Professional Authorized Service Partners.

Handling solutions

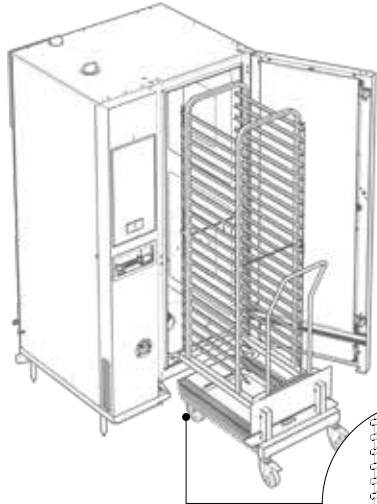

Kit compatibility for air-o-system trolleys with SkyLine ovens

Oven size	20 GN 1/1	20 GN 2/1
PNC	922769	922770

- ▶ Adaptors to increase the width of the bottom part of the trolleys to perfectly fit in SkyLine ovens
- ▶ Can be installed on GN, Banqueting and Bakery trolleys
- ▶ To be combined with compatibility kit for air-o-system ovens in case of simultaneous use in both SkyLine and air-o-system ovens

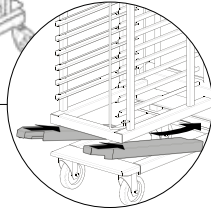

Kit compatibility for air-o-system ovens with SkyLine trolleys

Oven size	20 GN 1/1	20 GN 2/1
PNC	922771	

- ▶ Spacer kit to expand the roll-in rails placed at the bottom of the air-o-system ovens
- ▶ Can accommodate GN, Banqueting and Bakery trolleys
- ▶ To be combined with compatibility kit for air-o-system trolleys in case of simultaneous use of both SkyLine and air-o-system trolleys
- ▶ Not needed for Blast Chillers

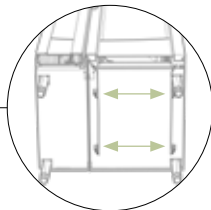

GastroNorm handling

Handling solutions

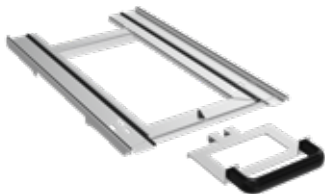

Slide-in supports

Oven size	6 GN 1/1	6 GN 2/1	10 GN 1/1	10 GN 2/1
PNC for oven	922610	922605	922610	922605
PNC for blast chiller			880564	880563

- ▶ Ideal for easy and safe loading and unloading of mobile rack
- ▶ Include handle
- ▶ Required when using mobile rack
- ▶ Slide-in support for **air-o-system oven** to be ordered as a spare part



Trolley for mobile racks

Oven size	6 GN 1/1	6 GN 2/1	10 GN 1/1	10 GN 2/1
PNC	922626	922627	922626	922627
Dimension WxDxH	485x913x949 mm	685x1033x949 mm	485x913x949 mm	685x1033x949 mm

- ▶ Ideal for smooth handling process
- ▶ Recommended to be used with slide-in support
- ▶ Trolley for stacking solution available (see page 43)
- ▶ Compatible with **air-o-system ovens**. Slide-in support for air-o-system oven to be ordered as a spare part



Mobile GastroNorm racks

Oven size	6 GN 1/1	
PNC	922600	922606
Grid nr.	6 grids (65 mm pitch)	5 grids (80 mm pitch)
Dimension WxDxH	389x508x462 mm	

- ▶ Include wheels and base supports
- ▶ If used with wheels, slide-in support is required
- ▶ If used with base support it becomes a fixed rack
- ▶ Compatible with **air-o-system ovens**. Slide-in support for air-o-system oven to be ordered as a spare part

GastroNorm handling

Handling solutions



Mobile GastroNorm racks

Oven size	6 GN 2/1	
PNC	922700	922611
Grid nr.	6 grids (65 mm pitch)	5 grids (80 mm pitch)
Dimension WxDxH	594x628x477 mm	

- ▶ Include wheels and base supports
- ▶ If used with wheels, slide-in support is required
- ▶ If used with base support it becomes a fixed rack
- ▶ Compatible with **air-o-system ovens**. Slide-in support for air-o-system oven to be ordered as a spare part



Mobile GastroNorm racks

Oven size	10 GN 1/1	
PNC	922601	922602
Grid nr.	10 grids (65 mm pitch)	8 grids (80 mm pitch)
Dimension WxDxH	389x508x723,5 mm	

- ▶ Include wheels and base supports
- ▶ If used with wheels, slide-in support is required
- ▶ If used with base support it becomes a fixed rack
- ▶ Compatible with **air-o-system ovens**. Slide-in support for air-o-system oven to be ordered as a spare part



Mobile GastroNorm racks

Oven size	10 GN 2/1	
PNC	922603	922604
Grid nr.	10 grids (65 mm pitch)	8 grids (80 mm pitch)
Dimension WxDxH	594x628x723,5 mm	

- ▶ Include wheels and base supports
- ▶ If used with wheels, slide-in support is required
- ▶ If used with base support it becomes a fixed rack
- ▶ Compatible with **air-o-system ovens**. Slide-in support for air-o-system oven to be ordered as a spare part

GastroNorm handling

Handling solutions



GastroNorm trolleys

Oven size	20 GN 1/1		
PNC	922753	922754	922683
Grid nr.	20 grids (63 mm pitch)	16 grids (80 mm pitch)	15 grids (84 mm pitch)
Dimension WxDxH	545x790x1700 mm		

- ▶ Include: removable handle, base with a drain, rear wheels with brakes
- ▶ Compatible with air-o-system
- ▶ For perfect compatibility with **air-o-system** ovens order PNC 922771 (to be installed on the ovens)

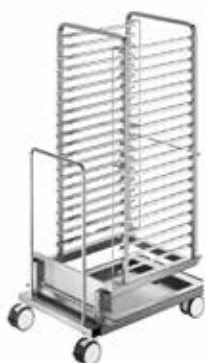

GastroNorm trolleys

Oven size	20 GN 2/1		
PNC	922757	922758	922686
Grid nr.	20 grids (63 mm pitch)	16 grids (80 mm pitch)	15 grids (84 mm pitch)
Dimension WxDxH	716x926x1700 mm		

- ▶ Include: removable handle, base with a drain, rear wheels with brakes
- ▶ Compatible with air-o-system
- ▶ For perfect compatibility with **air-o-system** ovens order PNC 922771 (to be installed on the ovens)

Banqueting handling

Handling solutions

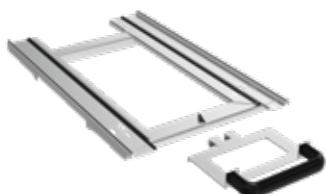

Slide-in supports

Oven size	6 GN 1/1	6 GN 2/1	10 GN 1/1	10 GN 2/1
PNC for oven	922610	922605	922610	922605
PNC for blast chiller			880564	880563

- ▶ Ideal for easy and safe uploading and downloading of mobile rack
- ▶ Include handle
- ▶ Required when using mobile rack
- ▶ Slide-in support for **air-o-system oven** to be ordered as a spare part



Trolleys for mobile racks

Oven size	6 GN 1/1	6 GN 2/1	10 GN 1/1	10 GN 2/1
PNC	922626	922627	922626	922627
Dimension WxDxH	485x913x949 mm	685x1033x949 mm	485x913x949 mm	685x1033x949 mm

- ▶ Ideal for smooth handling process
- ▶ Recommended to be used with slide-in support
- ▶ Trolley for stacking solution available (see page 43)
- ▶ Compatible with **air-o-system ovens**. Slide-in support for air-o-system oven to be ordered as a spare part



Mobile banqueting racks

Oven size	10 GN 1/1	
PNC	922648	922649
Grid nr.	30 plates (65 mm pitch)	23 plates (85 mm pitch)
Dimension WxDxH	391x650x710 mm	

- ▶ Include wheels and base supports
- ▶ Slide-in support is required
- ▶ Plates up to 310 mm Ø
- ▶ Compatible with **air-o-system ovens**. Slide-in support for air-o-system oven to be ordered as a spare part

Banqueting handling

Handling solutions



Mobile banqueting racks

Oven size	10 GN 2/1
PNC	922650
Grid nr.	51 plates (75 mm pitch)
Dimension WxDxH	596x780x702 mm

- ▶ Includes wheels and base supports
- ▶ Slide-in support is required
- ▶ Plates up to 310 mm Ø
- ▶ Compatible with **air-o-system ovens**. Slide-in support for air-o-system oven to be ordered as a spare part



Banqueting trolleys

Oven size	20 GN 1/1	
PNC	922756	922763
Grid nr.	54 plates (74 mm pitch)	45 plates (90 mm pitch)
Dimension WxDxH	507x849x1714 mm	

- ▶ Include: removable handle, base with a drain, rear wheels with brakes
- ▶ Plates up to 310 mm Ø
- ▶ Compatible with **air-o-system ovens**. Slide-in support for air-o-system oven to be ordered as a spare part



Banqueting trolleys

Oven size	20 GN 2/1	
PNC	922760	922764
Grid nr.	92 plates (85 mm pitch)	116 plates (66 mm pitch)
Dimension WxDxH	700x986x1711 mm	

- ▶ Include: removable handle, base with a drain, rear wheels with brakes
- ▶ Plates up to 310 mm Ø
- ▶ Compatible with **air-o-system ovens**. Slide-in support for air-o-system oven to be ordered as a spare part

Banqueting handling

Handling solutions



Thermal blankets for racks

Oven size	10 GN 1/1	10 GN 2/1
PNC	922364	922366

- ▶ Ideal for keeping food warm up to 30 minutes
- ▶ Enable easy folding with straps
- ▶ Washable: ETL Sanitation approved



Thermal blankets for trolleys

Oven size	20 GN 1/1	20 GN 2/1
PNC	922365	922367

- ▶ Ideal for keeping food warm up to 30 minutes
- ▶ Enable easy folding with straps
- ▶ Washable: ETL Sanitation approved

Bakery / Pastry handling

Handling solutions

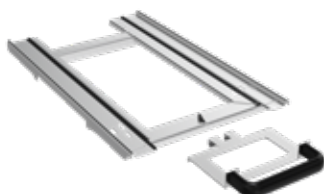

Slide-in supports

Oven size	6 GN 1/1	6 GN 2/1	10 GN 1/1	10 GN 2/1
PNC for oven	922610	922605	922610	922605
PNC for blast chiller			880564	880563

- ▶ Ideal for easy and safe uploading and downloading of mobile rack
- ▶ Include handle
- ▶ Required when using mobile rack
- ▶ Slide-in support for **air-o-system oven** to be ordered as a spare part



Trolleys for mobile racks

Oven size	6 GN 1/1	6 GN 2/1	10 GN 1/1	10 GN 2/1
PNC	922626	922627	922626	922627
Dimension WxDxH	485x913x949 mm	685x1033x949 mm	485x913x949 mm	685x1033x949 mm

- ▶ Ideal for smooth handling process
- ▶ Recommended to be used with slide-in support
- ▶ Trolley for stacking solution available (see page 43)
- ▶ Compatible with **air-o-system ovens**. Slide-in support for air-o-system oven to be ordered as a spare part



Mobile bakery/pastry racks (400x600 mm)*

Oven size	6 GN 1/1	10 GN 1/1	10 GN 2/1
PNC	922607	922608	922609
Grid nr.	5 trays (80 mm pitch)	8 trays (80 mm pitch)	
Dimension WxDxH	428x608x471 mm		428x608x719 mm

- ▶ Include wheels and base supports
- ▶ If used with wheels, slide-in support is required
- ▶ If used with base support it becomes a fixed rack
- ▶ Compatible with **air-o-system ovens**. Slide-in support for air-o-system oven to be ordered as a spare part



Bakery/Pastry trolleys (400x600 mm)*

Oven size	20 GN 1/1	20 GN 2/1
PNC	922761	922762
Grid nr.	16 trays (80 mm pitch)	
Dimension WxDxH	544x841x1695 mm	716x929x1695 mm

- ▶ Include removable handle, bottom tank with a drain, rear wheels with brakes
- ▶ Compatible with air-o-system

Bakery / Pastry fixed racks

Handling solutions



Fixed bakery/pastry racks 400x600 mm*

Oven size	6 GN 1/1	10 GN 1/1
PNC	922655	922656
Grid nr.	5 grids (80 mm pitch)	8 grids (80 mm pitch)

Multipurpose fixed racks

Handling solutions

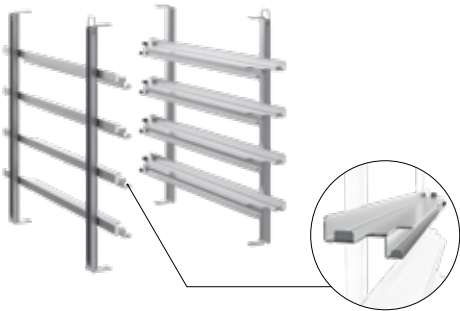

Multipurpose racks for GN and 400x600 mm

Oven size	6 GN 1/1	10 GN 1/1
PNC	922684	922685
Grid nr.	4 grids (80 mm pitch)	7 grids (80 mm pitch)

- ▶ Fit both GastroNorm and 400x600 mm trays
- ▶ For Bakery/Pastry trays (400x600 mm) a specific suction wall is suggested. Suction wall can be purchased at Electrolux Professional Authorized Service Partners

GastroNorm fixed racks

Handling solutions



GastroNorm hanging racks / fixed racks with increased pitch

Oven size	6 GN 1/1	6 GN 2/1	10 GN 1/1	10 GN 2/1
PNC	922740	922681	922741	922742
Grid nr.	5 grids (85 mm pitch)	5 grids (85 mm pitch)	8 grids (85 mm pitch)	8 grids (85 mm pitch)

* When converting to Bakery/Pastry version (400x600 mm) a specific suction wall is suggested. Electrolux Professional recommends to install the correct suction wall in order to guarantee optimal cooking evenness. Suction wall can be purchased at Electrolux Professional Authorized Service Partners.

Cleaning solutions

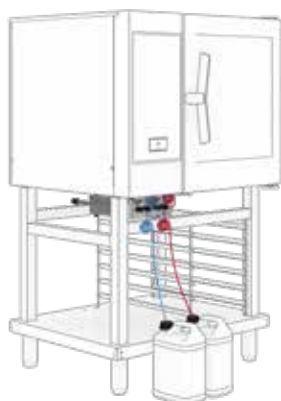

Connection kit to external liquid chemicals

Oven size	6 GN 1/1	6 GN 2/1	10 GN 1/1	10 GN 2/1	20 GN 1/1	20 GN 2/1
PNC	922618					

- ▶ Kit for use automatic cleaning system with liquid detergent and rinse aid
- ▶ Fast and easy installation on-site
- ▶ Equipped with magnets
- ▶ Kit includes pumps, pipes and connections to the tanks



Wall mounted holder for detergent tank

Oven size	6 GN 1/1	6 GN 2/1	10 GN 1/1	10 GN 2/1	20 GN 1/1	20 GN 2/1
PNC	922386					

- ▶ Ideal to keep detergents away from the floor
- ▶ Compatible with OS2282, OS2283



Open base hanging holder for detergent tank

Oven size	6 GN 1/1	6 GN 2/1	10 GN 1/1	10 GN 2/1
PNC	922699			

- ▶ Ideal to keep detergents away from the floor
- ▶ Compatible with OS2282, OS2283



External spray unit

Oven size	6 GN 1/1	6 GN 2/1	10 GN 1/1	10 GN 2/1	20 GN 1/1	20 GN 2/1
PNC	922171					

- ▶ Includes a support to be mounted on the external side panel of the oven

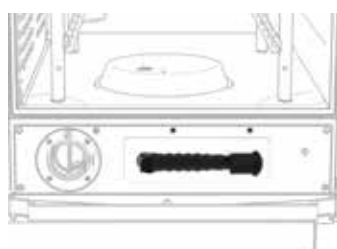

Retractable built-in spray unit for Premium, Pro^S, Pro

Oven size	6 GN 1/1	6 GN 2/1	10 GN 1/1	10 GN 2/1	20 GN 1/1	20 GN 2/1
PNC	0CK749				Available as factory fitted	

- ▶ Table-top ovens: suggested as factory fitted, can also be installed on-site
- ▶ Vertical ovens: to be ordered together with the oven, cannot be installed on site
- ▶ Already included in all Premium^S ovens

Cleaning solutions

SkyClean is an automatic and built-in self cleaning system with **integrated descaling of the steam generator**.

Solid detergents

Ideal for all type of cooking and demanding sites.



C22 Cleaning Tab



Cleaning



C25 Rinse & Descale



Rinse Aid & Descale

Code	Description
0S2395	C22-Cleaning tab phosphate free 100 tabs bucket
0S2394	C25-Rinse & Descale tab phosphate free; 50 tabs bucket

Liquid detergents

Ideal for sites with medium-high dirt level.



C20 ExtraStrong detergent for ovens



C21 ExtraStrong Rinse aid for ovens

	Code	Description
Connection kit	922618	External connection kit for liquid detergent/rinse aid
Cleaning	0S2282	C20 ExtraStrong detergent for ovens; 2 x 5l
Rinse Aid	0S2283	C21 ExtraStrong rinse aid for ovens; 2 x 5l

- ▶ Water treatment to be performed with dedicated water filters and C25 Rinse&Descale tabs (0S2394) for descaling cycle when needed (see page 31)

Starter kit

All SkyLine Ovens are delivered with a sample kit of solid detergents.

Please, note that when using the sample tabs, double quantity is required for cleaning.

Example: 1 C22 cleaning tab 65 gr (0S2395) is equal to 2 C22 sample tabs 30 gr.



Water treatment

Cleaning solutions

Providing the proper water treatment will:

- ▶ avoid the risk of altering the taste and appearance of your foods
- ▶ reduce scale build-up therefore de-liming is less frequent, thus resulting in additional savings in operating costs
- ▶ extend the life of your appliance
- ▶ guarantee lower maintenance costs

Electrolux Professional suggest you to check your water quality in order to choose the right water treatment solution:

- ▶ water softener for high concentration of calcium
- ▶ water nanofilter or reverse osmosis filter for high concentration of calcium and chloride

Water requirements

- ▶ Pressure, bar min/max: 1-4.5
- ▶ Supply: Drinking quality water
- ▶ Max temperature supply water : 30°C
- ▶ Hardness:
 - Boiler ovens: no water treatment is required when daily cleaning with C25 Rinse & Descale is performed
 - Boilerless ovens: < 5°FH

- ▶ Chlorides and conductivity:

	304 boiler	316 boiler	boilerless
Chloride	<17	<20	<10
Conductivity	>285	>285	>285

- ▶ Minimum required conductivity of 70 µS/cm



Automatic water softener
PNC 921305

Oven size: 6 GN 1/1, 6 GN 2/1,
10 GN 1/1, 10 GN 2/1, 20 GN 1/1,
20 GN 2/1

Power kW: 0,04

El. connection: 220/230V

1N 50/60 Hz



External automatic reverse osmosis filter
PNC 864388

Oven size: 6 GN 1/1, 6 GN 2/1,
10 GN 1/1, 10 GN 2/1, 20 GN 1/1,
20 GN 2/1

Power kW: 0,18

El. connection: 220/240V

1N 50/60 Hz



Water filter with cartridge and flow meter
PNC 920004

Oven size:

6 GN 1/1, 6 GN 2/1 and
10 GN 1/1 - low use of steam

Filter capacity: 4675 lt



Water filter with cartridge and flow meter
PNC 920003

Oven size: 10 GN 2/1, 20 GN 1/1,
20 GN 2/1 - high use of steam

Filter capacity: 10800 lt

For more solutions refer to your local presales department.

Bases

Installation solutions



Open bases with GastroNorm tray support

Oven size	6 GN 1/1	6 GN 2/1	10 GN 1/1	10 GN 2/1
PNC	922612	922613	922612	922613
Grid nr.	6 (GN 1/1)	6 (GN 2/1)	6 (GN 1/1)	6 (GN 2/1)
Dimensions WxDxH	865x705x770 mm	1088x901x770 mm	865x705x770 mm	1088x901x770 mm
Material	AISI 304			

- ▶ Supplied with 1 tray support as standard, with the possibility to add a second one
- ▶ The bottom of the bases feature holes for assembling
- ▶ Pre-arranged for an easy installation of the ovens (no need to remove feet)
- ▶ When installing on **air-o-system** base, order compatibility kit PNC 930217 for GN1/1 and 930218 for GN2/1



Cupboard bases with GastroNorm tray support

Oven size	6 GN 1/1	6 GN 2/1	10 GN 1/1	10 GN 2/1
PNC	922614	922616	922614	922616
Grid nr.	6 (GN 1/1)	6 (GN 2/1)	6 (GN 1/1)	6 (GN 2/1)
Dimensions WxDxH	867x775x770 mm	1090x971x770 mm	867x775x770 mm	1090x971x770 mm
Material	AISI 304			

- ▶ Supplied with 1 tray support as standard, with the possibility to add a second one
- ▶ The bottom of the bases feature holes for assembling
- ▶ Pre-arranged for an easy installation of the ovens (no need to remove feet)
- ▶ When installing on **air-o-system** base, order compatibility kit PNC 930217 for GN1/1 and 930218 for GN2/1



GastroNorm tray supports for oven base

Oven size	6 GN 1/1	6 GN 2/1	10 GN 1/1	10 GN 2/1
PNC	922690	922692	922690	922692
Grid nr.	6 (GN 1/1)	6 (GN 2/1)	6 (GN 1/1)	6 (GN 2/1)
Material	AISI 304			

- ▶ To be installed on open and cupboard base with the purpose of providing additional storage
- ▶ To be installed using the pre-arranged holes on the bases
- ▶ Non compatible with **air-o-system** bases

Bases

Installation solutions



Bakery/Pastry tray support for oven base (400x600 mm trays)

Oven size	6 GN 1/1	10 GN 1/1
PNC	922702	
Grid nr.	6	
Material	AISI 304	

- ▶ Bakery/Pastry runners for 400 x 600 mm trays (bakery/pastry) on open and cupboard bases
- ▶ Non compatible with **air-o-system** bases



Hot cupboard bases with multipurpose tray support

Oven size	6 GN 1/1	6 GN 2/1	10 GN 1/1	10 GN 2/1
PNC	922615	922617	922615	922617
Grid nr.	5 (GN 1/1) 6 (400x600)	5 (GN 2/1)	5 (GN 1/1) 6 (400x600)	5 (GN 2/1)
Dimension WxDxH	867x775x770 mm	1090x971x770 mm	867x775x770 mm	1090x971x770 mm
Power	2,5 kW	2,5 kW	2,5 kW	2,5 kW
Electric connection	230V 1N 50 Hz	230V 1N 50 Hz	230V 1N 50 Hz	230V 1N 50 Hz
Material	AISI 304			

- ▶ Ideal for proving and holding
- ▶ Supplied with 1 tray support as standard
- ▶ Pre-arranged for an easy installation of the ovens (no need to remove feet)
- ▶ When installing on **air-o-system** base, order compatibility kit PNC 930217 for GN1/1 and 930218 for GN2/1

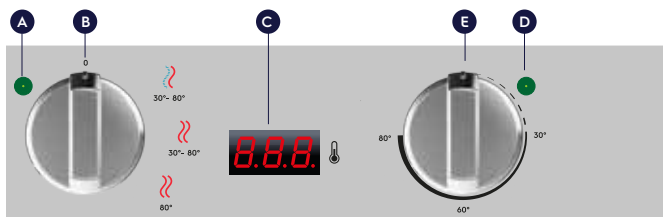

Control panel description

- A** Indicator lamp showing that the appliance is switched on
- B** Selector for humidifying and heating phases
- C** Digital thermoregulator (30 - 80°C)
- D** Indicator lamp showing that the heating is on
- E** Thermostat for adjusting the chamber temperature

Bases

Installation solutions



Wheels kit for oven bases

Oven size	6 GN 1/1	6 GN 2/1	10 GN 1/1	10 GN 2/1
PNC	922003			

- ▶ Ideal for cleaning behind the oven
- ▶ 2 swivelling wheels with brakes and 2 fixed wheels without brakes
- ▶ If mounted on gas ovens, a flexible pipe is required



Flanged feet kit

Oven size	6 GN 1/1	6 GN 2/1	10 GN 1/1	10 GN 2/1
PNC	922351			
Height	100-130 mm			
Material	AISI 304			

- ▶ All 20 GN 1/1 and 20 GN 2/1 ovens are delivered with flanged feet as standard



Disassembled bases

Oven size	6 GN 1/1	10 GN 1/1	6 GN 2/1	10 GN 2/1
PNC	922653		922654	
Dimensions WxDxH	867x707x670 mm		1090x903x670 mm	
Dimensions packaging	750x920x130 mm		940x1140x110 mm	
Material	AISI 304			

- ▶ Delivered disassembled for easier and more convenient transportation
- ▶ Assembly time: less than 10 minutes
- ▶ NO accessory can be installed with the exception of the tray supports for disassembled base (see below)



Tray supports for disassembled bases

Oven size	6 GN 1/1	10 GN 1/1	6 GN 2/1	10 GN 2/1
PNC	922382		922384	
Grids nr.	4 GN 1/1		4 GN 2/1	

Bases

Installation solutions



Wall supports

Oven size	6 GN 1/1	6 GN 2/1	10 GN 1/1
PNC	922643	922644	922645

- ▶ Ideal for space-saving
- ▶ Feasibility of the installation has to be evaluated by an architect/ structural engineer - depending on the type of wall

Wall fixing kit

Oven size	6 GN 1/1	6 GN 2/1	10 GN 1/1	10 GN 2/1	20 GN 1/1	20 GN 2/1
PNC	922687					

- ▶ To secure the oven to the wall

Ventilation

Installation solutions



Odour reduction hoods

Oven size	6 GN 1/1	6 GN 2/1	10 GN 1/1	10 GN 2/1	20 GN 1/1
PNC	922718	922719	922718	922719	922720
Material	AISI 304				
Note	for electric models only				
Dimension WxDxH	875x1070 x450 mm	1098x1266 x450 mm	875x1070 x450 mm	1098x1266 x450 mm	917x1085 x450 mm

- ▶ Fan motor with 3 automatic speeds
- ▶ Complete ventilation system which eliminates the need for an exhaust duct with external connection
- ▶ Multiple filtration systems: prefiltering of exhaust steam through stainless steel labyrinth filters; demister filter and extra droplets separator acting as a steam-liquid separator
- ▶ UV system attacks the fat molecules eliminating unpleasant odours and bacteria; post-filters restrain the residual odours and no reacted ozone
- ▶ Automatic door opening activation system
- ▶ Double step door opening (PNC 922265) is suggested to improve filtering performance (for table-top only)
- ▶ Possibility to activate air purification system when the oven is in stand by (not cooking) or in cleaning phase
- ▶ Ideal for high temperature cooking or intensive usage



Odour reduction hoods for stacked ovens

Oven size	6 GN 1/1 on 6 GN 1/1	6 GN 1/1 on 10 GN 1/1	6 GN 2/1 on 6 GN 2/1	6 GN 2/1 on 10 GN 2/1
PNC	922722		922721	
Material	AISI 304			
Note	for electric models only			
Dimension WxDxH	875x1191x450 mm		1098x1266x450 mm	

- ▶ Fan motor with 3 automatic speeds
- ▶ Complete ventilation system which eliminates the need for an exhaust duct with external connection
- ▶ Multiple filtration systems: prefiltering of exhaust steam through stainless steel labyrinth filters; demister filter and extra droplets separator acting as a steam-liquid separator
- ▶ UV system attacks the fat molecules eliminating unpleasant odours and bacteria; post-filters restrain the residual odours and no reacted ozone
- ▶ Automatic door opening activation system
- ▶ Double step door opening (PNC 922265) is suggested to improve filtering performance
- ▶ Possibility to activate air purification system when the oven is in stand by (not cooking) or in cleaning phase
- ▶ Ideal for high temperature cooking or intensive usage

Ventilation

Installation solutions



Condensation hoods

Oven size	6 GN 1/1	6 GN 2/1	10 GN 1/1	10 GN 2/1	20 GN 1/1
PNC	922723	922724	922723	922724	922725
Material	AISI 304				
Note	for electric models only				
Dimension WxDxH	875x1070 x450 mm	1098x1266 x450 mm	875x1070 x450 mm	1098x1266 x450 mm	917x1085 x472 mm

- ▶ Fan motor with 3 automatic speeds
- ▶ Complete ventilation system which eliminates the need for an exhaust duct with external connection
- ▶ Multiple filtration systems: prefiltering of exhaust steam through stainless steel labyrinth filters; demister filter and extra droplets separator acting as a steam-liquid separator
- ▶ Automatic door opening activation system
- ▶ Double step door opening (PNC 922265) is suggested to improve filtering performance (for table-top only)
- ▶ In case of high temperature cooking or intensive usage the Odour Reduction Hood is recommended
- ▶ Condensation hood for 20 GN 1/1 is delivered with a kit for quenching system update (spare part 0CK731) for better steam management



Condensation hoods for stacked ovens

Oven size	6 GN 1/1 on 6 GN 1/1	6 GN 1/1 on 10 GN 1/1	6 GN 2/1 on 6 GN 2/1	6 GN 2/1 on 10 GN 2/1
PNC	922727		922726	
Material	AISI 304			
Note	for electric models only			
Dimension WxDxH	875x1191x450 mm		1098x1266x450 mm	

- ▶ Fan motor with 3 automatic speeds
- ▶ Complete ventilation system which eliminates the need for an exhaust duct with external connection
- ▶ Multiple filtration systems: prefiltering of exhaust steam through stainless steel labyrinth filters; demister filter and extra droplets separator acting as a steam-liquid separator
- ▶ Automatic door opening activation system
- ▶ Double step door opening (PNC 922265) is suggested to improve filtering performance
- ▶ In case of high temperature cooking or intensive usage the Odour Reduction Hood is recommended

Ventilation

Installation solutions



Standard Hoods (with fan motor)

Oven size	6 GN 1/1	6 GN 2/1	10 GN 1/1	10 GN 2/1	20 GN 1/1
PNC	922728	922729	922728	922729	922730
Material	AISI 304				
Dimension WxDxH	875x1070 x450 mm	1098x1266 450 mm	875x1070 x450 mm	1098x1266 450 mm	917x1085 x450 mm

- ▶ Fan motor with 3 automatic speeds
- ▶ Requires connection to an external exhaust air duct
- ▶ Equipped with a mechanical labyrinth filter
- ▶ Automatic door opening activation system
- ▶ Double step door opening (922265) is suggested to improve filtering performance (for table-top only)



Standard Hoods (with fan motor) for stacked ovens

Oven size	6 GN 1/1 on 6 GN 1/1	6 GN 1/1 on 10 GN 1/1	6 GN 2/1 on 6 GN 2/1	6 GN 2/1 on 10 GN 2/1
PNC	922732		922731	
Material	AISI 304			
Dimension WxDxH	875x1191x450 mm		1098x1266x450 mm	

- ▶ Fan motor with 3 automatic speeds
- ▶ Requires connection to an external exhaust air duct
- ▶ Equipped with a mechanical labyrinth filter
- ▶ Automatic door opening activation system
- ▶ Double step door opening (922265) is suggested to improve filtering performance

Ventilation

Installation solutions



Hoods without fan motor

Oven size	6 GN 1/1	6 GN 2/1	10 GN 1/1	10 GN 2/1	20 GN 1/1
PNC	922733	922734	922733	922734	922735
Material	AISI 304				
Dimension WxDxH	875x1070 450 mm	1098x1266 450 mm	875x1070 450 mm	1098x1266 450 mm	917x1085 450 mm

- ▶ Requires connection to an external exhaust air duct
- ▶ Equipped with a mechanical labyrinth filter
- ▶ Double step door opening (922265) is suggested to improve filtering performance (for table-top only)

Hoods without fan motor for stacked ovens

Oven size	6 GN 1/1 on 6 GN 1/1	6 GN 1/1 on 10 GN 1/1	6 GN 2/1 on 6 GN 2/1	6 GN 2/1 on 10 GN 2/1
PNC	922737		922736	
Material	AISI 304			
Dimension WxDxH	875x1191x450 mm		1098x1266x450 mm	

- ▶ Requires connection to an external exhaust air duct
- ▶ Equipped with a mechanical labyrinth filter
- ▶ Double step door opening (922265) is suggested to improve filtering performance

Ventilation

Installation solutions

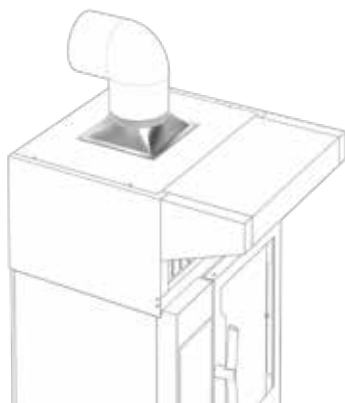

Hood hopper

Oven size	6 GN 1/1	6 GN 2/1	10 GN 1/1	10 GN 2/1	20 GN 1/1
PNC	922751				
Dimension WxDxH	360x360x100 mm				

- ▶ Ideal to directly connect the hood to the centralized ventilation system
- ▶ Only for Standard Hoods (with fan motor) and Hoods without fan motor,
- ▶ Available also for stacked ovens



Riser for 6 GN 1/1 on base with hood

Oven size	6 GN 1/1
PNC	922632
Dimension WxDxH	829x669x390 mm
Material	AISI 304

- ▶ Ideal for raising 6 GN 1/1 oven when placed under dedicated hood (enables more comfortable operation, as it adds over 25 cm in height)



Flue condenser

Oven size	6 GN 1/1	6 GN 2/1	10 GN 1/1	10 GN 2/1	20 GN 1/1	20 GN 2/1
PNC	922678					
Note	all gas models					
Dimension WxDxH	406x305x255 mm					

- ▶ Ideal for gathering gas and fumes coming out of the oven and exhausting them through a flue

Ventilation

Installation solutions



Extension for condensation tube

Oven size	6 GN 1/1	6 GN 2/1	10 GN 1/1	10 GN 2/1	20 GN 1/1	20 GN 2/1
PNC	922776					
Note	all models					
Extension Height	370 mm					

- ▶ Ideal to convey steam and vapor from the exhaust tube



Steam optimizer

Oven size	6 GN 1/1	6 GN 2/1	10 GN 1/1	10 GN 2/1
PNC	922750			
Note	all models			
Material	AISI 304			

- ▶ Ideal for improving uniformity of steam distribution with partial load, by retaining vapor in the cavity.
- ▶ Recommended for condensation hood, to be installed on table top ovens

Stacking kits

Installation solutions



Stacking kits oven on oven

Oven size	6 GN 1/1 on 6 GN 1/1	6 GN 1/1 on 10 GN 1/1	6 GN 2/1 on 6 GN 2/1	6 GN 2/1 on 10 GN 2/1
PNC	922620 (el.) 922622 (gas)	922620 (el.) 922623 (gas)	922621 (el.) 922624 (gas)	922621 (el.) 922625 (gas)
Dimension WxDxH	867x895x120 mm (el.) 867x895x150 mm (gas)		1090x1092x120 mm (el.) 1090x1092x150 mm (gas)	
Total height installation	electric: 1736 mm gas: 1766 mm	electric: 1986 mm gas: 2016 mm	electric: 1736 mm gas: 1766 mm	electric: 1986 mm gas: 2016 mm
Material	AISI 304			

- ▶ Ideal for saving space in the kitchen
- ▶ Include: supports, external panels, flue and water pipes, drain connection and adjustable feet
- ▶ Can be mounted on site
- ▶ Typology (gas, electric) must be ordered considering the oven that will be placed at the bottom
- ▶ 6 GN 1/1 electric oven can be stacked on top of **air-o-system** 6 GN 1/1 electric oven by using compatibility kit PNC 922679 together with stacking kit for **air-o-system** range PNC 922319 (or corresponding spare part)



Risers for stacked oven

Oven size	6 GN 1/1 on 6 GN 1/1	6 GN 2/1 on 6 GN 2/1
PNC	922632 (with feet); 922635 (with wheels)	922633 (with feet); 922634 (with wheels)
Dimension WxDxH	829x669x390 mm (feet) 835x675x390 mm (wheels)	1052x865x390 mm (feet) 1058x871x390 mm (wheels)
Material	AISI 304	

- ▶ Ideal for easy cleaning and to raise bottom oven for easier operations



Wheels for stacked oven

Oven size	6 GN 1/1 on 6 GN 1/1	6 GN 2/1 on 6 GN 2/1	6 GN 1/1 on 10 GN 1/1	6 GN 2/1 on 10 GN 2/1
PNC	922704			
Material	AISI 304			

- ▶ Ideal for cleaning behind the oven
- ▶ 2 swivelling wheels with brakes and 2 fixed wheels without brakes
- ▶ If mounted on gas ovens, a flexible pipe is required

Stacking kits

Installation solutions



Trolleys for mobile racks for stacked ovens

Oven size	6 GN 1/1 on 6 & 10 GN 1/1	6 GN 2/1 on 6 & 10 GN 2/1	6 GN 1/1 on 6 GN 1/1	6 GN 2/1 on 6 GN 2/1
PNC	922630	922631	922628 (on riser)	922629 (on riser)
Material	AISI 304			

- ▶ Ideal for easy and safe load and unload of mobile racks on top and bottom ovens
- ▶ Compatible with mobile GastroNorm, Bakery/Pastry and Banqueting racks
- ▶ Trolleys for mobile racks for stacked ovens are compatible with air-o-system ovens

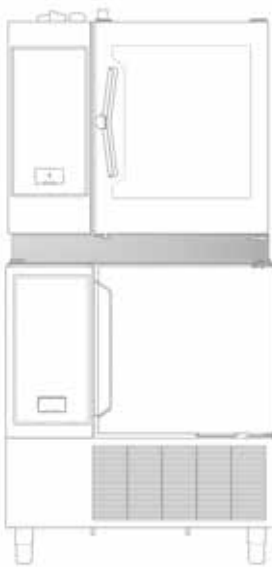

Stacking kit 6 GN 1/1 oven on 30 kg blast chiller

Oven size	6 GN 1/1
Blast chiller size	30 kg
PNC	880565
Dimension WxDxH	895x765x100 mm
Total height installation	1832 mm (on feet)
Material	AISI 304

- ▶ Ideal for saving space in the kitchen
- ▶ Includes: supports, external panels and drain connection
- ▶ Can be mounted on site
- ▶ Not required if ordering Chill^s code for tower execution (PNC 727729)
- ▶ Compatible with high adjustable feet kit (PNC 922745)
- ▶ In case a 6 GN 1/1 air-o-steam (or air-o-convect) oven has to be stacked on the 30 kg Chill^s blast chiller order stacking kit 880586*
- ▶ Compatible with left hinged door ovens and blast chillers
- ▶ Compatible with air-o-chill



Wheels for stacked oven on blast chiller

Oven size	6 GN 1/1
Blast chiller size	30 kg
PNC	880676
Material	AISI 304

- ▶ Ideal for cleaning behind the oven
- ▶ 2 swivelling wheels with brakes and 2 fixed wheels without brakes
- ▶ If mounted on gas ovens, a flexible pipe is required

* Previous air-o-chill stacking kits 881049 and 881175 can be used only with right hinged door 30 kg Chill^s blast chiller

Stacking kits

Installation solutions



Stacking kit 6 GN 1/1 oven on 15-25 kg crosswise blast chiller/freezer



Oven size	6 GN 1/1
Blast chiller size	5 GN crosswise
PNC	922657
Dimension WxDxH	872x775x1040 mm
Total height installation	1873 mm (6 GN 1/1)
Material	AISI 304

- ▶ Ideal for saving space in the kitchen
- ▶ Can be mounted on site
- ▶ Compatible with blast chiller/freezer: 725208, 725212, 725209, 725213, 725446

Miscellaneous

Installation solutions



Left hinged door

Oven size	6 GN 1/1	6 GN 2/1	10 GN 1/1	10 GN 2/1
PNC	0CK383			
Family	all			

- ▶ Suggested as factory fitted, can also be replaced on-site



Double-step door opening

Oven size	6 GN 1/1	6 GN 2/1	10 GN 1/1	10 GN 2/1
PNC	922265			

- ▶ Ideal for increasing operating safety:
 - The first step gradually lets the steam out, without a complete door opening
 - The second step allows a complete door opening

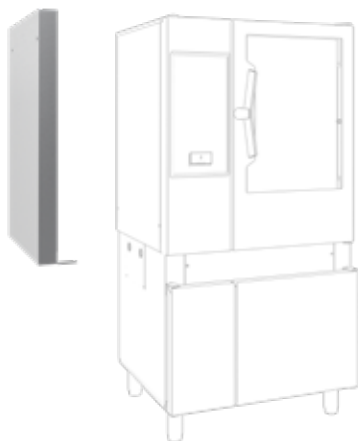

Heat shields

Oven size	6 GN 1/1	6 GN 2/1	10 GN 1/1	10 GN 2/1	20 GN 1/1	20 GN 2/1
PNC	922662	922665	922663	922664	922659	922658
Family	all					

- ▶ Ideal for protecting left side of the oven (electronics) from overheating caused by closeness to strong heat sources (ex. charbroilers, stoves...)
- ▶ 70 mm thickness

Miscellaneous

Installation solutions



Heat shields for stacked ovens

Oven size	6 GN 1/1 on 6 GN 1/1	6 GN 2/1 on 6 GN 2/1	6 GN 1/1 on 10 GN 1/1	6 GN 2/1 on 10 GN 2/1
PNC	922660	922666	922661	922667
Family	all			

- ▶ Ideal for protecting left side of the oven (electronics) from overheating caused by closeness to strong heat sources (ex. charbroilers, stoves...)
- ▶ 70 mm thickness



Entry ramps

Oven size	20 GN 1/1	20 GN 2/1
PNC	922715	922716
Material	AISI 304	

- ▶ Ideal for easily and safely inserting and removing the mobile rack to and from the oven in case of unlevelled kitchen floor
- ▶ Suggested with trolley from SkyLine range
- ▶ Mandatory in case of uneven floor. Maximum slope allowed is 1%: 1 mm every 100 mm



Holder for trolley handle

Oven size	20 GN 1/1	20 GN 2/1
PNC	922743	
Material	AISI 304	

- ▶ Ideal for hanging the handle of the trolley when the latest is inside the oven

Miscellaneous

Installation solutions



4 height adjustable feet with black plastic cover kit

Oven size	6 GN 1/1	6 GN 2/1	10 GN 1/1	10 GN 2/1
PNC	922693			
Height	100-115 mm			
Material	AISI 304 and black plastic			



Flanged feet kit

Oven size	6 GN 1/1	6 GN 2/1	10 GN 1/1	10 GN 2/1
PNC	922351			
Height	100-130 mm			
Material	AISI 304			

- ▶ Ideal for fixing the appliance to the floor
- ▶ For safely securing the appliance in marine installations preventing tilting and slipping
- ▶ All 20 GN1/1 and 20 GN2/1 ovens are delivered with flanged feet as standard
- ▶ Marine versions of ovens (dedicated PNC) are delivered with flanged feet as standard



4 height adjustable feet kit for 6 & 10 grids ovens

Oven size	6 GN 1/1	6 GN 2/1	10 GN 1/1	10 GN 2/1
PNC	922745			
Height	230-290 mm			
Material	AISI 304			

- ▶ Ideal for cleaning below the oven



4 adjustable wheels kit for 20 grids ovens

Oven size	20 GN 1/1	20 GN 2/1
PNC	922701	

- ▶ Ideal for cleaning behind the oven
- ▶ Adjustable height (± 6 mm)
- ▶ 2 swivelling wheels with brakes and 2 fixed wheels without brakes
- ▶ If mounted on gas ovens, a flexible pipe is required

Miscellaneous

Installation solutions

Kits to convert from LPG to natural gas and viceversa

Oven size	6 GN 1/1	6 GN 2/1	10 GN 1/1	10 GN 2/1	20 GN 1/1	20 GN 2/1
PNC	922671 (LPG to natural gas) 922670 (Natural gas to LPG)					

- ▶ In case of conversion of 6 GN 1/1 or 6 GN 2/1 ovens from Natural Gas to LPG, also chimney 922706 is needed

Kit for installation of electric power peak management system

Oven size	6 GN 1/1	6 GN 2/1	10 GN 1/1	10 GN 2/1	20 GN 1/1	20 GN 2/1
PNC	922774				922778	

- ▶ Required to set up equipment for third party power peak management system

Drain installation kits

Oven size	6 GN 1/1	6 GN 2/1	10 GN 1/1	10 GN 2/1	20 GN 1/1	20 GN 2/1
PNC	922636 (AISI304) 922637 (plastic)				922738 (AISI304) 922739 (plastic)	

SkyLine family

Blast Chiller Freezers



Size	6GN1/1	10GN1/1	10GN2/1	20GN1/1	20GN2/1
Capacity (chilling/freezing) - kg	30/30	50/50	100/70	100/85	150/120 200/170
Interface	Touch screen	Touch screen	Touch screen	Touch screen	Touch screen
Refrigerant	R452	R452	R452	R452	R452
Configuration	Built-in / Remote	Built-in / Remote	Built-in / Remote	Remote	Built-in / Remote
Temperature range	-41 ÷ 40 °C	-41 ÷ 40 °C	-41 ÷ 40 °C	-41 ÷ 40 °C	-41 ÷ 40 °C
Automatic chilling	Yes	Yes	Yes	Yes	Yes
Special cycles	Cruise chilling, Proving, Retarder Proving, Fast Thawing, Sushi&Sashimi, Sous Vide (Chilling), Ice cream, Yogurt, Chocolate			Cruise chilling, Fast Thawing, Sushi&Sashimi, Sous Vide (Chilling), Ice cream, Yogurt	
Core probe	3-sensors	3-sensors	3-sensors	3-sensors	3-sensors
Fan speed levels	7	7	7	1	1
Programs	1000 (16 phases)	1000 (16 phases)	1000 (16 phases)	1000 (16 phases)	1000 (16 phases)
Hygiene functions	Yes	Yes	Yes	Yes	Yes
OnE Connectivity	Optional*	Optional*	Optional*	Optional*	Optional*
SkyDuo	Yes	Yes	Yes	Yes	Yes

* A limited range of standard codes OnE Connectivity ready is also available

Food probe

Chilling solutions



3-sensor probe for blast chiller freezer

BCF size	6 GN 1/1	6 GN 2/1	10 GN 1/1	10 GN 2/1	20 GN 1/1	20 GN 2/1
PNC	880582					

- ▶ Equipped as a standard accessory in all products of the range



6-sensor probe for blast chiller freezer

BCF size	6 GN 1/1	6 GN 2/1	10 GN 1/1	10 GN 2/1	20 GN 1/1	20 GN 2/1
PNC	880566					

- ▶ Optional accessory in alternative to the standard 3 sensor probe for even more precise measurement
- ▶ Can be requested as a factory fitted accessory.



USB 3 single-sensor probe for blast chiller freezer

BCF size	6 GN 1/1	6 GN 2/1	10 GN 1/1	10 GN 2/1	20 GN 1/1	20 GN 2/1
PNC	880567					

- ▶ To be used in addition to the standard 3 sensor probe
- ▶ Ideal when it is required to have multipoint testing
- ▶ Not recommended for continuous usage



USB 1 single-sensor probe for blast chiller freezer

BCF size	6 GN 1/1	6 GN 2/1	10 GN 1/1	10 GN 2/1	20 GN 1/1	20 GN 2/1
PNC	881292					

- ▶ To be used as a backup solution to replace built-in single-sensor probe in case it is accidentally damaged
- ▶ Not recommended for continuous usage

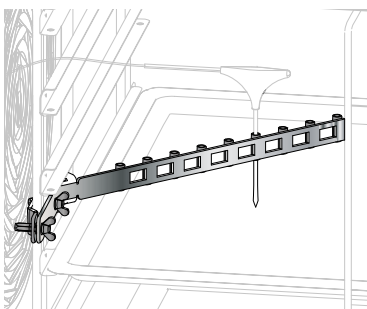

Probe holder for liquid

Oven size	6 GN 1/1	6 GN 2/1	10 GN 1/1	10 GN 2/1	20 GN 1/1	20 GN 2/1
BCF size	all					
PNC	922714					
Material	AISI 304					

Handling

Chilling solutions

Stainless steel runners

Oven and blast chiller/freezer size	6 GN 1/1	10 GN 1/1	10 GN 2/1
PNC	880587		880588
Material	AISI 304		

Remote units

Chilling solutions

Blast chiller/freezer size	6 GN 1/1	10 GN 1/1	10 GN 2/1	20 GN 1/1	20 GN 2/1	2x 20 GN 2/1
Air	880577	881221	881222	881223	881224 (200 kg) 881269 (150 kg)	881225
Water	880603	881226	881227	881228	881229 (200 kg) 881270 (150 kg)	
Air/water				881230		

► Note: Check installation requirements and water consumption values

Installation

Chilling solutions



Wheels for blast chiller freezer

Oven and blast chiller/freezer size	6 GN 1/1	10 GN 1/1	10 GN 2/1
PNC	881284		881285
Material	AISI 304		

- ▶ Ideal for cleaning behind the blast chiller freezer
- ▶ 2 swivelling wheels with brakes and 2 fixed wheels without brakes (PNC 881285 has 2 additional swivelling wheels without brake)



Wheels for stacked oven on blast chiller

Oven Size	6 GN 1/1
PNC	880676
Material	AISI 304

- ▶ Ideal for cleaning behind the blast chiller freezer
- ▶ 2 swivelling wheels with brakes and 2 fixed wheels without brakes
- ▶ If mounted on gas ovens, a flexible pipe is required
- ▶ Equipped with rear fixing bracket to safety fix the tower on the wall



Flanged feet for blast chiller freezer

Oven and blast chiller freezer size	6 GN 1/1	10 GN 1/1	10 GN 2/1	20 GN 1/1	20 GN 2/1
PNC	880589				
Material	AISI 304				



Worktop for 6 GN 1/1 blast chiller freezer

Oven Size	6 GN 1/1	
Door	Right hinged	Left hinged
PNC	880581	881238
Material	AISI 304	

Seamless communication

A world of digital seamless connected solutions that simplify your work and help your business develop.



OnE Connected

Gives real time access to your appliance from any smart device.

Use it to share recipes and monitor information, such as status, statistics, HACCP data and consumptions. Available for SkyLine Premium^S, Premium, Pro^S and Pro Combi Ovens and Chill^S Blast Chiller/Freezers.

OnE Connected setup

SkyLine Ovens and Blast Chiller/Freezers can be connected via Connectivity kit to customer's local router. Once connected, all OnE Connected services are available.

Connectivity kit 922421



- supports both WiFi  and cable connection 
- one kit for each appliance

Connectivity kit can be ordered as an optional accessory. SkyLine ovens and Blast Chiller/Freezers can also be requested as "connectivity ready" from the factory (connectivity kit already installed).

When both SkyLine Premium^S/Pro^S Oven and Blast Chiller/Freezer are connected via Connectivity kit, SkyDuo can be activated with no additional accessories required.



WiFi or cable connection to local router

Note:

1. The use of OnE Connected services requires a license agreement provided by Electrolux Professional. You can find details of the services including availability and cost at <https://www.electroluxprofessional.com/about-us/one-connected/>
2. The maximum number of connected appliances supported by a single router depends on the capabilities of the router itself.
3. All components will be installed and commissioned during the installation of the appliances by Electrolux Professional Authorized Service Partners.

A duo made for success

Revolutionize the way you work with stress-free, time-saving, high performing SkyLine Ovens and Blast Chiller/Freezers.

SkyDuo



Stress-free efficiency and productivity with SkyDuo. Anticipating your needs with the self-intuitive connection between SkyLine Premium^S/Pro^S Ovens and SkyLine Chill^S and viceversa. The appliances guide you through the Cook&Chill process.

SkyDuo setup

SkyLine Premium^S/Pro^S Ovens and Blast Chiller/Freezers can be connected either directly via cable or via Connectivity kit.

Connectivity kit 922421



- supports both WiFi  and cable connection  when activated via customer's local router
- one kit for each appliance
- allows direct connection between two appliances via cable in case OnE Connected services are not required

Connectivity kit can be ordered as an optional accessory. SkyLine ovens and Blast Chiller/Freezers can also be requested as "connectivity ready" from the factory (connectivity kit already installed).



Internet connection is not required
(if not using OnE Connected services)

Note:

1. In case of use of SkyDuo only (without OnE Connected), internet connection is not required. In this case, for a more stable communication, oven and blast chiller can be directly connected via cable (peer-to-peer connection), without the need of the router.
2. All components will be installed and commissioned during the installation of the appliances by Electrolux Professional Authorized Service Partners.

Connectivity

Installation solutions



Super antenna WiFi and 3G amplifier kit

Oven size	6 GN 1/1	6 GN 2/1	10 GN 1/1	10 GN 2/1	20 GN 1/1	20 GN 2/1
PNC	922765					



Antenna cable RF LLC200A, length 10m

Appliance size	6 GN 1/1	6 GN 2/1	10 GN 1/1	10 GN 2/1	20 GN 1/1	20 GN 2/1
PNC	922779					



Connectivity hub (LAN) Router Ethernet + WiFi

Oven size	6 GN 1/1	6 GN 2/1	10 GN 1/1	10 GN 2/1	20 GN 1/1	20 GN 2/1
PNC	922412					



Connectivity hub (SIM) Router Ethernet + WiFi + 4G (UE)

Oven size	6 GN 1/1	6 GN 2/1	10 GN 1/1	10 GN 2/1	20 GN 1/1	20 GN 2/1
PNC	922399					



Excellence is central to everything we do.
By anticipating our customers' needs, we strive for
Excellence with our people, innovations, solutions and services.
To be the OnE making our customers' work-life easier,
more profitable – and truly sustainable every day.

Follow us on



www.electroluxprofessional.com

Excellence with the environment in mind

- ▶ All our factories are ISO 14001-certified
- ▶ All our solutions are designed for low consumption of water, energy, detergents and harmful emissions
- ▶ In recent years over 70% of our product features have been updated with the environmental needs of our customers in mind
- ▶ Our technology is RoHS and REACH compliant and over 95% recyclable
- ▶ Our products are 100% quality tested by experts

