

**CUOCI PASTA E700 XP
PASTA COOKER E700 XP**

PNC	Model	Ref	Brand	Version	Notes
371090	E7PCGD1KF0	a	ELX	GAS	1X24.5 LT WELL 400MM
371091	E7PCGH2KF0	b	ELX	GAS	2X24.5 LT WELLS 800MM
371098	E7PCED1KF0	c	ELX	EL	1X24.5 LT WELL 400MM
371099	E7PCEH2KF0	d	ELX	EL	2X24.5 LT WELLS 800MM
371350	E7PCGD1KF0	a	ELX	GAS	1-WELL GAS PASTA COOKER 24,5 LT 400MM-WATERMARK
371351	E7PCGH2KF0	b	ELX	GAS	2-WELL GAS PASTA COOKER 2X24,5 LT 800MM-WATERMARK
371352	E7PCED1KF0	c	ELX	EL	1-WELL EL. PASTA COOKER 24,5 LT 400MM-WATERMARK
371353	E7PCEH2KF0	d	ELX	EL	2-WELL EL. PASTA COOKER 2X24,5 LT 800MM-WATERMARK
372090	Z7PCGD1KF0	e	ZAN	GAS	1X24.5 LT WELL 400MM
372091	Z7PCGH2KF0	f	ZAN	GAS	2X24.5 LT WELLS 800MM
372098	Z7PCED1KF0	g	ZAN	EL	1X24.5 LT WELL 400MM
372099	Z7PCEH2KF0	h	ZAN	EL	2X24.5 LT WELLS 800MM
372350	Z7PCGD1KF0	e	ZAN	GAS	1-WELL GAS PASTA COOKER 24,5 LT 400 MM-WATERMARK
372351	Z7PCGH2KF0	f	ZAN	GAS	2-WELL GAS PC 2X24,5 LT 800 MM-WATERMARK
372352	Z7PCED1KF0	g	ZAN	EL	1-WELL EL. PC 24,5 LT 400 MM-WATERMARK
372353	Z7PCEH2KF0	h	ZAN	EL	2-WELL EL. PC 2X24,5 LT 800 MM-WATERMARK
373090	A7PCGD1KF0	i	OEM	GAS	1X24.5 LT WELL 400MM
373091	A7PCGH2KF0	l	OEM	GAS	2X24.5 LT WELLS 800MM
373098	A7PCED1KF0	m	OEM	EL	1X24.5 LT WELL 400MM
373099	A7PCEH2KF0	n	OEM	EL	2X24.5 LT WELLS 800MM
373232	A7PCGD1KFK	o	KIP	GAS	1X24.5 LT WELL 400MM
373233	A7PCGH2KFK	p	KIP	GAS	2X24.5 LT WELLS 800MM
373234	A7PCED1KFK	q	KIP	EL	1X24.5 LT WELL 400MM
373350	A7PCGD1KF0	i	OEM	GAS	1-WELL GAS PC 24,5 LT 400 MM-WATERMARK
373351	A7PCGH2KF0	l	OEM	GAS	2-WELL GAS PC 2X24,5 LT 800 MM-WATERMARK
373352	A7PCED1KF0	m	OEM	EL	1-WELL EL. PC 24,5 LT 400 MM-WATERMARK
373353	A7PCEH2KF0	n	OEM	EL	2-WELL EL. PC 2X24,5 LT 800MM-WATERMARK

Index

General view / Vista generale	Page	Notes
	2	
Idraulic circuit (water) / Componenti imp.idraulico (acqua)	3	From S/N 3 38 (2013)
Gas components / Componenti gas	4	
Electric components / Componenti elettrici	5	From S/N 8251 PDX2018-03
Pasta baskets / Cestelli pasta	6-7	
Ugelli / Nozzles	8	
Spare parts list / Lista ricambi	9-11	
Maintenance kit / Kit di manutenzione	12	

Bold=last change / Grassetto =ultima modifica

Rev. 12

From Ser. Nr.338 Up to Ser. Nr.	Ed. 2014-04 Updated 2021-04	Page: 1	Doc No:59785FF00
------------------------------------	--------------------------------	---------	------------------

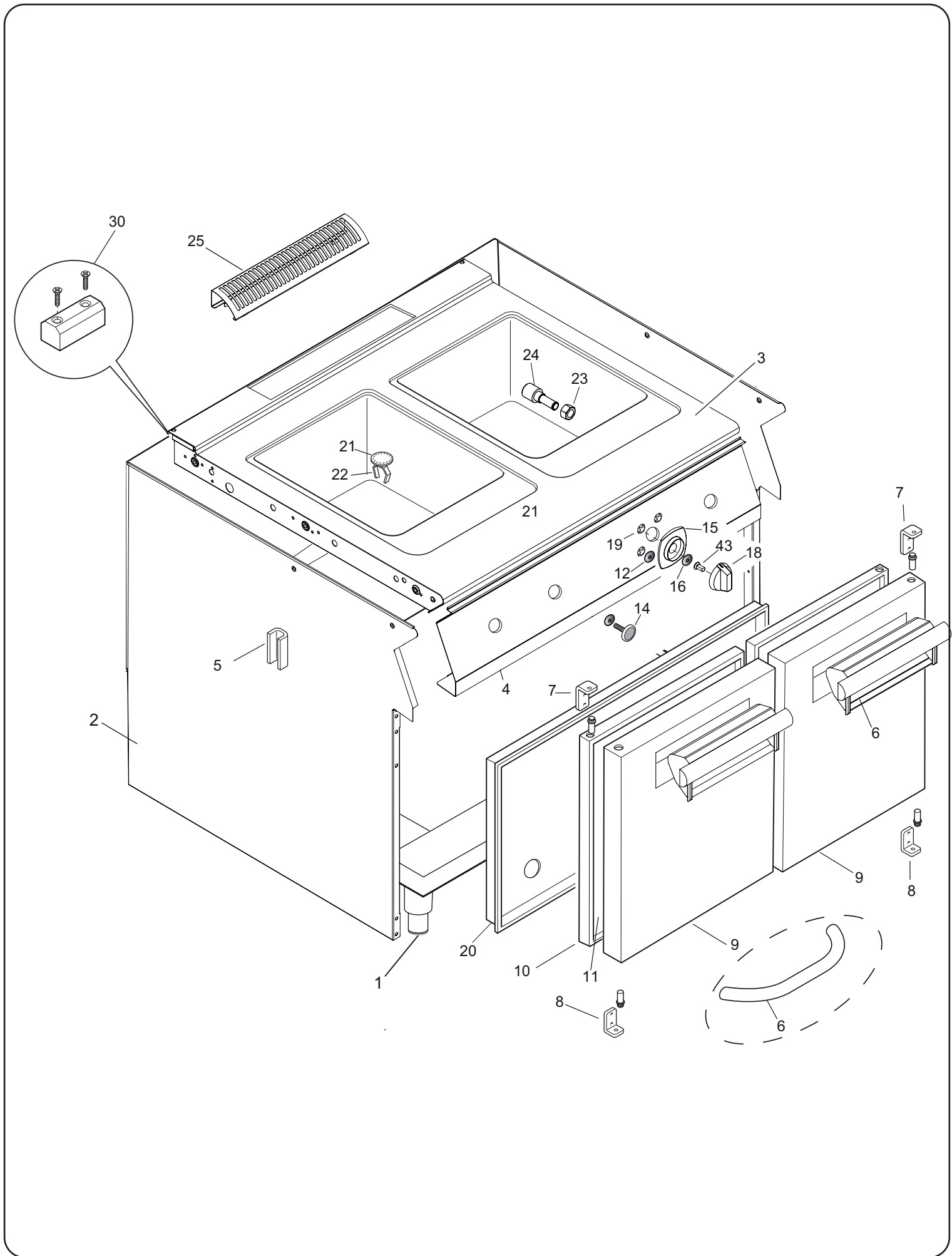

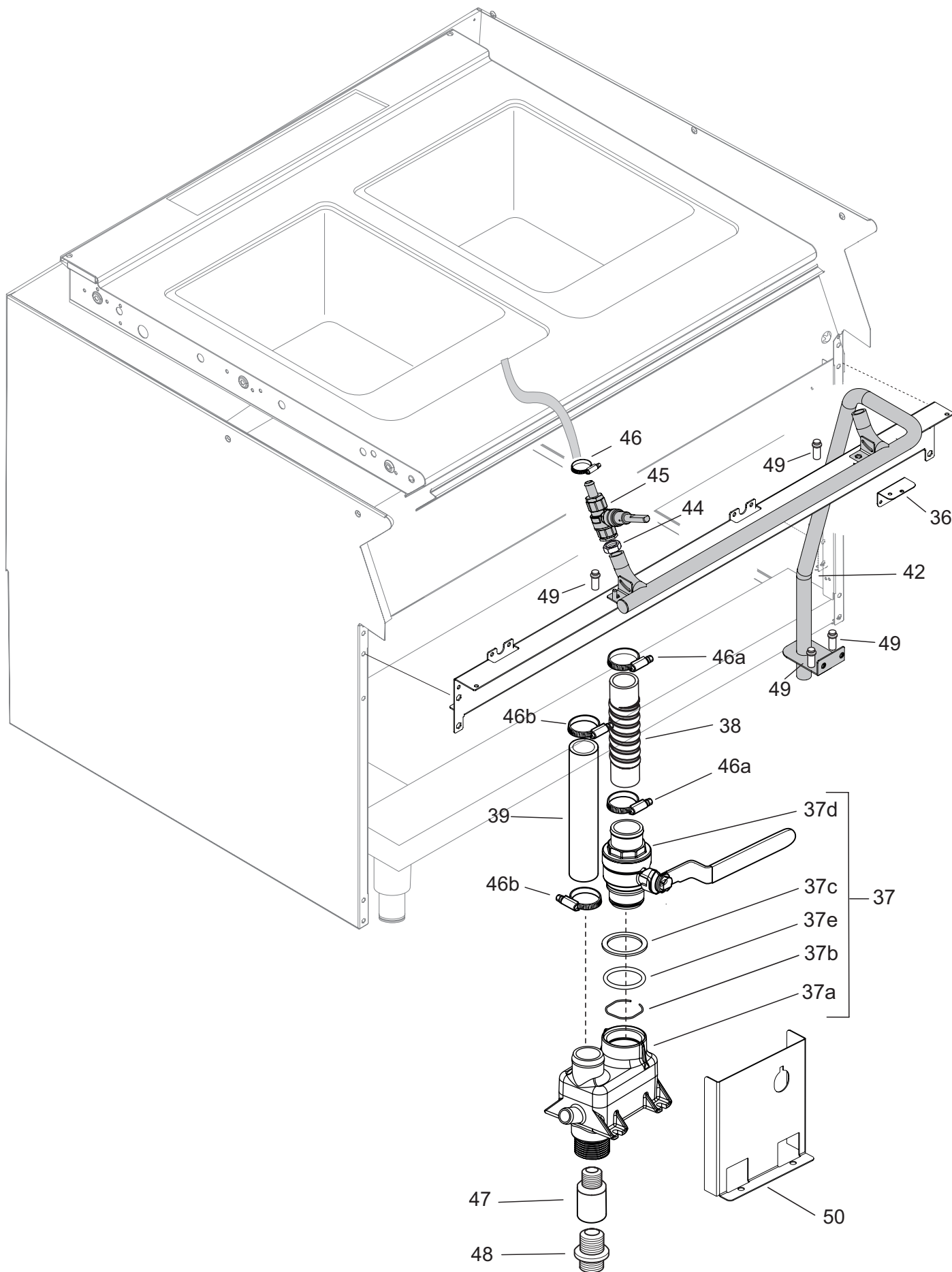

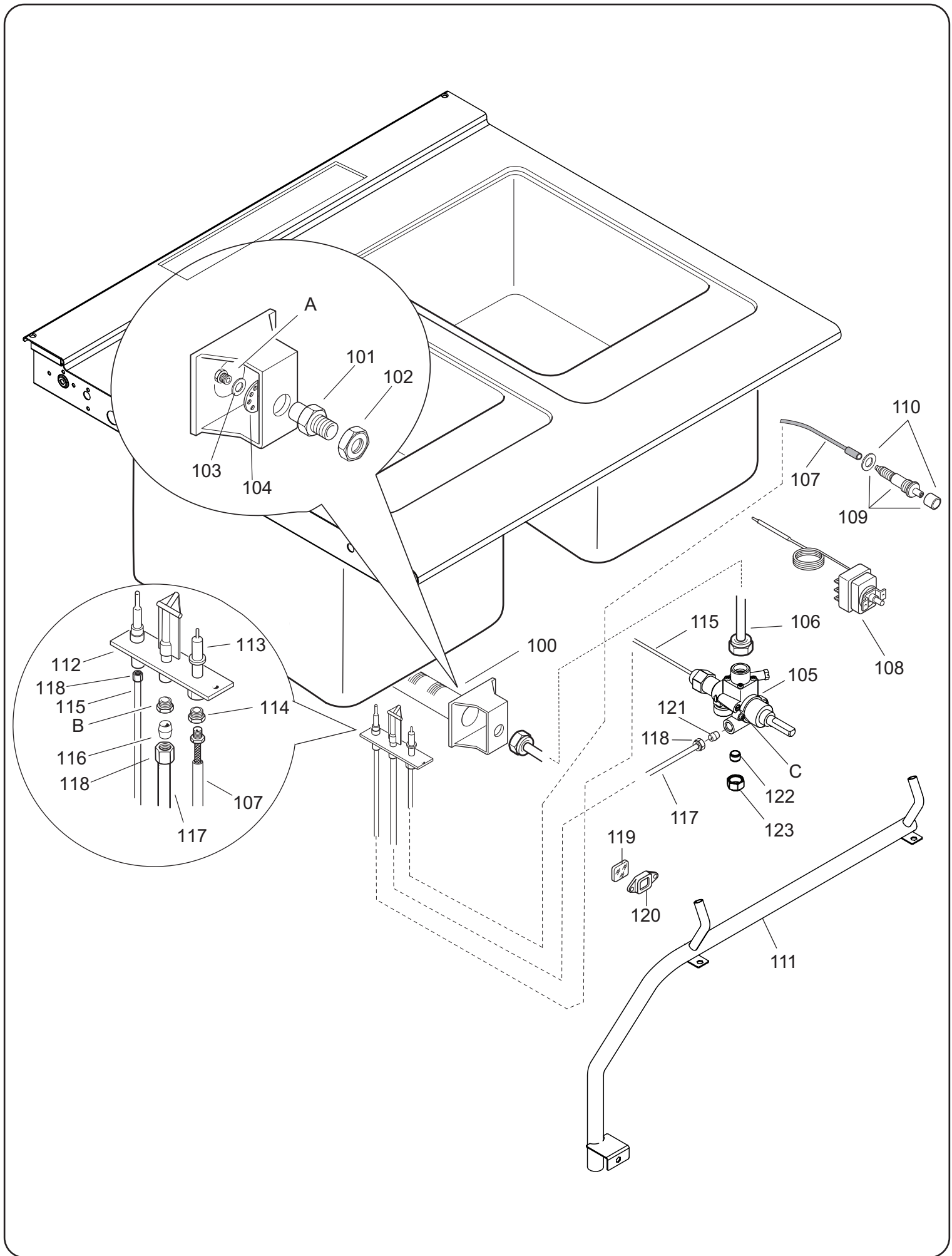

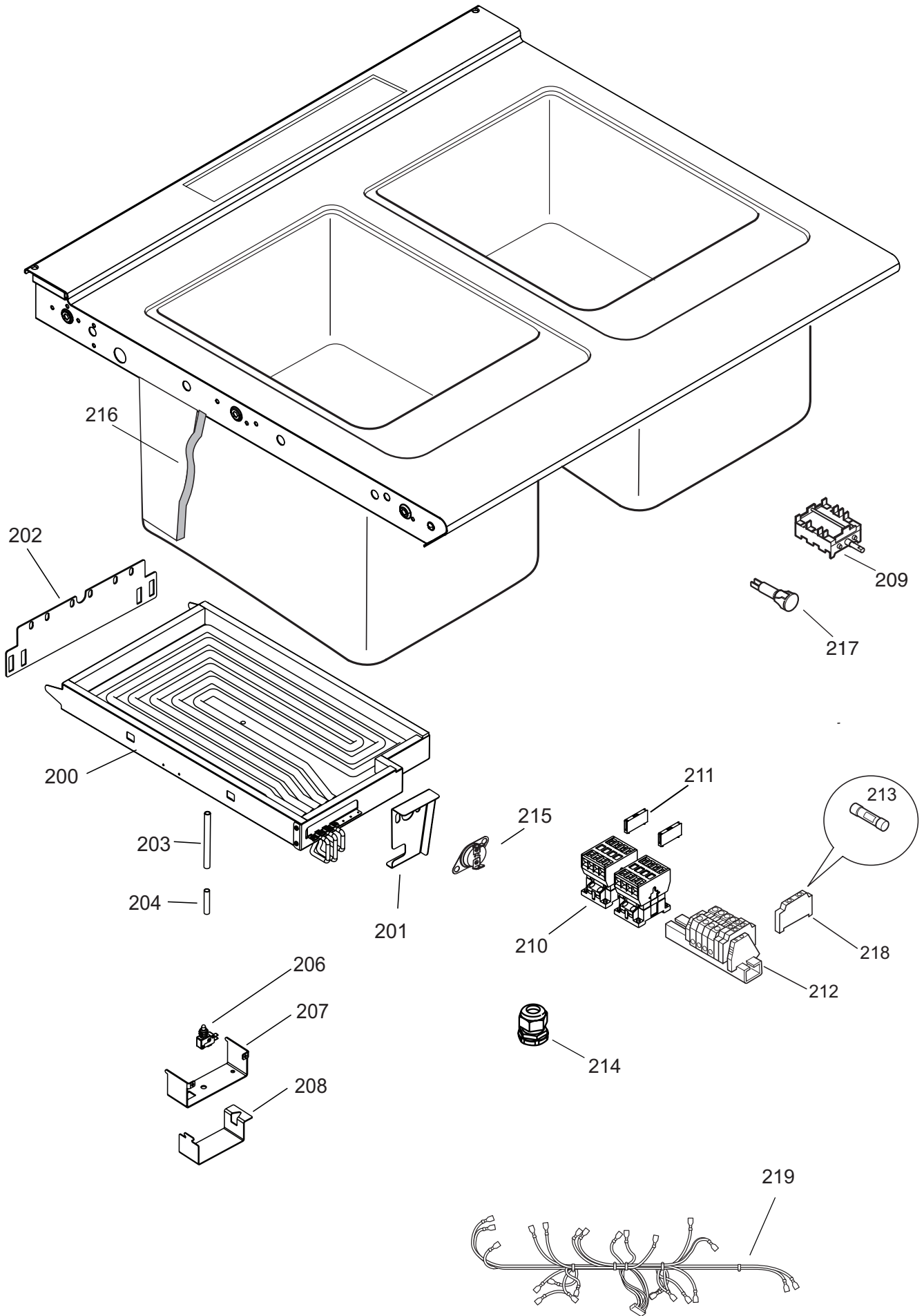



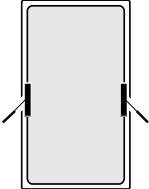

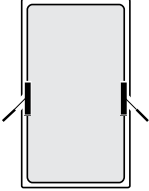

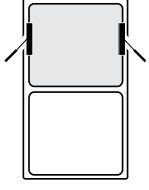

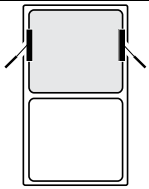

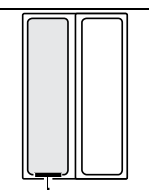

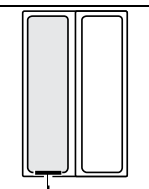

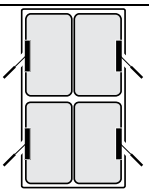

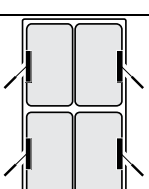

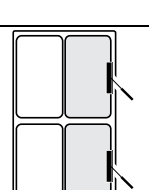



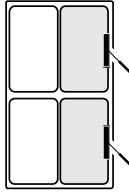

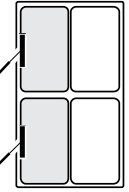

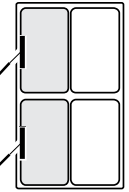

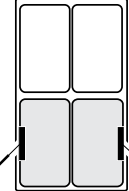

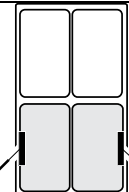

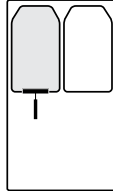

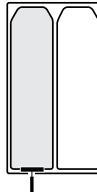

Actual wire harness may be different from illustration.

CODE	DESCRIPTION	DIMENSION			NOTES
004874 877894401	Basket AISI 304 for pastacooker PNC 921611	L = 220 mm P = 350 mm A = 265 mm			Up to 2017/49
004874 877894403	Basket AISI 304 for pastacooker PNC 921611	L = 220 mm P = 350 mm A = 240 mm			From 2017/50
004875 830817802	Basket AISI 304 for pastacooker PNC 921610	L = 220 mm P = 170 mm A = 265 mm			Up to 2017/49
004875 830817804	Basket AISI 304 for pastacooker PNC 921610	L = 220 mm P = 170 mm A = 240 mm			From 2017/50
004873 830818001	Lengthwise basket AISI 304 for pastacooker PNC 921619	L = 105 mm P = 350 mm A = 265 mm			Up to 2017/49
004873 830818003	Lengthwise basket AISI 304 for pastacooker PNC 921619	L = 105 mm P = 350 mm A = 240 mm			From 2017/50
2x OCA258 (2 x 0C9226+ 2 x 0C9227)	Kit, 4 square baskets, AISI 304 for pastacooker (need to work on top code 004876)	L = 105 mm P = 160 mm A = 265 mm			Up to 2017/49
2x 0CB360 (2x 83089NL00 + 2x 83089NK00)	Kit, 4 square baskets, AISI 304 for pastacooker (need to work on top code 004876)	L = 105 mm P = 160 mm A = 240 mm			From 2017/50
2x 0C9226 2x 83089JG02	Kit, 2 RIGHT square baskets, AISI304 for pastacooker (need to work on top code 004876)	L = 105 mm P = 160 mm A = 265 mm			Up to 2017/49

CODE	DESCRIPTION	DIMENSION			NOTES
2x 83089NL00	Kit, 2 RIGHT square baskets, AISI 304 for pastacooker (need to work on top code 0CB362)	L = 105 mm P = 160 mm A = 240 mm			From 2017/50
2x 0C9227 2x 830821103	Kit, 2 LEFT square baskets, AISI 304 for pastacooker (need to work on top code 004876)	L = 105 mm P = 160 mm A = 265 mm			Up to 2017/49
2x 83089NK00	Kit, 2 LEFT square baskets, AISI 304 for pastacooker (need to work on top code 0CB362)	L = 105 mm P = 160 mm A = 240 mm			From 2017/50
0CA258 9F92101800 (87589FC00)	Kit, 2 square baskets (left & right) AISI 304 for pastacooker (need to work on top code 004876)	L = 105 mm P = 160 mm A = 265 mm			Up to 2017/49
0CB360 87589G500 (83089NL00 + 83089NK00)	Kit, 2 square baskets (left & right) AISI 304 for pastacooker (need to work on top code 0CB362)	L = 105 mm P = 160 mm A = 240 mm			From 2017/50
006886 830892902 206312	Single portion basket, AISI 304 for electronic automatic pastacookers	L = 100 mm P = 165 mm A = 123 mm			
0C9539 87889BJ02 206314	Lengthwise basket, AISI 304 for electronic automatic pastacookers	L = 105 mm P = 350 mm A = 123 mm			
004876 877894800	False bottom, AISI 304 for pastacooker	L = 230 mm P = 350 mm A = 30 mm			Up to 2017/49
0CB362 87889FR00	False bottom, AISI 304 for pastacooker	L = 230 mm P = 350 mm A = 60 mm			From 2017/50

A - Ugello bruciatore / Burner nozzle			
Spare Code	Reference		
002905	ø1.60	3+3B/P	G30 30mbar
003722	ø1.55	3B/P	G30 37mbar
004488	ø1.40	3B/P	G30 50mbar
002267	ø2.45	2H/2E+	G20 20mbar
002865	ø2.30	2H	G20 25mbar
002268	ø2.60	2L	G25 25mbar
059363	ø2.50	2K	G25.3 25mbar
003371	ø2.75	2ELL	G25 20mbar
002268	ø2.60	2S	G25.1 25mbar
0C3079	ø6.25	No CE	G110 8mbar

B - Ugello Pilota / Burner nozzle			
Spare Code	Reference		
054286	n°24	3+3B/P	G30 30mbar
054286	n°24	3B/P	G30 37mbar
054286	n°24	3B/P	G30 50mbar
054037	n°25	2H/2E+	G20 20mbar
054037	n°25	2H	G20 25mbar
054037	n°25	2L	G25 25mbar
054037	n°25	2K	G25.3 25mbar
054037	n°25	2ELL	G25 20mbar
054037	n°25	2S	G25.1 25mbar
054038	n°45	No CE	G110 8mbar

C - Vite Minimo / Min Screw			
Spare Code	Reference		
004733	85	3+3B/P	G30 30mbar
004733	85	3B/P	G30 37mbar
003213	75	3B/P	G30 50mbar
052607	140	2H/2E+	G20 20mbar
052607	140	2H	G20 25mbar
052607	140	2L	G25 25mbar
052607	140	2K	G25.3 25mbar
052607	140	2ELL	G25 20mbar
052607	140	2S	G25.1 25mbar
/	adjust	No CE	G110 8mbar

CUOCI PASTA E700 XP
PASTA COOKER E700 XP

Pos	Factory Code	Spare Code	Descrizione	Description	Ref./Notes
1	835856900	0C0204	PIEDE	FOOT	
2	85089FD01	*	ASSIEME FASCIA 400	SIDE PANEL 400	a,c
2	85089FF01	*	ASSIEME FASCIA 800	SIDE PANEL 800	b,d
2	85089FH01	*	ASSIEME FASCIA 400	SIDE PANEL 400	e,g,i,m, O,Q
2	85089FJ01	*	ASSIEME FASCIA 800	SIDE PANEL 800	f, h, l, n,P
3	87089BK01	0C7218	RIPIANO / VASCA 400 MM	WORKTOP / TANK 400mm	a
3	87089BL01	0CB285	RIPIANO / VASCA 800 MM	WORKTOP / TANK 800mm	b
3	87089BM01	0C7628	RIPIANO / VASCA 400 MM	WORKTOP / TANK 400mm	c
3	87089BN01	0C7629	RIPIANO / VASCA 800 MM	WORKTOP / TANK 800mm	d
3	87089MC01	0C7632	RIPIANO / VASCA 400 MM	WORKTOP / TANK 400mm	e, i, o
3	87089MD01	0C7633	RIPIANO / VASCA 800 MM	WORKTOP / TANK 800mm	f, l, p
3	87089BR00	*	RIPIANO / VASCA 400 MM	WORKTOP / TANK 400mm	g, m, q
3	87089BS00	*	RIPIANO / VASCA 800 MM	WORKTOP / TANK 800mm	h, n
4	85089BF00	0C7620	CRUSCOTTO 400mm	CONTROL PANEL 400mm	c
4	85089AF00	0C7136	CRUSCOTTO 800mm	CONTROL PANEL 800mm	d
4	85089AB00	0C7135	CRUSCOTTO 400mm	CONTROL PANEL 400mm	a
4	85089BD00	0C7138	CRUSCOTTO 800mm	CONTROL PANEL 800mm	b
4	85089FN00	0C7389	CRUSCOTTO 400mm	CONTROL PANEL 400mm	g
4	85089FP00	0C7390	CRUSCOTTO 800mm	CONTROL PANEL 800mm	h
4	87089GY00	0C7222	CRUSCOTTO 400mm	CONTROL PANEL 400mm	e
4	85089FM00	0C7388	CRUSCOTTO 800mm	CONTROL PANEL 800mm	f
4	502899K00	0C8024	CRUSCOTTO 400mm	CONTROL PANEL 400mm	i,O
4	502899Y00	0C8025	CRUSCOTTO 800mm	CONTROL PANEL 800mm	l,P
4	502899Z00	0C8026	CRUSCOTTO 400mm	CONTROL PANEL 400mm	m,Q
4	502899N00	0C8027	CRUSCOTTO 800mm	CONTROL PANEL 800mm	n
5	527850500	0C0156	PIASTRA FISSAGGIO FIANCHI	SIDE PANEL JOINTING PLATE	
6	51589A700	0C7164	MANIGLIA	HANDLE	a,b,c,d
6	54887A802	0C8190	MANIGLIA	HANDLE	e,f,g,h
6	854864203	0A5021	MANIGLIA	HANDLE	i,l,m,n,O,P,Q
7	516860901	0C0139	CERNIERA SUP.	UPPER. HINGE, DOOR	
8	516860801	0C0138	CERNIERA INF.	BOTTOM HINGE, DOOR	
9	50389G300	0C7156	PORTA (SENZA MANIGLIA)	DOOR (WITHOUT HANDLE)	a,b,c,d, e,f,g,h
9	50389MB01	*	PORTA (SENZA MANIGLIA)	DOOR (WITHOUT HANDLE)	i,l,m,n, O,P,Q
10	50489CQ00	0C7158	CONTROPORTA	INNER DOOR OVEN	
11	565819900	0C4433	DISTANZIALE PORTA	DOOR SPACER	
*	85089AA02	0C7156	ASSIEME PORTA (SENZA MANIGLIA)	COMPLETE DOOR (NO HANLE)	a,b,c,d, e,f,g,h
12	541813800	0C6171	RONDELLA IN SILICONE	SILICONE WASHER	
14	830898200	0C0201	MAGNETE	MAGNET, DOOR	
15	548877Y00	0C7134	GHIERA COMMUTATORE ELETTRICO	RING, KNOB SWITCH ELECTRIC	Electric, ELX
15	548876G01	0C6802	GHIERA RUBINETTO ACQUA	RING, KNOB WATER REGULATION	Water ELX
15	548877X00	0C7178	GHIERA RUBINETTO GAS	RING, KNOB GAS REGULATION	Gas, ELX
15	54887A400	0C7386	GHIERA COMMUTATORE ELETTRICO	RING, KNOB SWITCH ELECTRIC	Electric,ZAN, OEM, KIP
15	54887A300	0C7938	GHIERA RUBINETTO GAS	RING, KNOB GAS REGULATION	GAS,ZAN, OEM,KIP
15	548879H00	0C7385	GHIERA RUBINETTO ACQUA	RING, KNOB WATER REGULATION	Water,ZAN, OEM, KIP
16	543821000	053816	GUARNIZIONE X MANOPOLA	GASKET, KNOB	
18	54887AW00	0C8646	MANOPOLA GAS ED ACQUA	KNOB GAS AND WATER TAP	a,b,c,d,
18	548878001	0C7180	MANOPOLA RUBINETTO ACQUA	KNOB WATER TAP	e,f,g,h
18	548878201	0C7232	MANOPOLA GAS E COMMUTATORE	KNOB, GAS AND REGULATOR	e,f,g,h
18	548865700	0C1380	MANOPOLA RUBINETTO ACQUA	KNOB WATER TAP	i,l,m,n

CUOCI PASTA E700 XP
PASTA COOKER E700 XP

Pos	Factory Code	Spare Code	Descrizione	Description	Ref./Notes
18	548865500	0A5621	MANOPOLA GAS E COMMUTATORE	KNOB, GAS AND REGULATOR	i,l,m,n
18	548876V00	0C8295	MANOPOLA	KNOB	O,P,Q
18	548876X00	0C6747	MANOPOLA GAS E COMMUTATORE	KNOB, GAS AND REGULATOR	O,P,Q
19	218912211	069567	MOLLETTA PER GHIERA	RING, RING KNOB	
20	50489Y400	*	PANNELLO FRONTALE 400mm	FRONTAL PANEL 400mm	
20	50489Y500	0CB629	PANNELLO FRONTALE 800mm	FRONTAL PANEL 800mm	
21	506864501	004836	FILTRO FONDO	BOTTOM FILTER	
22	514848300	054905	MOLLA PER FILTRO FONDO	SPRING, FILTER	
23	214105101	020997	CONTRODADO GETTO	WATER TAP NUT	
24	511832001	0C5935	GETTO ACQUA	WATER TAP	
25	50389LP00	0C7333	GRIGLIA CAMINO	CHIMNEY GRID	
26	F921618	0C9225	KIT CESTELLO 105X160	KIT BASKET 105X160	KIT OF 2 LEFT + 2 RIGHT BASKET
26*	*	0C9226	KIT CESTELLO 105X160	KIT BASKET 105X160	2 RIGHT BASKET
26*	*	0C9227	KIT CESTELLO 105X160	KIT BASKET 105X160	2 LEFT BASKET
27	F921619	004873	CESTELLO 105X350	BASKET 105X350	
28	F921611	004874	CESTELLO 220X350	BASKET 220X350	
28a	F921610	004875	CESTELLO 220X170	BASKET 220X170	
29	F921606	004876	GRIGLIA DI FONDO	FALSE BOTTOM, PASTA COOKER	
30	*	0C9655	KIT PIASTRA GIUNZIONE	KIT JOINTING REAR PLATE	Screws and bracket
36	50689DY00	0C9743	DOMA FORATURA	DRILL JIG	TB PDX2013-03
37	855899X02	0C6953	ASSIEME RACCORDO DI SCARICO	COMPLETE DRAIN JUNCTION	Up to 5481...
37	855899X06	0CA490	ASSIEME RACCORDO DI SCARICO	CONTACTOR 32A 230V	From 5491... (37a+37b+37c+37d+37e)
37a	544825903	0CA570	RACCORDO	JUNCTION	From 5491...
37b	516899A02	0CA571	ANELLO ELASTICO	SEIGER RING	From 5491...
37c	206800101	0CA463	ROSETTA PIANA	WASHER	From 5491...
37d	80589A303	0CA464	VALVOLA A SFERA	BALL VALVE	From 5491...
37e	543827500	0C6800	OR	OR	From 5491...
38	544825Q00	0C9199	TUBO SCARICO	DRAIN PIPE	Up to 5201 LENGTH 160MM
38	544826000	0CA374	TUBO SCARICO	DRAIN PIPE	From 5211 LENGTH 160MM
39	544825F00	0C7133	TUBO TROPPO PIENO	OVERFLOW FULL PIPE	LENGTH 510MM
40	543827500	0C6800	OR	OR	
42	83089JZ01	0C9633	RIBALTA ACQUA AISI	WATER PIPE STAINLESS STEEL	1x40 WELL a,c,e,g,i,m
42	83089KF02	0C9740	KIT COMPLETO RIBALTA AISI	KIT WATER INLET PIPE	TB PDX2013-03 1x40 WELL a,c,e,g,i,m
42	83089K001	0C9634	RIBALTA ACQUA AISI	WATER PIPE STAINLESS STEEL	2x40 WELL b,d,f,h,l,n
42	83089KG02	0C9741	KIT COMPLETO RIBALTA AISI	KIT WATER INLET PIPE	TB PDX2013-03 2x40 WELL b,d,f,h,l,n
43	548877V00	0C7345	ADATTATORE MANOPOLA	KNOB, ADAPTER	a,b,c,d
44	516875100	0C8993	DADO FISSAGGIO	FIXING NUT	
45	835877Z00	0C9635	RUBINETTO+PROLUNGA , CARICO	WATER TAP + EXTENSION, INLET	
46	518613100	049888	FASCETTA GETTO ACQUA	CLAMP BAND WATER NOZZLE	
46a	518825C00	0C9201	FASCETTA SCARICO ACQUA	CLAMP BAND DISCHARGE WATER	
46b	518613300	0L2728	FASCETTA TROPPOPIENO	CLAMP BAND OVERFLOW WATER	
47	511851900	0C9205	MANICOTTO	EXTENSION	Up to WK38-2013...
48	511851800	0C9204	NIPPLO 1" 7/1	GAS CONNECTION 1" 7/1	Up to WK38-2013
49	518803100	0C7118	INSERTO FILETTATO M5	THREADED RIVET M5	FIXING OF POS.42
50	50589L700	*	PIASTRINA SCARICO	DRAIN PLATELET INDICATOR	Except for KIP
50	505899T03	OTTA07	PIASTRINA SCARICO	METAL PANEL, DRAIN	Except for KIP
100	83089D301	0C6795	BRUCIATORE	BURNER	

CUOCI PASTA E700 XP
PASTA COOKER E700 XP

Pos	Factory Code	Spare Code	Descrizione	Description	Ref./Notes
101	514829700	054118	PORTAUGELLO	INJECTOR HOLDER	
102	214105101	020997	CONTRODADO	LOCK NUT	
103	506833401	054029	GUARNIZIONE	GASKET	
104	830828001	054039	AERATORE	AERATOR	
105	835875R01	0C8647	RUBINETTO GAS	GAS TAP	
106	80589AN00	0C8029	CONDOTTA GAS	GAS PIPE	
107	80589BY00	0C9198	CAVETTO ACCENSIONE CON GUAINA	SPARK PLUG CABLE (sheathed)	LENGTH 700MM
108	646810102	005931	TERMOSTATO SIC. LIMITATORE	SAFETY THERMOSTAT	
109	835834901	0C9240	KIT ACCENDITORE (ACCEND+TAP-PO+RONDEL)	KIT IGNITER (IGNITER+BUTTON+WASHER)	
109	835829600	059251	ACCENDITORE	IGNITER	
109	541809001	0C9407	TAPPO DI GOMMA	RUBBER BUTTON	
109	516814601	0C9408	RONDELLA	WASHER	
110	*	0C9409	TAPPO DI GOMMA + RONDELLA	RUBBER BUTTON + WASHER	
111	83089DD00	0C8030	RIBALTA GAS	INLET GAS PIPE	1x40 WELL a,c,e,g,i,m,o,q
111	83089DA00	0C8031	RIBALTA GAS	INLET GAS PIPE	2x40 WELL b,d,f,h,l,n,p
112	830828100	054032	BRUCIATORE PILOTA	PILOT BURNER	
113	330272401	052610	ELETTRODO ACCENSIONE	SPARK CANDLE	
114	214164101	057960	RACCORDO	PIPE FITTING	
115	831818901	0C3162	TERMOCOPPIA INTERROTTA	THERMOCOUPLE	
116	515827401	053665	BICONO	DOUBLE CONE	
117	51589A901	0C8032	CONDUTTURA PILOTA	PIPE, PILOT	
118	214164400	052125	RACCORDO	PIPE FITTING	
119	206260400	057382	VETRO SPIA	GLASS	
120	275290025	057400	CORNICE VETRO	FRAME	
121	215199700	052127	BICONO	DOUBLE CONE	
122	215170716	050682	OGIVA DA 12	DOUBLE CONE	
123	214111412	050670	DADO M 20 X 1,5	NUT	
200	61783AN00	0CB382	RESISTENZA	HEATING ELEMENT	From 8251 PDX2018-03
201	50289H101	0CB475	SUPPORTO RESISTENZA	HEATING ELEMENT SUPPORT	From 8251 PDX2018-03
202	50489TZ02	0CB474	SUPPORTO STAFFA RESISTENZA	H.E. SUPPORT BRAKET	From 8251 PDX2018-03
203	569807501	0C8182	ASTINA IN STEATITE (CERAMICO)	CERAMIC ROD	
204	51489DT01	0CB496	BOCCOLA OTTONE PER ASTINA	BRAS ROD	From 8251 PDX2018-03
206	640804N00	0CA553	MICRO-INTERRUTTORE	MICROSWITCH	From 8251 PDX2018-03
207	50589JP00	*	BASE PER MICRO	MICROSWITCH BASE	From 7451
208	50789A000	*	PROTEZIONE MICRO	MICROSWITCH PROTECTION	From 7451
209	641805101	0C7353	COMMUTATORE	SWITCH	
210	648807900	0C7622	CONTATTORE	CONTACTOR	
211	H58194500	0C4704	CONTATTO AUSILIARIO	AUXILIARY CONTACT	
212	639806600	006854	MOSETTIERA (completa)	TERMINAL BOARD (assembly)	like picture 212
213	652806400	0C1884	FUSIBILE	FUSE	10°
214	544802300	0C0068	PASSACAVO	TOGHTENER CORD	
215	653800000	0C6155	PROTEZIONE TERMICA	THERMIC SECURITY	c,d,g,h,m,n,Q
216	560857403	0C9888	ISOLAMENTO	INSULATION	c,d,g,h,m,n,Q
217	876800002	005010	LAMPADA VERDE	GREEN LAMP	
218	652603200	075737	PORTAFUSIBILE	FUSE HOLDER TERMINAL	
219	638899T02	0C9678	CABLAGGIO ELETTRICO	WIRING HARNESS	c,g,m,Q

CUOCI PASTA E700 XP
PASTA COOKER E700 XP

Pos	Factory Code	Spare Code	Descrizione	Description	Ref./Notes
219	638899U02	0CA119	CABLAGGIO ELETTRICO	WIRING HARNESS	d,h,n
*	080589FC00	0CB801	KIT WATERMARK	WATERMARK KIT	
*	*	0CB450	Kit manutenzione Cuocipasta gas N700 24,5LT	N700 24,5LT Gas Pasta cooker maintenance Kit	24,5LT Gas Pasta cooker (12+44+45+46+109+112+ 113+114+115+116+118+121+ nozzles TABLE B)
*	*	0CB451	Kit manutenzione Cuocipasta gas N700 24,5LT ogni 3 anni	N700 24,5LT Gas Pasta cooker 3rd year maintenance Kit	24,5LT Gas Pasta cooker (12+44+45+46+2x46b+109+ 112+113+114+115+116+118+121+ nozzles TABLE B+ 0C7133)
*	*	0CB452	Kit manutenzione Cuocipasta elettrici N700 24,5LT	N700 24,5LT Electric Pasta cooker maintenance Kit	24,5LT Electric Pasta cooker (12+44+45+46+217)
*	*	0CB453	Kit manutenzione Cuocipasta elettrici N700 24,5LT ogni 3 anni	N700 24,5LT Electric Pasta cooker 3rd year maintenance Kit	24,5LT Electric Pasta cooker (12+44+45+46+2x46b+217+0C7133)
*	*	0CB454	Kit manutenzione Cuocipasta gas N700 2X 24,5LT	N700 2X 24,5LT Gas Pasta cooker maintenance Kit	2X 24,5LT Gas Pasta cooker (2x12+2x44+2x45+2x46+2x109+2x112+ 2x113+2x114+2x115+2x116+2x118+2x121+ nozzles TABLE B)
*	*	0CB455	Kit manutenzione Cuocipasta gas N700 2X 24,5LT ogni 3 anni	N700 2X 24,5LT Gas Pasta cooker 3rd year maintenance Kit	2X 24,5LT Gas Pasta cooker (2x12+2x44+2x45+2x46+4x46b+ 2x109+2x112+2x113+2x114+2x115+2x116+ 2x118+2x121+ nozzles TABLE B+ 2x0C7133)
*	*	0CB456	Kit manutenzione Cuocipasta elettrici N700 2X 24,5LT	N700 2X 24,5LT Electric Pasta cooker maintenance Kit	2X 24,5LT Electric Pasta cooker (2x12+2x44+2x45+2x46+2x217)
*	*	0CB457	Kit manutenzione Cuocipasta elettrici N700 2X 24,5LT ogni 3 anni	N700 2X 24,5LT Electric Pasta cooker 3rd year maintenance Kit	2X 24,5LT Electric Pasta cooker (2x12+2x44+2x45+2x46+4x46b+2x217+2x0C7133)