

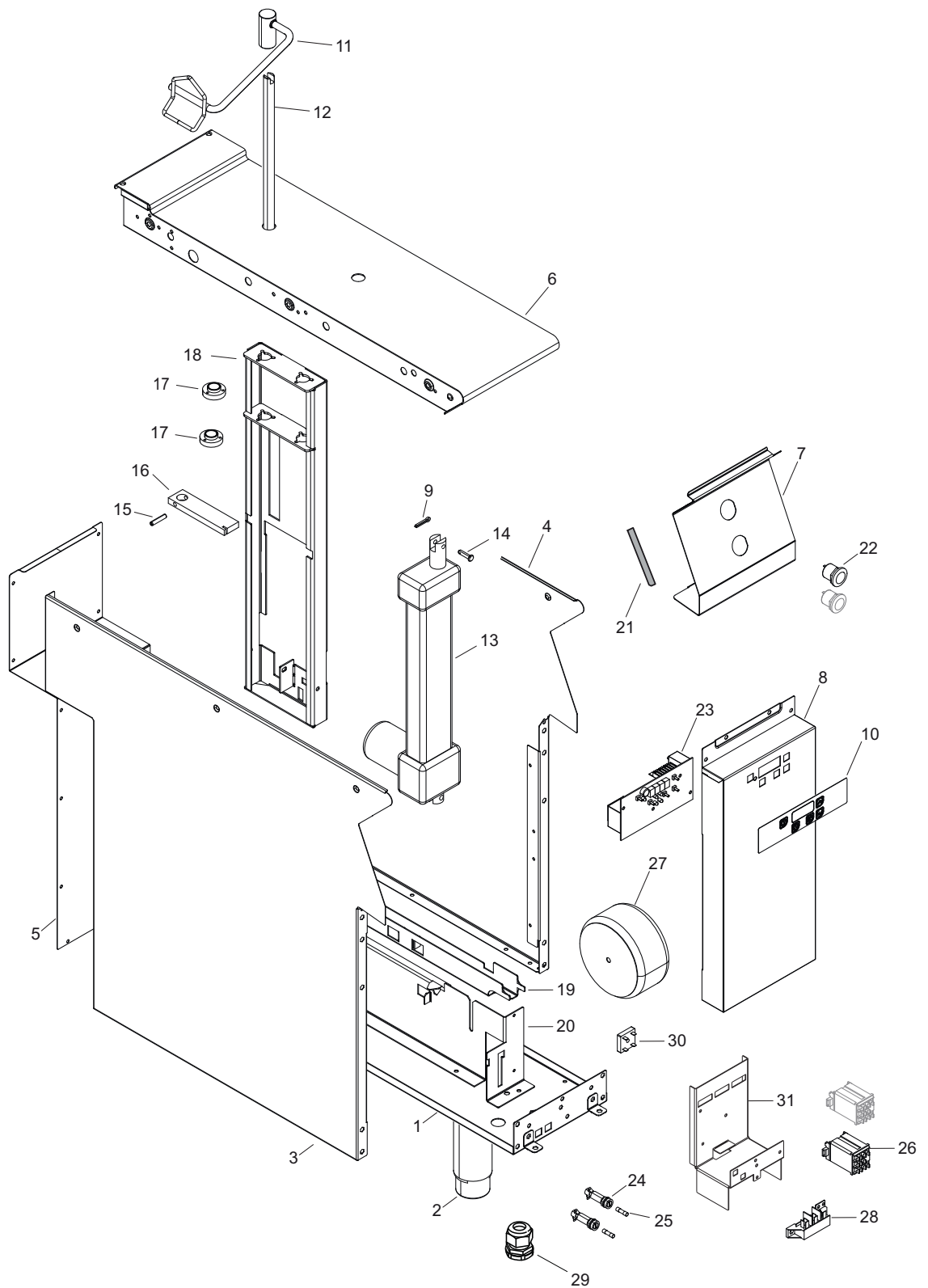

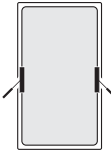





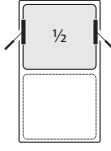
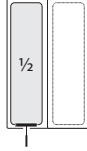

PNC	Model	Ref	Brand	Notes
206352	LIFE7	a	ELX	200MM PASTA COOKER E700
206354	LIFZ7	b	ZAN/OEM	200MM PASTA COOKER E700
206353	LIFE9	c	ELX	200MM PASTA COOKER E900
206355	LIFZ9	d	ZAN/OEM	200MM PASTA COOKER E900

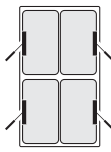
Pag	Index	Indice	Note
2	Components	Componenti	
3	Spare parts list	Lista ricambi	
4	Baskets 700	Cestelli 700	

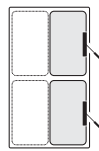
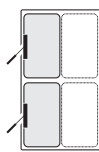
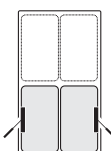

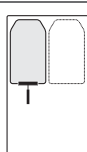
ACCESSORIO SOLLEVAMENTO E700XP / E900XP
LIFTING SYSTEM E700XP / E900XP

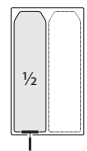
<i>Pos</i>	<i>Factory Code</i>	<i>Spare Code</i>	<i>Descrizione</i>	<i>Description</i>	<i>Ref./Note</i>
1	050489HS02	*	FONDO	BOTTON PANEL	E900
1	050489J202	*	FONDO	BOTTON PANEL	E700
2	0835856900	0C0204	PIEDE	FOOT	
3	050389HJ00	0CB153	FIANCO DESTRO	RIGHT PANEL	E900 ELX
3	050389HL00	0CB154	FIANCO DESTRO	RIGHT PANEL	E900 ZAN/OEM
3	085089L500	*	FIANCO DESTRO	RIGHT PANEL	E700 ELX
3	085089L700	*	FIANCO DESTRO	RIGHT PANEL	E700 ZAN/OEM
4	050389HH00	0CB151	FIANCO SINISTRO	LEFT PANEL	E900 ELX
4	050389HK00	0CB152	FIANCO SINISTRO	LEFT PANEL	E900 ZAN/OEM
4	085089L400	*	FIANCO SINISTRO	LEFT PANEL	E700 ELX
4	085089L600	*	FIANCO SINISTRO	LEFT PANEL	E700 ZAN/OEM
5	050389UD01	*	SCHIENALE	BACK PANEL	
6	0870895601	0C7150	RIPIANO	TABLE TOP	E900 ELX
6	087089MQ00	0C7233	RIPIANO	TABLE TOP	E900 ZAN/OEM
6	087089CK01	0C7219	RIPIANO	TABLE TOP	E700 ELX
6	087089MR00	0C7184	RIPIANO	TABLE TOP	E700 ZAN/OEM
7	050389HN01	0C7365	CRUSCOTTO	CONTROL PANEL	E900 ELX
7	0553881S01	0C7186	CRUSCOTTO	CONTROL PANEL	E700 ELX
8	080589AG02	0C7367	PANNELLO FRONTALE	PANEL	
9	0219812A00	*	COPIGLIA	SPLIT PIN	
10	0548877000	0C7363	MEMBRANA	LAYER	
11	083089F101	0C7364	SUPPORTO CESTELLO	BASKET SUPPORT	E900
11	083089F801	0C7197	SUPPORTO CESTELLO	BASKET SUPPORT	E700
12	0516899D00	0C7359	ASTA	SHAFT	
13	0611808604	0C4721	ATTUATORE	ACCOMPLISHER	
14	0219812801	*	PERNO DI FISSAGGIO	FIXING PIN	
15	0219704305	*	SPINA ELASTICA	FIXING PIN	
16	0511833300	0C5575	ANTIROTAZIONE	ANTI-ROTATION	
17	0511833202	0C5576	BOCCOLA	BUSH	
18	083089DH01	0C7195	SUPPORTO ATTUATORE	ACCOMPLISHER SUPPORT	
19	050489J401	*	SUPPORTO	SUPPORT	2 Motors
19	050489DR01	*	SUPPORTO	SUPPORT	3 Motors
20	050489J301	*	SUPPORTO	SUPPORT	2 Motors
20	050489DP02	*	SUPPORTO	SUPPORT	3 Motors
21	0543821900	0C2496	GUARNIZIONE CRUSCOTTO	GASKET	
22	0640804A00	0C7357	PULSANTE	PUSH BUTTON	
23	0675860F00	0C7361	SCHEDA ELETTRONICA	MAIN BOARD	
24	0652800401	056582	PORTA FUSIBILI	FUSE HOLDER	
25	0652805200	*	FUSIBILE 1,6 A 5X20	FUSE 1,6 A 5X20	5X20
26	0648806900	006610	RELÈ	RELAY	
27	0624805601	006159	TRASFORMATORE	TRASFORMER	
28	0639804900	046357	MORSETTIERA	TERMINAL BOARD	
29	0544802200	0C2328	PRESSACAVO	TOGHTENER CORD	
30	0675830800	006147	RADDRIZZATORE		
31	050489K000		SUPPORTO COMP. ELETTRICI	ELECTRIC COMPONENTS SUPPORT	
	0830857105	0C1340	CESTELLO PASTA	PASTA BASKET	E900 275X150

Spare code	Description	Dimension		
004874	Basket AISI 304 for pastacooker PNC 921611	L = 220 mm P = 350 mm A = 265 mm		
004875	Basket in AISI 304 for pastacooker PNC 921610	L = 220 mm P = 170 mm A = 265 mm		
004873	Lengthwise basket AISI 304 for pastacooker PNC 921619	L = 105 mm P = 350 mm A = 265 mm		
0C9225	Kit, 4 square baskets, AISI 304 for pastacooker (need to work on top code 004876)	L = 105 mm P = 160 mm A = 265 mm		
0C9226	Kit, 2 RIGHT square baskets, AISI 304 for pastacooker (need to work on top code 004876)	L = 105 mm P = 160 mm A = 265 mm		
0C9227	Kit, 2 LEFT square baskets, AISI 304 for pastacooker (need to work on top code 004876)	L = 105 mm P = 160 mm A = 265 mm		
0CA258	Kit, 2 square baskets (left & right) AISI 304 for pastacooker (need to work on top code 004876)	L = 105 mm P = 160 mm A = 265 mm		
006886 206312	Single portion basket, AISI 304 for electronic automatic pastacookers	L = 115 mm P = 163 mm A = 123 mm		
0C9539 206314	Lengthwise basket, AISI 304 for electronic automatic pastacookers	L = 115 mm P = 320 mm A = 123 mm		
004876	False bottom, AISI 304 for pastacooker (Ideal to place baskets code 0C9225)	L = 230 mm P = 350 mm A = 30 mm	